



2017

LIGHTING  
*for you*



LIGHTING  
*for you*

Catalogue 2017





Die mit diesem Symbol gekennzeichneten Katalogartikel sind geschmacks- oder gebrauchsmusterrechtlich registriert • The catalog articles marked with this symbol are registered either for their utility or for their model • Les articles de catalogue marqués avec ce symbole sont enregistrés pour leur utilité ou pour leur modèle • De met dit symbool aangeduide produkten zijn geregistreerd vanwege het model of het gebruik • Los artículos marcados con este símbolo estan registrados como utilidad o como modelo • Gli articoli contrassegnati da questo simbolo sono registrati sia per il loro utilizzo sia per il loro modello • Articolele marcate cu acest simbol sunt înregistrate fie pentru utilitatea lor, fie pentru modelul lor • Luettelon tuotteet, jotka merkitty täällä merkillä, ovat rekisteröity joko käytön tai mallin suojaamiseksi • Artykuły oznaczone tym symbolem zostały zarejestrowane ze względu na ich cechy użytkowe lub model • Bu sembol ile işaretli katalog ürünleri, kullanım amacı veya tasarım olarak koruma altındadır

# Inhaltsverzeichnis

General Index • Index général • Algemene index • Índice general •  
Indice generale • Index general • Yleisindeksi • Ogólny indeks • Genel dizin

Unternehmen • Company Entreprise • Onderneming • Empresa • Azienda • Compania • Yritys • Przedsiębiorstwo • Kurumsal	4
TRIO Smart Control	6
Serienübersicht • Family overview Aperçu par famille • Overzicht per familie • Vista general por familia • Panoramica per famiglia • Prezentare pe familii de produse • Perheen yleiskuvaus • Przegląd rodziny • Ürün Ailesi	8
Produktübersicht • Product overview Aperçu par produit • Overzicht per product • Vista general por producto • Panoramica dei prodotti • Prezentare pe produs • Tuotteen yleiskuvaus • Opis produktu • Ürün İncelemesi	10
Kombinationen • Coordinates Coordonnés • Combinaties • Coordinados • Coordinati • Coordonatele • Koordinaatit • Współrzędne • Koordinatları	32
Vintage	160
Pendelleuchten & Kronen • Pendants & chandeliers Lustres & suspensions • Hanglampen & kroonluchters • Colgantes y Lámparas • Lampadari e sospensioni • Lustre si pendule • Riippu- & kruunu • Wiszące i żyrandole • Avize & Sarkıtlar	186
Spotserien • Spots Spotterie • Spots • Focos • Faretti • Spoturi • Spotit • Reflektorki • Spotlar	240
Wand- und Deckenleuchten • Wall & Ceiling lamps Applique & plafonniers • Wandlampen & plafonnières • Apliques y plafones • Applique e plafoniere • Plafoniere si aplicie • Seinä- & katto • Sufitowe i ścienne • Tavan & Duvar armatürleri	306
Unterbauleuchten • Cabinet lighting Éclairage cuisine et dressing • Keuken- en kastverlichting • Iluminación de cocina y vestidor • Illuminazione cucina e spogliatoio • Iluminat pentru bucatarie si dressing room • Keittiö valaistus • Oprawy meblowe • Kabin aydınlatma	408
Steh- und Tischleuchten • Table- & floor lamps Lampes de table & lampadaires • Tafel- & vloerlampen • Sobremesas y lámparas de pie • Lampade da tavolo e piantane • Veioze si lampadare • Pöytä- & lattia • Stołowe i podłogowe • Lambader & Masa lambaları	414
Badezimmerleuchten • Bathroom lighting Éclairage salle de bains • Badkamer verlichting • Iluminación de cuarto de baño • Illuminazione per bagno • Iluminat baie • Kylpyhuone valaistus • Oświetlenie łazienkowe • Banyo aydınlatma	488
Leuchtmittel • Light sources Ampoules • Lichtbronnen • Fuentes de luz • Lampadine • Becuri • Valonlähteet • Źródła światła • Işık kaynakları	510
Präsentationen • Displays Présentoirs • Displays • Espositores • Espositori • Display-uri • Telineet • Wyświetla • Teşhir	519
Spezifikationen • Specifications Spécifications • Specificaties • Especificaciones • Specifiche • Specificații • Tekniset tiedot • Specyfikacje • Özellikler	530
Produktdaten • Product data Donnés de produit • Product gegevens • Datos de producto • Dati del prodotto • Date de produs • Tuotetiedot • Dane produktu • Ürün Bilgileri	538
Kontakt • Contact Contact • Contact • Contactar • Contatto • Contact • Yhteydenotto • Kontakt • İletişim	565

# Unternehmen

Company • Entreprise • Onderneming • Empresa •  
Azienda • Compania • Yritys • Przedsiębiorstwo • Kurumsal

TRIO wurde im Jahr 1991 im sauerländischen Arnsberg gegründet. In 25 Jahren erfolgreicher Firmengeschichte hat sich unser Unternehmen als einer der führenden Spezialisten für dekorative Wohnraumbeleuchtung etabliert. Innovationskraft, ein hohes Maß an Flexibilität und ausgeprägte Kundennähe sind die Säulen unseres Erfolges.

Mit der Gründung von TRIO INTERNATIONAL im Jahr 2011 wurde der Grundstein für die Internationalisierung gelegt. Mittlerweile agieren wir in über 30 Ländern, dazu zählen Joint Ventures in Italien, Spanien, Skandinavien, der Türkei und neuerdings auch in den USA.

Die TRIO Lighting Group beschäftigt heute insgesamt rund 190 Mitarbeiter. Als modernes und zukunftsorientiertes Unternehmen bieten wir ausgezeichnete Produkte, überragenden Service und weitreichende Fachkompetenz, die nur einem Zweck dienen: den Kunden rundum zufrieden zu stellen.

TRIO was founded in Arnsberg, a town in Germany's Sauerland region, in 1991. In 25 years of successful company history, our company has established itself as one of the leading specialists in decorative home lighting. Innovation, a high degree of flexibility and enhanced customer proximity are the key reasons for our success.

The founding of TRIO INTERNATIONAL in 2011 laid the foundations for the international expansion. We meanwhile operate in more than 30 countries and have joint ventures in, for example, Italy, Spain, Scandinavia, Turkey and as of late in the USA.

TRIO Lighting Group currently has about 190 employees. As a modern and future-oriented company, we offer excellent products, outstanding service and extensive know-how that serve only one purpose, namely to completely satisfy our customers.

TRIO a été fondée en 1991 à Arnsberg dans le Sauerland. Riche de 25 ans d'existence fructueuse, notre entreprise s'est imposée comme l'un des leaders spécialisés dans l'éclairage d'intérieur décoratif. Notre force d'innovation, notre très grande flexibilité et notre grande proximité avec les clients constituent les piliers de notre succès.

La création de TRIO INTERNATIONAL en 2011 a posé les fondations de notre internationalisation. Depuis, nous sommes présents dans plus de 30 pays, avec des coentreprises en Italie, en Espagne, en Scandinavie, en Turquie mais également aux États-Unis plus récemment.

Au total, le groupe TRIO Lighting emploie aujourd'hui environ 190 collaborateurs. En tant qu'entreprise moderne et tournée vers l'avenir, nous proposons d'excellents produits et services ainsi que de nombreuses compétences spécialisées employées dans un seul but : pleinement satisfaire le client.

TRIO werd opgericht in het jaar 1991 in Arnsberg in het Sauerland. Tijdens een succesvolle bedrijfsgeschiedenis van 25 jaar heeft onze onderneming zich gevestigd als één van de toonaangevende specialisten voor decoratieve woningverlichting. Innovatievermogen, maximale flexibiliteit en uitgesproken klantennabijheid zijn de zuilen van ons succes.

Door de oprichting van TRIO INTERNATIONAL in het jaar 2011 werd de basis gelegd voor de internationalisering. Ondertussen ageren wij in meer dan 30 landen, daarbij horen joint ventures in Italië, Spanje, Scandinavië, Turkije en sinds kort ook in de VS.

De TRIO Lighting Group telt momenteel in totaal ongeveer 190 medewerkers. Als moderne en toekomstgerichte onderneming bieden wij uitstekende producten, buitengewone service en uitgebreide vakbekwaamheid met slechts één doel voor ogen: een geheel tevreden klant.

TRIO fue fundada en el año 1991 en Arnsberg, en la región alemana de Sauerland. En 25 años de éxito en la historia de la empresa, esta se ha establecido como uno de los especialistas líderes en iluminación decorativa para el hogar. Fuerza innovadora, una gran flexibilidad y una marcada cercanía al cliente son los pilares de nuestro éxito.

Con la fundación de TRIO INTERNATIONAL en el año 2011, se puso la primera piedra para la internacionalización. Desde entonces, estamos activos ya en más de 30 países, incluyendo empresas conjuntas en Italia, España, Escandinavia, Turquía y, desde hace poco, también los EE. UU.

El grupo TRIO Lighting da empleo en la actualidad a un total aproximado de 190 empleados. Como empresa moderna y orientada al futuro, ofrecemos productos extraordinarios, una asistencia excelente y una amplia competencia técnica, todo esto al servicio de un solo fin: la satisfacción general de los clientes.

TRIO fu fondata nel 1991 ad Arnsberg, nella regione della Renania Settentrionale-Vestfalia in Germania. In 25 anni di successo l'azienda ha guadagnato una posizione tra i produttori leader di illuminazione decorativa domestica. Forza innovativa, elevata flessibilità e spiccato orientamento al cliente sono i pilastri del nostro successo.

Con la fondazione di TRIO INTERNATIONAL nel 2011, l'azienda ha compiuto il primo passo verso l'internazionalizzazione. La nostra presenza si registra ormai in 30 paesi, anche sotto forma di Joint Venture in Italia, Spagna, Scandinavia, Turchia e recentemente anche negli USA.

Il TRIO Lighting Group conta ad oggi complessivamente 190 dipendenti. La nostra azienda moderna e proiettata verso il futuro offre prodotti d'eccellenza, un servizio impeccabile ed estese competenze nel settore con un unico obiettivo: la soddisfazione del cliente.

TRIO a fost înființată în anul 1991 în orașul Arnsberg din regiunea Sauerland. În istoria de succes a firmei care se întinde pe durata celor 25 de ani, compania noastră s-a definit ca fiind unul din liderii specialiștilor pentru iluminatul decorativ al locuințelor. Forța de inovație, un mare grad de flexibilitate și apropierea intensă de client sunt pilioanele succesului nostru.

Prin înființarea TRIO INTERNATIONAL în anul 2011 a fost pusă piatra de temelie pentru globalizare. Între timp acționăm în peste 30 de țări, printre acestea se numără societăți mixte din Italia, Spania, Scandinavia, Turcia și mai nou și din SUA.

TRIO Lighting Group are astăzi în total în jur de 190 angajați. În calitate de companie modernă și orientată spre viitor oferim produse excelente, service performant și competență vastă de specialitate, toate acestea servind unui singur scop: clienți pe deplin mulțumiți din toate punctele de vedere.

TRIO perustettiin vuonna 1991 Keski-Saksan Arnsbergissä. Yrityksen ensimmäinen neljännesvuosisata on ollut menestyksessä, ja se on kohonnut johtavien kodin sisustusvalaistuksen asiantuntijoiden joukkoon. Innovatiivisuus, joustavuus ja asiakaslähtöisyys ovat yrityksen menestyksen tärkeimpiä kulmakiviä.

TRIO INTERNATIONAL -yhtiön perustamisen myötä vuonna 2011 yritys lähti kansainvälisille urille. Tällä hetkellä se toimii yli 30 maassa, ja yhteisyrityksiä on perustettu Italiaan, Espanjaan, Pohjoismaihin, Turkkiin ja viimeisimpänä Yhdysvaltoihin.

TRIO Lighting Groupin palveluksessa on noin 190 henkilöä. Nykyaikainen ja tulevaisuuteen katsova yritys valmistaa laajan asiantuntemuksensa turvin ensiluokkaisia tuotteita ja tarjoaa tyytyväisille asiakkailleen ylivertaista palvelua.

Firma TRIO powstała w 1991 roku w miejscowości Arnsberg w Sauerland. W ciągu 25 lat pełnej sukcesów historii przedsiębiorstwa stało się ono jednym z głównych ekspertów w zakresie dekoracyjnego oświetlenia pomieszczeń mieszkalnych. Innowacyjność, duża wszechstronność oraz bliski kontakt z klientem to filary naszego sukcesu.

Utworzenie przedsiębiorstwa TRIO INTERNATIONAL w 2011 roku stanowiło podwaliny międzynarodowego zasięgu działalności. Dziś jesteśmy obecni w ponad 30 krajach, tworząc spółki joint venture we Włoszech, Hiszpanii, Skandynawii, Turcji, a ostatnio także w USA.

TRIO Lighting Group zatrudnia obecnie około 190 pracowników. Jako nowoczesne i ukierunkowane na przyszłość przedsiębiorstwo oferujemy znakomite produkty, wyjątkową obsługę i szerokie kompetencje specjalistyczne służące tylko jednemu celowi: zadowoleniu klienta.

Trio 1991 yılında Sauerland Arnsberg'de kuruldu. 25 yıllık başarılı şirket tarihinde dekoratif yaşam alanı aydınlatması alanında lider uzman haline geldi. Başarımızın temelleri yüksek ölçüde esneklik ve müşteriye yakınlıktır.

2011 yılında TRIO INTERNATIONAL şirketinin kurulmasıyla birlikte uluslararasılaşmanın da temeli atılmış oldu. Bugün İtalya, İspanya, İskandinavya, Türkiye ve kısa bir süre önce ABD'deki ortak girişimlerimiz dahil olmak üzere 30'dan fazla ülkede faaliyet göstermekteyiz.

TRIO Lighting Group bugün yaklaşık 190 çalışana sahiptir. Modern ve ilerici bir şirket olarak sunduğumuz mükemmel ürünler, üstün hizmet ve geniş kapsamlı uzmanlık tek bir amaca hizmet ediyor: müşterilerin tam memnuniyetini sağlamak.



Wer sein Licht intelligent steuert, kann die Beleuchtung zuhause nicht nur effizient und energiesparend einsetzen, sondern auch verschiedene Lichtquellen ganz bequem seinen individuellen Bedürfnissen anpassen. Je nach Situation sorgt die richtige Lichtstimmung für mehr Wohnkomfort und Atmosphäre. Eine intelligente Lichtsteuerung kann Haus oder Wohnung bereichern. TRIO Smart Control bietet mit CLC (collective light control) eine besonders komfortable Lichtsteuerung. In Kooperation mit dem Lichtforum NRW und namenhaften Leuchtenherstellern haben wir uns für das europaweit führende HomeMatic system entschieden, um einen einheitlichen Standard für intelligente Lichtsteuerung zu gewährleisten. Mit der Homematic-Zentrale ([www.homematic.com](http://www.homematic.com)) oder einer Telecom Home-Base von Qivicon ([www.qivicon.com](http://www.qivicon.com)) funktioniert die Lichtsteuerung ganz einfach per APP über Smartphone oder Tablet. Unabhängig von einer Zentrale lassen sich die Leuchten auch mittels Handsender schalten und dimmen. Aufwendige Installationen, wie z.B. der Austausch von Schaltern sind nicht notwendig! Die gewohnten Schalter bleiben funktionsfähig. Über die Zusammenarbeit mit HomeMatic sind clc-gesteuerte Leuchten zudem Bestandteil einer vielfältigen Hausautomation. So bietet das System die Möglichkeit, die Lichtsteuerung mit anderen Elementen im Haus zu kombinieren, beispielsweise Jalousien, Heizungen, sowie Sicherheits- und Alarmsysteme.

Achten Sie auf das TRIO Smart Control Logo in diesem Katalog.

Intelligent lighting control not only paves the way for the economical, energy-efficient use of lighting in the home, but also allows you to conveniently adapt various sources of light to meet your individual needs. Achieving the right lighting mood for the situation delivers greater home comfort and atmosphere. Intelligent lighting can enhance your house or apartment. TRIO Smart Control offers a very convenient light control with its CLC (collective light control) system. In co-operation with renowned light manufacturers, we chose Europe's leading HomeMatic system in order to ensure a uniform standard for smart light control. The HomeMatic controller ([www.homematic.com](http://www.homematic.com)) or a Telecom Home Base from Qivicon ([www.qivicon.com](http://www.qivicon.com)) makes light control easy via a smartphone or tablet APP. The lights can also be switched and dimmed independently of the controller by using a handheld transmitter. Costly installations, like switch replacement, are not necessary! The normal switches remain functional. Due to the co-operation with HomeMatic, clc lights are an integral part of a versatile home automation. The system allows, for example, the combination of light control with other home elements, such as blinds, radiators, and security and alerting systems. Look out for the TRIO Smart Control Logo in this catalogue.

Une commande d'éclairage intelligente ne permet pas seulement d'utiliser l'éclairage chez soi de manière efficace tout en réalisant des économies d'énergie, mais également d'adapter facilement les diverses sources de lumière à ses propres besoins. Selon la situation, une bonne ambiance lumineuse assure plus de confort intérieur et une meilleure ambiance. Un éclairage intelligent vient enrichir une maison ou un appartement. TRIO Smart Control offre une commande d'éclairage particulièrement confortable grâce au CLC (collective light control). En collaboration avec des fabricants de luminaires renommés, nous avons sélectionné le système HomeMatic, leader européen, pour assurer des normes uniformes en matière de commande d'éclairage intelligente. Avec la centrale HomeMatic ([www.homematic.com](http://www.homematic.com)) ou un Telecom Home-Base de Qivicon ([www.qivicon.com](http://www.qivicon.com)), la commande d'éclairage fonctionne très facilement via l'application pour smartphone ou tablette. Il est également possible d'actionner et de régler les lampes à l'aide d'une télécommande, indépendamment de toute centrale. Aucune installation coûteuse, comme le changement d'interrupteurs, n'est requise ! Les interrupteurs habituels continuent de fonctionner. Grâce à la collaboration avec HomeMatic, les lampes commandées par CLC font, en outre, partie intégrante d'une domotique variée. Ainsi, le système offre la possibilité de combiner la commande d'éclairage avec d'autres éléments de la maison, comme des stores vénitiens, des chauffages, ainsi que des systèmes de protection et d'alarme. Cherchez le logo TRIO Smart Control dans ce catalogue.

Wie licht intelligent stuurt, kan verlichting thuis niet alleen efficiënt en energiebesparend inzetten, maar ook verschillende lichtbronnen gemakkelijk aan individuele behoeften aanpassen. Afhankelijk van de situatie kan de juiste verlichting meer wooncomfort en sfeer creëren. Een intelligente verlichting kan een huis of appartement verrijken. TRIO smart control biedt met CLC (collective light control) een bijzonder comfortabele lichtsturing. In samenwerking met gerenommeerde lampenfabrikanten hebben wij gekozen voor het in heel Europa

toonaangevende HomeMatic systeem om een uniforme standaard voor intelligente lichtsturing te waarborgen. Met de Homematic centrale ([www.homematic.com](http://www.homematic.com)) of een Telecom Home Base van Qivicon ([www.qivicon.com](http://www.qivicon.com)) werkt de lichtsturing heel eenvoudig per app via smartphone of tablet. Onafhankelijk van een centrale kunnen de lampen ook door middel van handzenders bediend en gedimd worden. Omslachtige installaties zoals bijv. de vervanging van schakelaars zijn niet nodig! De vertrouwde schakelaars blijven functioneren. Via de samenwerking met HomeMatic zijn clc-gestuurde lampen bovendien bestanddeel van een veelzijdige huisautomatisering. Zo biedt het systeem de mogelijkheid om de lichtsturing met andere elementen in het huis te combineren, bijvoorbeeld rolluiken, verwarming alsook veiligheids- en alarmsystemen. Let op het TRIO smart control logo in deze catalogus.

Quien controla su iluminación de manera inteligente, no solo puede administrar la iluminación de su hogar de forma eficiente y ahorrativa, sino adaptar diversas fuentes de luz convenientemente a sus necesidades individuales. Con un efecto de iluminación adecuado a cada situación es posible crear mayor bienestar habitacional, confort y calidad de vida. Una iluminación inteligente puede enriquecer una casa o un apartamento. TRIO Smart Control ofrece con el CLC (control de luces colectivo) un control de la iluminación especialmente cómodo. En cooperación con fabricantes de luces de renombre, hemos optado por el sistema HomeMatic, líder a nivel europeo, para garantizar un estándar único para el control de luces inteligente. Con la central de Homemati ([www.homematic.com](http://www.homematic.com)) o una base de telecomunicaciones de Qivicon ([www.qivicon.com](http://www.qivicon.com)), el control de luces funciona de forma muy sencilla a través de una aplicación para smartphones o tablets. Independientemente de la central, las luces pueden encenderse y oscurecerse también mediante emisores manuales. ¡No son necesarias instalaciones complicadas, por ejemplo para el cambio de interruptores! Los interruptores habituales siguen funcionando. A través de la colaboración con HomeMatic, las luces con control CLC también forman parte de una automatización doméstica variada. De este modo, el sistema ofrece la posibilidad de combinar el control de las luces con otros elementos del hogar, como persianas, calefacciones y sistemas de seguridad y alarmas. Preste atención al logo de TRIO Smart Control en este catálogo.

Controllare in modo intelligente la luce significa non solo poter illuminare la propria abitazione in modo efficiente e senza sprechi di energia, ma anche modulare le diverse fonti di luce per adattare alle proprie esigenze nel massimo del comfort. A seconda della situazione, può essere opportuno regolare l'illuminazione per trovare l'intensità più giusta a creare il comfort e l'atmosfera che desideriamo. Un'illuminazione controllata in modo intelligente può valorizzare la tua casa o il tuo appartamento. Con il CLC (collective light control) il controllo dell'illuminazione offerto da TRIO Smart Control è pratico e semplice. In collaborazione con rinomati produttori di luci, abbiamo deciso di adottare il sistema leader a livello europeo HomeMatic al fine di garantire uno standard uniforme per l'illuminazione intelligente. Con la centralina HomeMatic ([www.homematic.com](http://www.homematic.com)) o un Telecom Home-Base di Qivicon ([www.qivicon.com](http://www.qivicon.com)), controllare l'illuminazione diventa facilissimo tramite applicazione per Smartphone o Tablet. Il controllo delle luci non è vincolato alla centralina: è possibile infatti spegnere e regolare l'intensità delle luci anche con il telecomando. Non è necessario apportare modifiche dispendiose, come ad esempio la sostituzione degli interruttori! Gli interruttori esistenti rimarranno funzionanti. Grazie alla collaborazione con HomeMatic, le luci controllate diventano uno degli elementi di un sistema multifunzionale per la completa automazione dell'abitazione. Questo sistema offre infatti la possibilità di combinare il controllo dell'illuminazione con altri elementi dell'abitazione, ad esempio veneziane, riscaldamenti nonché sistemi di sicurezza e di allarme. Cercate il logo TRIO Smart Control in questo catalogo.

Cine își controlează inteligent lumina, poate utiliza nu numai eficient și cu economie de energie iluminatul acasă, ci poate și adapta extrem de comod la necesitățile sale individuale diferite surse de lumină. În funcție de situație, reglarea corectă a luminii are grijă pentru mai mult confort al locuinței și pentru atmosferă. O iluminare inteligentă poate însufleți casa sau locuința. TRIO Smart Control oferă împreună cu CLC (collective light control) un control extrem de confortabil al luminii. În cooperare cu producători de renume de corpuri de iluminat ne-am decis pentru sistemul HomeMatic – lider în Europa, pentru a garanta un standard unitar pentru controlul inteligent al luminii. Cu centrala Homematic ([www.homematic.com](http://www.homematic.com))





MAGENTA  
SmartHome

com) sau un sistem Telecom Home-Base de la Qivicon ([www.qivicon.com](http://www.qivicon.com)), controlul luminii funcționează extrem de simplu prin aplicația pentru smartphone sau tabletă. Independent de o centrală, corpurile de iluminat pot fi oprite sau pot fi reglate gradat privind luminozitatea și cu ajutorul unei telecomenzi manuale. Instalările costisitoare, ca de ex. înlocuirea întrerupătoarelor nu sunt necesare! Întrerupătoarele obișnuite rămân apte de funcționare. Prin colaborarea cu HomeMatic corpurile de iluminat controlate prin clc sunt parte componentă a unei automatizări diverse a casei. Astfel sistemul oferă posibilitatea, de a combina controlul luminii cu alte elemente din casă, de exemplu jaluzele, încălzire precum și sisteme de securitate și alarmă. Fiți atenți la logo-ul TRIO Smart Control din acest catalog.

Ohjaamalla kodin valaistusta älykkäästi siitä saadaan tehokas ja energiaa säästävä, mutta samalla erilaisia valonlähteitä on helppo mukauttaa yksilöllisiin tarpeisiin ja toiveisiin. Tunnelmaltaan oikeanlainen valaistus tuo asumisen mukavuutta kaikkiin tilanteisiin. Älykäs valaistus voi olla kodin viihtyisyyden kannalta merkittävä lisä. TRIO Smart Control on CLC-lähestymistavan (collective light control) ansiosta erityisen mukava valaistusohjauksen menetelmä. Yhteistyössä muiden johtavien valaisinvalmistajien kanssa olemme valinneet älykkääseen valaistusohjaukseen HomeMaticin yhtenäisen standardin aikaansaamiseksi. Valaistusta voi ohjata kätevästi älypuhelin- tai tablettisovelluksella Homematic-ohjauskeskuksen ([www.homematic.com](http://www.homematic.com)) tai Qivicon-kotiaseman ([www.qivicon.com](http://www.qivicon.com)) kautta. Valaisimia voi kytkeä päälle ja pois päältä sekä himmentää aina myös kauko-ohjaimella keskukselta riippumatta. Vaivalloisia asennustöitä, kuten katkaisinten vaihtoa, ei tarvita, vaan järjestelmää voi käyttää nykyisten katkaisinten yhteydessä. HomeMatic-järjestelmäyhteistyön ansiosta CLC-ohjatuista valaisimista tulee osa monipuolista kotiautomaatiojärjestelmää. Järjestelmä tarjoaa mahdollisuuden yhdistää valaistusohjauksen talon muihin tekniikkiin ratkaisuihin, kuten kaihtimiin, lämmitykseen tai turva- ja hälytysjärjestelmiin. Tarkkaile TRIO Smart Control -logoa tässä katalogissa.

Kto chce inteligentnie sterować swoim światłem, może używać oświetlenia w swoim domu nie tylko w sposób wydajny i energooszczędny, ale również bardzo wygodnie dostosować różne źródła światła do swoich indywidualnych potrzeb. W zależności od sytuacji właściwy nastrój światła zapewnia więcej komfortu mieszkania i dba o odpowiednią atmosferę. Inteligentne oświetlenie może wzbogacić dom lub mieszkanie. TRIO Smart Control to wyjątkowy komfort sterowania dzięki technologii CLC (collective light control). We współpracy ze znanymi producentami lamp zdecydowaliśmy się na najpopularniejszy w Europie system HomeMatic, aby zapewnić jednolity standard w zakresie inteligentnego sterowania oświetleniem. Centrala Homematic ([www.homematic.com](http://www.homematic.com)) lub Telecom Home-Base marki Qivicon ([www.qivicon.com](http://www.qivicon.com)) umożliwiają sterowanie oświetleniem za pomocą odpowiedniej aplikacji na smartfonie lub tablecie. Niezależnie od centrali można także włączać lub ściemniać lampy za pomocą pilota. Rozwiązanie to umożliwia rezygnację z rozbudowanych instalacji czy np. wymiany przełączników. Standardowe przełączniki zachowują swoją funkcję. Dodatkowo dzięki współpracy z HomeMatic lampy sterowane za pomocą CLC są elementem kompleksowej automatyki w domu. System oferuje możliwość połączenia sterowania oświetleniem z innymi elementami w domu, na przykład z żaluzjami, ogrzewaniem, a także systemami bezpieczeństwa i systemami alarmowymi. Należy szukać logo TRIO Smart Control w tym katalogu.

İşğini akıllıca yöneten, evindeki aydınlatmasını sadece etkili ve tasarruflu kullanmaz aynı zamanda farklı ışık kaynaklarını bireysel ihtiyaçlarına uygun hale getirir. Duruma göre, doğru aydınlatma efekti daha fazla yaşam konforu ve atmosferi sağlar. Akıllı bir aydınlatma evinizi veya dairenizi zenginleştirir. CLC (collective light control) ile birlikte TRIO Smart Control son derece konforlu bir ışık kumandası sağlar. Ünlü lamba üreticileri ile işbirliği içinde akıllı ışık kumandasında üniter bir standart sağlamak için Avrupa genelinde lider olan HomeMatic sisteminde karar kıldık. Homematic merkezi ([www.homematic.com](http://www.homematic.com)) veya Qivicon marka bir Telecom Home-Base ([www.qivicon.com](http://www.qivicon.com)) ile ışık kumandası APP ile akıllı telefon veya tablet bilgisayarla kolayca çalışmaktadır. Bir merkezden bağımsız olarak lambalar bir el vericisi ile de açılabilir ve kısılabilmektedir. Örneğin düğmelerin değiştirilmesi gibi masraflı kurulumlar gerekli değildir! Akıllı düğmeler işlev görmeye devam eder. HomeMatic ile işbirliği içinde clc kumandalı lambalar çok çeşitli bina otomasyonunun bir bileşeni haline gelmiştir. Sistem bu şekilde ışık kumandasını evdeki örneğin jaluzele, kalorifer, güvenlik ve alarm sistemleri gibi diğer elemanlarla kombinasyon olanağı sunmaktadır.

Bu katalogdaki TRIO Smart Control logosuna dikkat edin.



# Serienübersicht

Family overview • Aperçu par famille • Overzicht per familie • Vista general por familia • Panoramica per famiglia •  
Prezentare pe familii de produse • Perheen yleiskuvaus • Przegląd rodziny • Ürün Ailesi

Aaron	130	Boston	212	Clinton	62	Duellant	80	Gonzalo	363
Aberdeen	395	Bowie	304	Colin	232	Dylan	297	Gracia	156
Adrian	378	Brandon	490	Colino	332	Ecco	413	Grandeur	329
Adriano	394	Brentano	461	Cologne	394	Eclipse	323	Grannus	233
Airlight	401	Brian	491	Colorit	138	Edison	124	Greta	215
Alabaster	321	Bruno	460	Columbus	52	Edison II	222	Halifax	50
Alba	377	Bulto	379	Como	423	Eik	477	Hamar	507
Alino	411	Busa	382	Compo	496	Elias	200	Havanna	250
Alvaro	360	Buttello	494	Concorde	355	Elsa	168	Helen	492
Amsterdam	456	Calais	220	Concrete	180	Embassy	372	Henk	476
Andrea	381	Calgary	417	Concus	508	Espejo	382	Highway	94
Anna	178	Calvaro	196	Congress	354	Esprit	346	Hotel	141
Antonio	328	Campino	496	Cono	402	Eudura	406	Hugo	507
Antwerp	436	Campo	374	Contender	357	Eurico	509	Icaro	454
Apart	505	Cancun	244	Converter	356	Eva	118	Iker	353
Aragon	411	Cannes	144	Corland	88	Evans	421	Inesto	406
Arango	420	Canturo	337	Corland II	274	Facella	402	Irene	182
Arizona	419	Cantus	216	Cormint	383	Facette	367	Jackson	300
Arko	462	Capital	152	Cornet	358	Farina	182	Jana	182
Ary	481	Carbonado	380	Coronado	106	Figaro	84	Janko	179
Astrid	170	Carico	286	Cosinus	146	Filigran	446	Jasmin	184
Atlanta	324	Carlos	379	Cristalina	367	Fisherman	172	Jasper	116
Aurora	318	Cartney	258	Cristo	475	Fix	407	Joel	362
Avenue	192	Casco	423	Cuadro	386	Flesso	495	Jones	294
Avignon	272	Casillas	352	Cubo	498	Flexo	470	Joost	479
Baco	463	Cassini	82	Curtis	388	Florence	440	Jordi	508
Baloubet	273	Catoki	104	Curva	370	Florestan	424	Juan	331
Basel	70	Catoki II	107	Danillo	506	Florian	412	Judith	176
Basic	273	Cavallo	197	Darian	500	Floris	381	Juri	158
Beijing	416	Cayman	252	Dario	330	Foxi	407	Kannan	217
Berta	171	Celia	399	Davi	483	Freddy	292	Kingston	34
Bianca	376	Cento	365	Denver	74	Frieda	164	Kolian	501
Big Apple	122	Charles	284	Diego	234	Future	339	Kolibri	469
Birdy	166	Chiara	223	Disc	371	Fynn	478	Kowloon	313
Birte	174	Chico	385	Divo	405	Gent	438	Kyoto	344
Bolero	392	Clapton	246	Dorian	326	Gerrit	477	Lacan	136
Bolou	276	Clarimo	504	Dover	221	Gian	503	Lacapo	390
Bolsa	493	Classico	227	Drops	202	Godi	509	Lana	384



Landino	132	Miami	459	Pareto	466	Salim	442	Torino	327
Landor	432	Milano	320	Patrice	506	Salinero	190	Tornesh	126
Lentin	368	Milton	44	Pear	473	Sam	503	Toronto	68
Lentin II	333	Miquel	308	Perez	428	Samurai	347	Toulon	120
Levisto	229	Miro	404	Piet	487	Sandro	86	Trevor	115
Leyla	150	Modena	64	Pilatus	270	Sanero	455	Tube	482
Liège	434	Moni	162	Pinwheel	154	Sanna	167	Ultimo	225
Ligara	406	Mons	444	Pirlo	471	Santiago	310	Umbrella	309
Linaro	359	Montender	226	Platon	336	Santo	422	Valeria	398
Linda	176	Monti	475	Plucino	288	Santo II	418	Valerio	398
Lips	393	Montreal	205	Polly	463	Saturn	188	Vancouver	43
Liria	506	Morrison	305	Pontius	270	Seattle	425	Vario	467
Livello	498	Morten	481	Portofino	58	Senator	194	Ventura	472
Lopez	421	Nabab	217	Presley	248	Seoul	322	Victor	228
Lordanos	346	Nadir	468	Preto	468	Seta	482	Victoria	157
Loris	460	Nagoya	347	Primo	385	Shanghai	426	Viola	232
Luca	224	Nando	503	Pronto	471	Shogun	348	Vita	404
Lucas	351	Naples	206	Pyramid	334	Sidney	60	Voltaire	199
Lucia	377	Narcos	254	Quidam	108	Silas	72	Wales	397
Lucio	462	Nevio	497	Quinta	375	Simeo	408	Wim	487
Luis	480	Nicolas	361	Ramiro	204	Slash	216	Windsor	45
Lupo	464	Nilo	500	Ramon	412	Sofia	235	Xavi	509
Madrid	264	Nivel	498	Ramses	209	Sola	429	Yokohama	342
Maira	163	Nora	384	Rani	507	Stakkato	201	Zenit	318
Mamba	110	Olivia	400	Ratio	237	Stamina	230	Zeus	364
Maniac	214	Ontario	38	Reflon	502	Stratos	148	Zidane	262
Manuel	362	Opium	98	Rennes	273	Swan	458	Zinedine	455
Marcos	350	Oslo	193	Reposa	314	Sweety	134	Zucca	236
Margit	169	Ottawa	210	Rey	478	Swirl	224		
Marian	400	Oval	398	Roco	400	Tajo	470		
Marius	92	Pacco	366	Roddik	218	Tanja	167		
Marley	302	Pageno	366	Roderic	452	Teano	54		
Marlon	296	Palo	450	Romino	112	Techno	260		
Marta	405	Palo	450	Romino II	208	Thunder	46		
Mats	486	Palo II	451	Rotario	396	Till	483		
Matteo	198	Paper	238	Ruben	312	Tokyo	345		
Mayan	410	Parabol	474	Rustica	129	Toledo	466		
Mercury	298	Paradox	242	Salido	454	Torcia	403		

# Pendelleuchten & Kronen

Pendants & chandeliers • Lustres & suspensions • Hanglampen & kroonluchters • Colgantes y Lámparas • Lampadari e sospensioni • Lustre si pendule • Riippu- & kruunu Wiszące i żyrandole • Avize & Sarkıtlar



Ontario 35



Ontario 38



Ontario 36



Ontario 42



Kingston 34



Windsor 44



Toulon 120

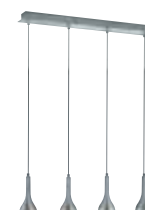

Drops 202



Dover 221



Calais 220



Rodikk 218



Edison 124



Saturn 188



Sidney 60



Portofino 56



Basel 71



Toronto 67



Toronto 69



Salinero 190

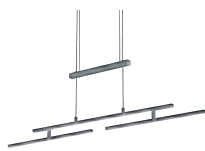

Highway 95



Silas 72



Sandro 86

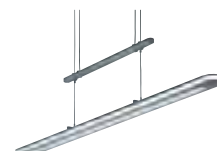

Modena 64



Marius 93



Calvaro 196



Coronado 106



Cavallo 197



Senator 194

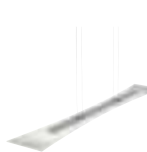

Elias 201



Denver 74



Clinton 62

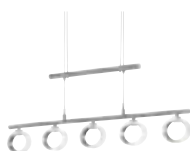

Corland 88

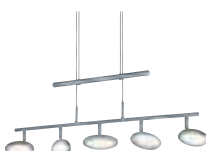

Duellant 79



Paradox 242



Opium 97



Pilatus 101

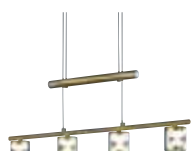

Cassini 83



Carico 287



Presley 248



Jones 294



Freddy 292



Levisto 229



Ontario 36



Ontario 40



Edison II 222

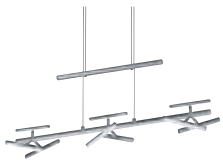

Figaro 84



Columbus 52



Halifax 50



Avenue 192



Teano 54



Oslo 193



Stakkato 200



Voltaire 199



Matteo 198

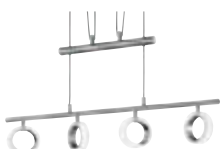

Corland II 274



Bolou 276

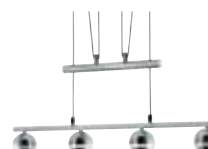

Baloubet 281



Aaron 131

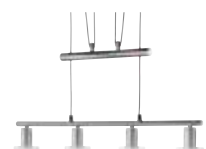

Victor 228

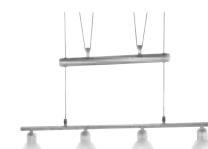

Stamina 230



# Pendelleuchten & Kronen

Pendants & chandeliers • Lustres & suspensions • Hanglampen & kroonluchters • Colgantes y Lámparas • Lampadari e sospensioni • Lustre si pendule • Riippu- & kruunu Wiszące i żyrandole • Avize & Sarkıtlar



Ramiro 204



Montreal 205



Romino 113



Romino II 208



Ramses 209



Naples 204



Slash 216



Cantus 216



Kannan 217



Nabab 217



Maniac 214



Ottawa 210



Hotel 141



Stratos 148



Cannes 144



Hotel 140



Colorit 138



Leyla 151



Rustica 128



Rustica 129



Tornesh 127



Classico 227



Margit 169



Judith 176



Fisherman 172



Moni 162



Maira 163



Frieda 164



Eva 118



Irene 182



Pinwheel 155



Ultimo 225



Luca 224



Thunder 46



Swirl 224



Capital 153



Landino 132



Lacon 136



Zucca 236



Paper 238



Sweety 134



Carbonado 235



Boston 212



Greta 215



Jasper 116



Ratio 237



Trevor 115



Chiara 223



Cosinus 146



Grannus 232



Astrid 170



Berta 171



Birte 174



Birte 177



Elsa 168



Jasmin 184



Birdy 166



Sanna 166



Tanja 167



Victoria 157



Gracia 156



Montender 226



Viola 233



Colin 233



Diego 234



Sofia 235

# Spotserien

Spots • Spotterie • Spots • Focos • Faretti • Spoturi • Spotit • Reflektorki • Spotlar



Havana 250



Duellant 80



Cassini 82



Clapton 246



Presley 248



Cancum 244



Cayman 252



Narcos 254



Techno 260



Cartney 258



Zidane 262



Concrete 180



Paradox 242



Pontius 266



Pilatus 268



Corland II 274



Madrid 264



Opium 98



Bolou 276



Baloubet 280



Marley 302



Bowie 304



Jackson 300



Dylan 297



Jones 294



Levisto 290



Freddy 292



Mercury 298



Marlon 294



Charles 284



Ligara 406



Eudura 406



Inesto 406



Denver 77



Corland 91



Carico 286



Plucino 288



Morrison 305



*Narcos*

Seite/page 254



# Wandleuchten

Wall lamps • Appliques • Wandlampen • Apliques • Appliques •  
Lämpi de perete • Seinävalaisimet • Scienne • Duvar aydınlatma



Portofino 59



Sandro 86



Marius 92



Columbus 52



Mamba 110



Teano 54



Grandeur 329



Clinton 62



Juan 331



Colino 332



Platon 336



Canturo 337



Aberdeen 395



Roco 400



Wales 397



Lacapo 390



Toronto 68



Eclipse 323



Valerio 398



Valeria 398



Adriano 394



Cologne 394



Marian 400



Casillas 352



Frieda 164

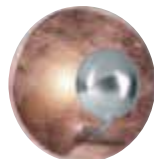

Aurora 318



Lips 393



Bolero 392



Tornesh 126



Campo 374



Cannes 144



Hotel 142



Celia 399



Olivia 400



Toulon 120



Vita 404



Capital 152



Bianca 376



Carbonada 380



Cormit 383



Sweety 134



Atlanta 325



Basel 70



Antonio 328



Pyramid 334



Denver 76



Rotario 396



Oval 398



Quidam 108



Airlight 401



Cuadro 386



Curtis 388



Facella 402



Cono 402



Torcia 403



Miro 404



Divo 405



Marta 405



## Wandleuchten

Wall lamps • Appliques • Wandlampen • Appliques • Appliques •  
Lämpö de perete • Seinävalaisimet • Scienne • Duvar aydınlatma



Buttello 494



Flesso 495



Brandon 490



Brian 491



Helen 492



Cubo 498



Reflox 502



Hugo 507



Hamar 507



Rani 507



Liria 506



Danillo 506



Kolian 501



Darlan 500



Nilo 500



Xavi 509



Eurico 509

## Unterbauleuchten

Cabinet lighting • Éclairage cuisine et dressing • Keuken- en kastverlichting • Iluminación de cocina y vestidor •  
Illuminazione cucina e spogliatoio • Iluminat pentru bucatarie si dressing room • Keittiö valaistus •  
Oprawy meblowe • Kabin aydınlatma



Mayan 410



Simeo 408



Aaragon 411



Alino 411



Florian 412



Ramon 412



Bolsa 493



Nevio 497



Campino 496



Patrice 318

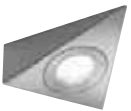

Ecco 413



# Deckenleuchten

Ceiling lamps • Plafonniers • Plafonnières • Plafones •  
Plafoniere • Plafoniere • Kattvalaisimet • Plafony • Plafonyer



Yokohama 342



Tokyo 345



Kyoto 344



Lordanos 346



Esprit 346



Nagoya 347



Future 338



Marcos 350



Lucas 351



Denver 340



Iker 353



Congress 354



Linaro 359



Converter 356



Contender 357



Cornet 358



Manuel 362



Joel 362



Umbrella 309

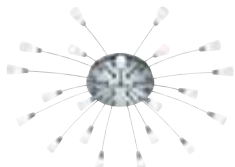

Miquel 308

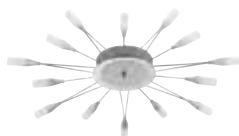

Ruben 312



Santiago 310



Pilatus 102



Reposa 314



Kowloon 313



Toronto 68



Sidney 61



Sandro 87

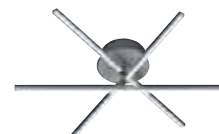

Highway 94



Corland 89



Catoki II 107

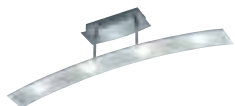

Dario 330



Silas 73



Denver 76



Figaro 84



Basel 70

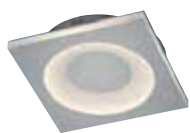

Atlanta 324

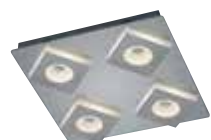

Atlanta 324



Pontius 267



Canturo 337



Antonio 328



Clinton 62





Shogun 348

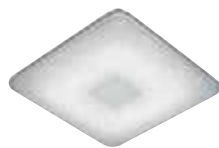

Samurai 349



Concorde 355



Alvaro 360



Nicolas 361



Gonzalo 363

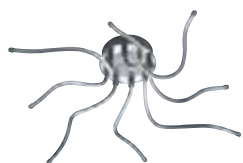

Portofino 58



Halifax 50



Columbus 53



Coronado 106



Catoki 999

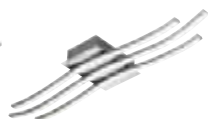

Catoki 104



Modena 65



Opium 98



Havanna 250



Grandeur 329



Dorian 326



Dorian 326



# Samurai

Seite/page 347





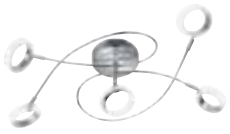

Corland II 274



Baloubet 280



Charles 284



Lentin II 333



Lentin 368

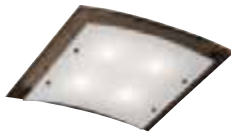

Casillas 352



Romino 112



Zenith 319



Cristalina 367



Facette 367



Pageno 366



Paco 366



Zeus 364



Cento 365

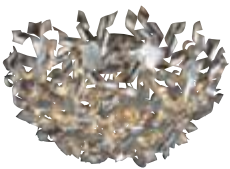

Pinwheel 154



Adrian 378



Campo 374



Quinta 375



Rustica 128



Carlos 379



Chico 385



Nora 384



Lana 384



Apart 505



Bolsa 493



Cubo 498



Nevio 497



Clarimo 504



Sam 503



Compo 496

# Tischleuchten

Table lamps • Lampes de table • Tafellampen • Sobremesas •  
Lampa da tavolo • Veioze • Pöytävalaisimet • Lampy stołowe • Masa lambaları



Thunder 47



Sidney 61



Portofino 56



Toronto 66



Halifax 50



Figaro 84



Mons 444



Columbus 52



Opium 96



Cassini 82



Teano 54



Marius 92



Corland 90



Catoki 105



Parabol 474



Pilatus 100



Mamba 111



Trevor 115



Pear 473



Ventura 472



Milton 44



Big Apple 122



Kingston 34



Capital 152



Cannes 144



Florence 440



Stratos 148



Hotel 141



Landor 432



Colorit 139



Liège 434



Antwerp 436



Gent 438



Janko 179



Linda 176



Astrid 170



Eva 118



Frieda 164



Salim 442



Anna 178



Jana 183



Farina 187



Denver 74



Duellant 78



Catoki 105



Leyla 150



Cosinus 147



Mats 486



Piet 487



Wim 487



Birte 175



Jasmin 184



*Pear*

Seite/page 473

# Tischleuchten

Table lamps • Lampes de table • Tafellampen • Sobremesas •  
Lampa da tavolo • Veioze • Pöytävalaisimet • Lampy stołowe • Masa lambaları



Miami 459



Swan 458



Amsterdam 456



Roderic 453



Brentano 461



Loris 460



Lupo 464



Toledo 466



Pareto 466



Kolibri 467



Preto 468



Arko 462



Filigran 446



Palo 450



Palo II 451



Techno 261



Narcos 254



Zidane 262



Jasper 117



Pirlo 471



Nadir 468



Tajo 470



Pronto 471



Flexo 470



Toulon 121



Edison 124



Eik 477



Joost 479



Luis 480



Monti 475



Fynn 478



Rey 478



Cristo 475



Morten 481



Ary 481



Tubo 482



Rustica 129



Aaron 130



Henk 476



Gerrit 477



Landino 133



Sweety 134



Lucio 462



Vario 469



Bruno 460



Baco 463



Polly 463



Bolou 276



Baloubet 281



Freddy 293



Till 483



Davi 483



Juri 158



Seat 482



Sweety 134

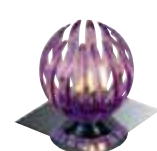

Zucca 484



Lacan 136

# Miami

Seite/page 459



# Stehleuchten

Floor lamps • Lampadaires • Vloerlampen • Lámparas de pie •  
Piantane • Lampadare • Lattiavalaisimet • Lampy podłogowe • Lambaderler



Beijing 416



Teano 55



Toronto 66



Calgary 417



Evans 421



Arizona 419



Casco 423



Santo 422

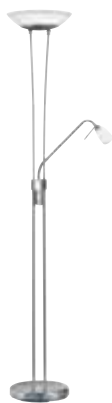

Lopez 421



Seattle 425



Duellant 78



Corland 88



Clapton 447



Narcor 254



Techno 261



Marley 303



Zinedine 455



Zidane 449



Columbus 53

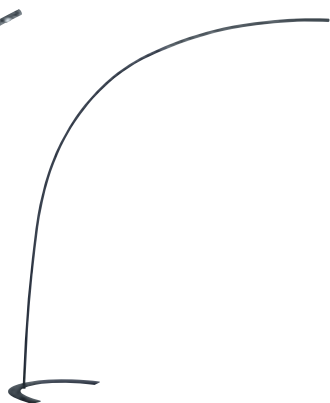

Shanghai 426



Sidney 61



Portofino 56



Teano 55



Halifax 50





Santo II 418



Arango 420



Como 423



Quidam 108



Cassini 82



Opium 96



Denver 74



Marius 92



Catoki 104



# Sidney

Seite/page 61



# Stehleuchten

Floor lamps • Lampadaires • Vloerlampen • Lámparas de pie •  
Piantane • Lampadare • Lattiavalaisimet • Lampy podłogowe • Lambaderler



Florestan 424

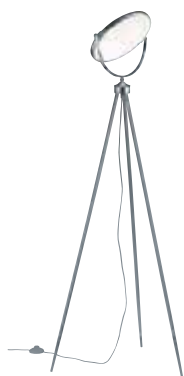

Mons 444



Baloubet 281



Freddy 293



Baloubet 281



Freddy 293



Jasper 117



Icaro 454



Salido 454



Sanero 455



Roderic 452



Juri 158



Sola 429



Perez 428

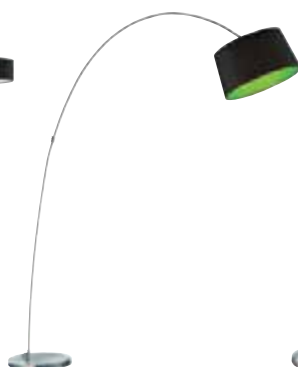

Colorit 430



Hotel 143



Landor 432



Hotel 142



Liège 434



Antwerp 436



Gent 438



Janko 179



Salim 442



Rustica 129



Filigran 446



Palo II 451



Palo 450



Pilatus 100



Mamba 999



Trevor 115



Toulon 120



Edison 214



Capital 152



Cannes 144



Cosinus 146



Leyla 150



Stratos 148



Florence 440



Rustica 129



Tornesh 126







## Kombinationen

Coordinates  
Coordonnés  
Combinaties  
Coordinados  
Coordinati  
Coordonatele  
Koordinaatit  
Współrzędne  
Koordinatları



## Kingston

Glas • glass •  
verre • glas • vidrio • vetro • sticla • lasi • szkło • cam



↑ 150 cm, Ø 35 cm  
excl. 1 x E27, max. 60 W

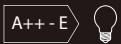

315300106



↑ 150 cm, Ø 20 cm  
excl. 1 x E14, max. 40 W

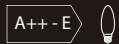

315390106



↑ 30,5 cm, Ø 20 cm  
excl. 1 x E14, max. 40 W



515300106





## Ontario

Glas • glass •  
verre • glas • vidrio • vetro • sticla • lasi • szkło • cam



↑ 155 cm, Ø 51 cm  
excl. 1 x E27, max. 60 W

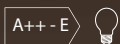

315200131



↑ 150 cm, Ø 33 cm  
excl. 1 x E27, max. 60 W

A++-E

305200101



↑ 150 cm, Ø 18 cm  
excl. 1 x E14, max. 40 W

A++-E

305290101



↔ 80 x 18 cm, ↑ 150 cm  
excl. 3 x E14, max. 40 W

A++-E

305200301



## Ontario

Glas • glass •  
verre • glas • vidrio • vetro • sticla • lasi • szkło • cam







38

## Ontario

Glas • glass •  
verre • glas • vidrio • vetro • sticla • lasi • szkło • cam



↑ 155 cm, Ø 51 cm  
excl. 1 x E27, max. 60 W

A++-E



315200109  
315200179  
315200189

09 kupferfarbig • copper  
79 goldfarbig • gold  
89 silberfarbig • silver









## Ontario

Glas • glass •  
verre • glas • vidrio • vetro • sticla • lasi • szkło • cam

Made in

Europe



↓ 150 cm, Ø 33 cm  
excl. 1 x E27, max. 60 W

A++-E

305200179



↓ 150 cm, Ø 18 cm  
excl. 1 x E14, max. 40 W

A++-E

305290179



↔ 80 x 18 cm, ↓ 150 cm  
excl. 3 x E14, max. 40 W

A++-E

305200379



# Ontario

Glas • glass •  
verre • glas • vidrio • vetro •  
sticla • lasi • szkło • cam



42



↑ 155 cm, Ø 33 cm  
excl. 1 x E27, max. 60 W



305200189



↑ 150 cm, Ø 18 cm  
excl. 1 x E14, max. 40 W



305290189



↔ 80 cm, ↑ 150 cm  
excl. 3 x E14, max. 40 W



305200389



89

# Vancouver

Glas • glass •  
verre • glas • vidrio • vetro • sticla • lasi • szkło • cam



79

43



↑ 8,5 cm, Ø 50 cm  
incl. SMD, 30 W  
2.580 lm, 3.000 K



656813079  
656813089



↑ 8,5 cm, Ø 40 cm  
incl. SMD, 20 W  
1.720 lm, 3.000 K



656812079  
656812089



79 goldfarbig • gold  
89 silberfarbig • silver



# Milton

Glas • glass •  
verre • glas • vidrio • vetro • sticla • lasi • szkło • cam



88

01

00

62

44



↑ 23 cm, Ø 15 cm  
excl. 1 x E14, max. 40 W



515500100  
515500101  
515500162  
515500188

00 transparent • transparent  
01 weiß • white  
62 kupferfarbig antik • copper-coloured antique  
88 silber antik • antique silver





## Windsor

Glas • glass •  
verre • glas • vidrio • vetro • sticla • lasi • szkło • cam



↑ 150 cm, Ø 37 cm  
excl. 1 x E27, max. 60 W

A++ - E

315400162  
315400188



↑ 150 cm, Ø 20 cm  
excl. 1 x E27, max. 60 W

A++ - E

315490162  
315490188



**62** kupfer antik • antique copper  
**88** silber antik • antique silver



Ø 30 cm, ↓ 150 cm  
incl. SMD, 9 W  
800 lm, 3.000 K



325113005



Ø 40 cm, ↓ 150 cm  
incl. SMD, 11 W  
1.000 lm, 3.000 K



325114005



Ø 20 cm  
incl. SMD, 4 W  
370 lm, 3.000 K



525112005



Ø 30 cm  
incl. SMD, 9 W  
800 lm, 3.000 K



525113005

# Thunder

Aluminiumgeflecht • aluminium meshwork •  
maillage aluminium • aluminium vlechtwerk • malla de aluminio •  
reticolo alluminio • impletitura aluminium • alumiiniverkko •  
aluminium koronka • alüminyum örgü





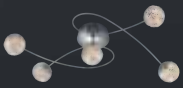

↔ 73,5 x 75,2 cm, ↓ 20,5 cm  
incl. 5 x SMD, 3 W  
5 x 200 lm, 3.000 K

A+

625110505



↔ 80 x 40 cm, ↓ 20,5 cm  
incl. 6 x SMD, 3 W  
6 x 200 lm, 3.000 K

A+

625110605



## Thunder

chrom, Aluminiumgeflecht • chrome, aluminium meshwork •  
chrome, maillage aluminium • chrom, aluminium vlechtwerk •  
cromo, malla de aluminio • cromo, reticolo alluminio •  
chrom, impletitura aluminium • kromi, alumiiniverkko •  
chrom, aluminium koronka • krom, alüminyum örgü







# Halifax

Nickel matt • matt nickel •  
 nickel mat • nikkell mat • níquel mate • nichel opaco •  
 nichel mat • harjattu teräs • nikiel mat • mat nikel



↔ 117,5 cm, ↑ 150 cm  
 incl. 7 x SMD, 3,2 W  
 7 x 300 lm, 3.000 K



378390707



↔ 65,5 x 41 cm, ↑ 6 cm  
 incl. 6 x SMD, 3,2 W  
 6 x 300 lm, 3.000 K



678310607  
 C 678310607 Smart control



↑ 150 cm, Ø 22,5 cm  
 incl. 6 x SMD, 3,2 W  
 6 x 300 lm, 3.000 K



478390607



↑ 59 cm, Ø 15 cm  
 incl. 3 x SMD, 3,2 W  
 3 x 300 lm, 3.000 K



578390307





Gibt Licht nach oben und unten •  
up and down lighting • point lumineux en haut et en bas •  
lichtpunt boven en onder • luz de arriba y abajo • luce su e giù •  
sus și în jos lumina • ylös ja alas valoa • w górę iw dół światło • yukarı ve aşağı ışık





## Columbus

Nickel matt • nickel mat •  
 nickel mat • nikkell mat • níquel mate • nichel opaco •  
 nichel mat • harjattu teräs • nikiel mat • mat nikel



↑ 168 cm, ↗ 130 cm, Ø 35 cm  
 incl. 4 x SMD, 4,5 W  
 4 x 430 lm, 3.000 K



478490407



↔ 110 cm, ↑ 95 - 160 cm  
 incl. 6 x SMD, 4,5 W  
 6 x 430 lm, 3.000 K



378490607



↔ 80 x 34 cm, ↑ 14 cm  
 incl. 8 x SMD, 4,5 W  
 8 x 430 lm, 3.000 K



678410807  
 C 678410807 Smart control



↔ 17 cm, ↑ 48 cm, ↗ 36 cm  
 incl. 2 x SMD, 4,5 W  
 2 x 430 lm, 3.000 K



578490207



↑ 38 cm, ↗ 17 cm, Ø 16 cm  
 incl. 2 x SMD, 4,5 W  
 2 x 430 lm, 3.000 K



278490207





↔ 100 x 10 cm, ↓ 120 cm  
incl. 5 x SMD, 4,5 W  
5 x 400 lm, 3.000 K

↔ 30 cm, ↓ 10 cm, ↗ 8 cm  
incl. 2 x SMD, 4,5 W  
2 x 400 lm, 3.000 K

↔ 12 x 18 cm, ↓ 46 cm  
incl. 3 x SMD, 4,5 W  
3 x 400 lm, 3.000 K

↔ 16 x 30 cm, ↓ 106,5 cm  
incl. 5 x SMD, 3,2 W  
5 x 300 lm, 3.000 K

↔ 49 x 18 cm, ↓ 180 cm, ↗ 45 cm  
incl. 5 x SMD, 4,5 W  
5 x 400 lm, 3.000 K

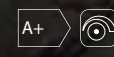

376910506

276970206

576910306

476990506

476910506



# Teano

chrom, Glas satiniert • chrome, satinated glass •  
chrome, verre satiné • chroom, gesatineerd glas • cromo, vidrio satinado • cromo, vetro satinato •  
crom, sticla satinata • kromi, satinoitu lasi • chrom, szkło satynowe • krom, satin cam

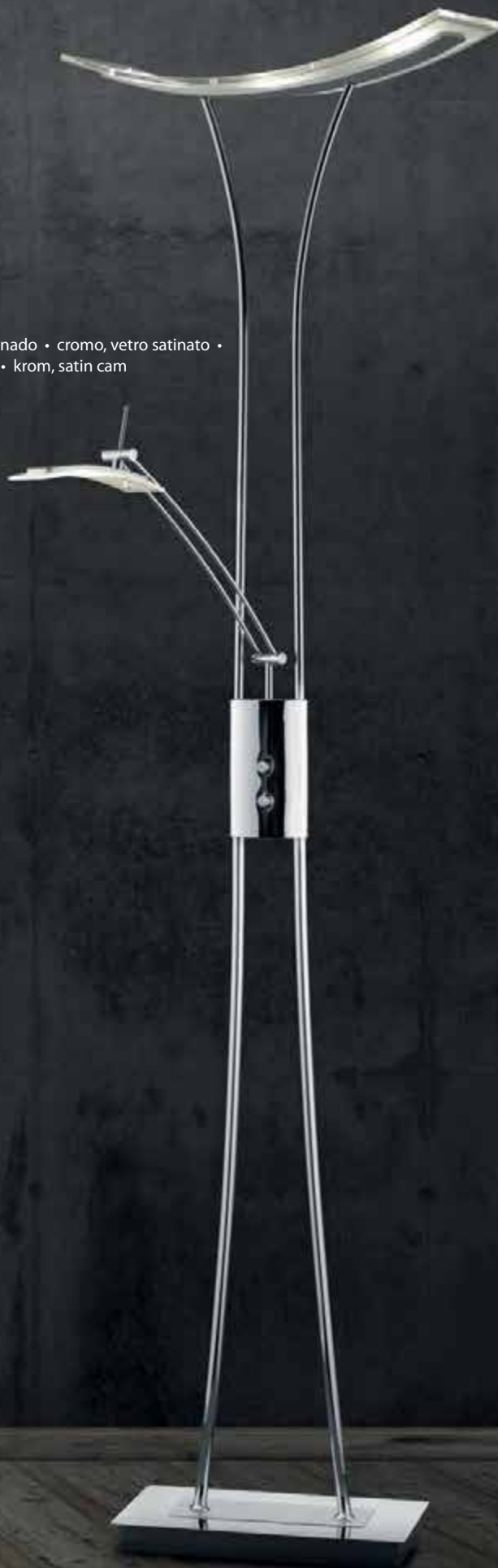



# Portofino

chrom, Acryl • chrome, acryl •  
 chrome, acryl • chroom, acryl • cromo, acrílico • cromo, acrílico •  
 crom, acrilic • kromi, akryyli • chrom, akryl • krom, akrilik



↔ 11 cm, ↑ 83 cm, ∠ 28 cm  
 incl. 2 x SMD, 8 W  
 2 x 800 lm, 3.000 K



276370206



↑ 85 cm, Ø 16 cm  
 incl. 2 x SMD, 8 W  
 2 x 800 lm, 3.000 K



576390206



↑ 155 cm, Ø 21 cm  
 incl. 2 x SMD, 12 W  
 2 x 1.200 lm, 3.000 K

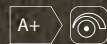

476310206

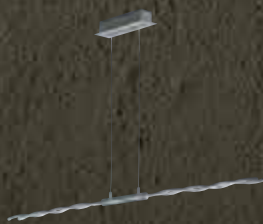

↔ 149 cm, ↑ 150 cm  
 incl. 4 x SMD, 7 W  
 4 x 700 lm, 3.000 K

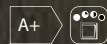

376310406

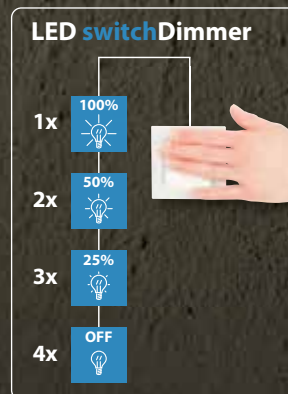



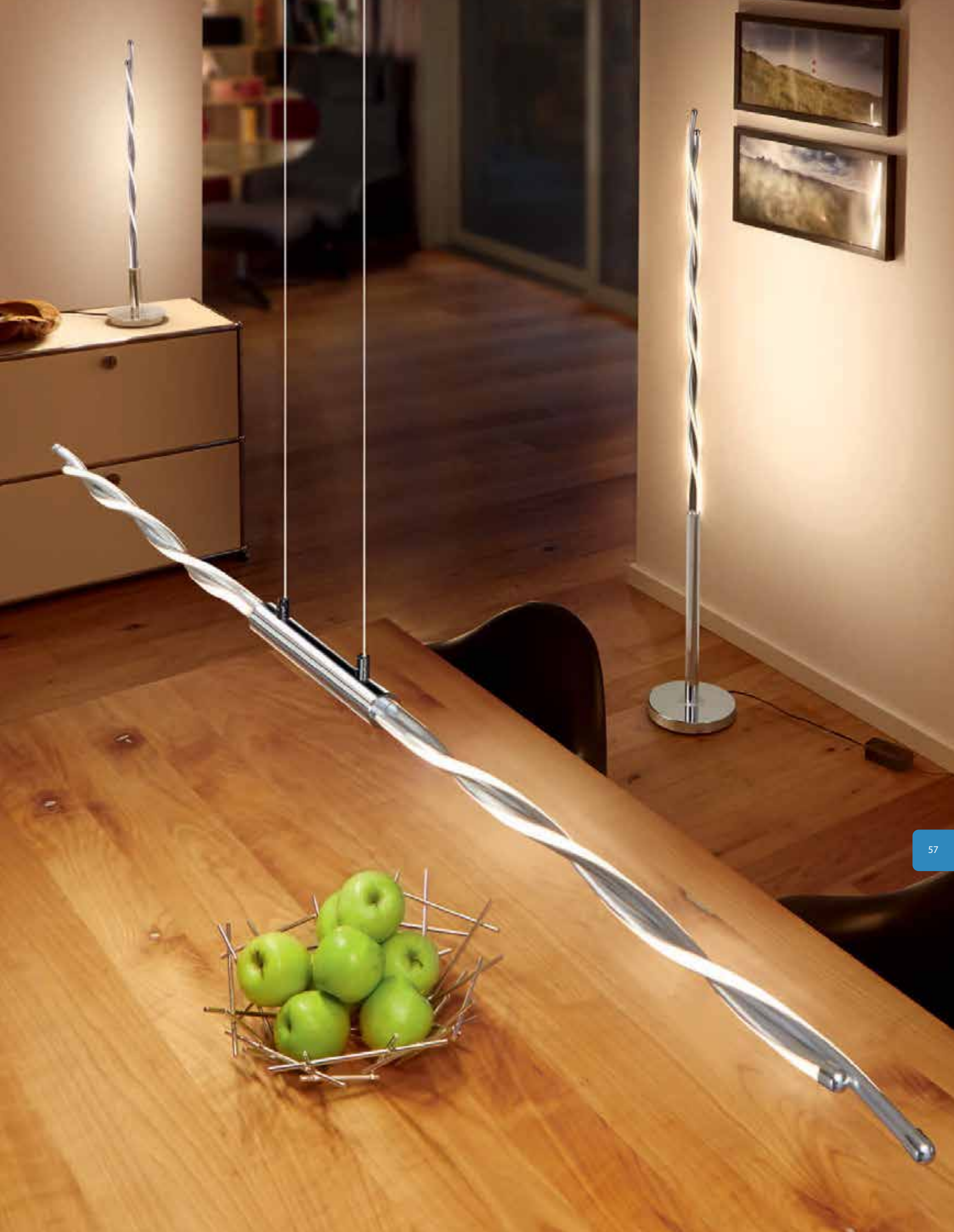

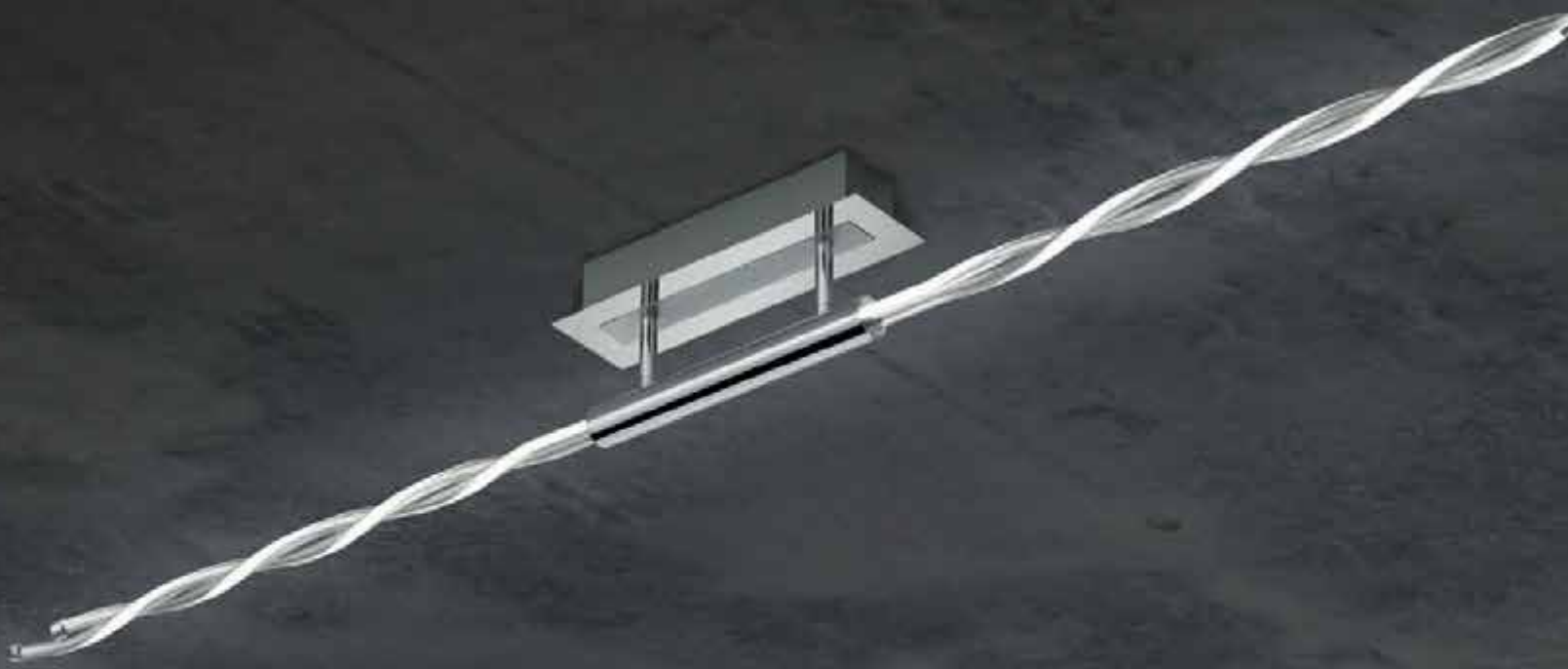

# Portofino

chrom, Acryl • chrome, acryl •  
 chrome, acryl • chroom, acryl • cromo, acrílico • cromo, acrilico •  
 crom, acrilic • kromi, akryyli • chrom, akryl • krom, akrilik



↔ 149 cm, ↑ 14 cm  
 incl. 4 x SMD, 7 W  
 4 x 700 lm, 3.000 K



676310206



↑ 23 cm, Ø 85 cm  
 incl. 4 x SMD, 4,1 W, 4 x 440 lm  
 incl. 4 x SMD, 2,8 W, 4 x 280 lm  
 3.000 K



676310806

## LED switch Dimmer

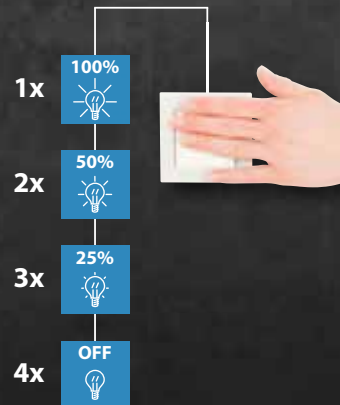

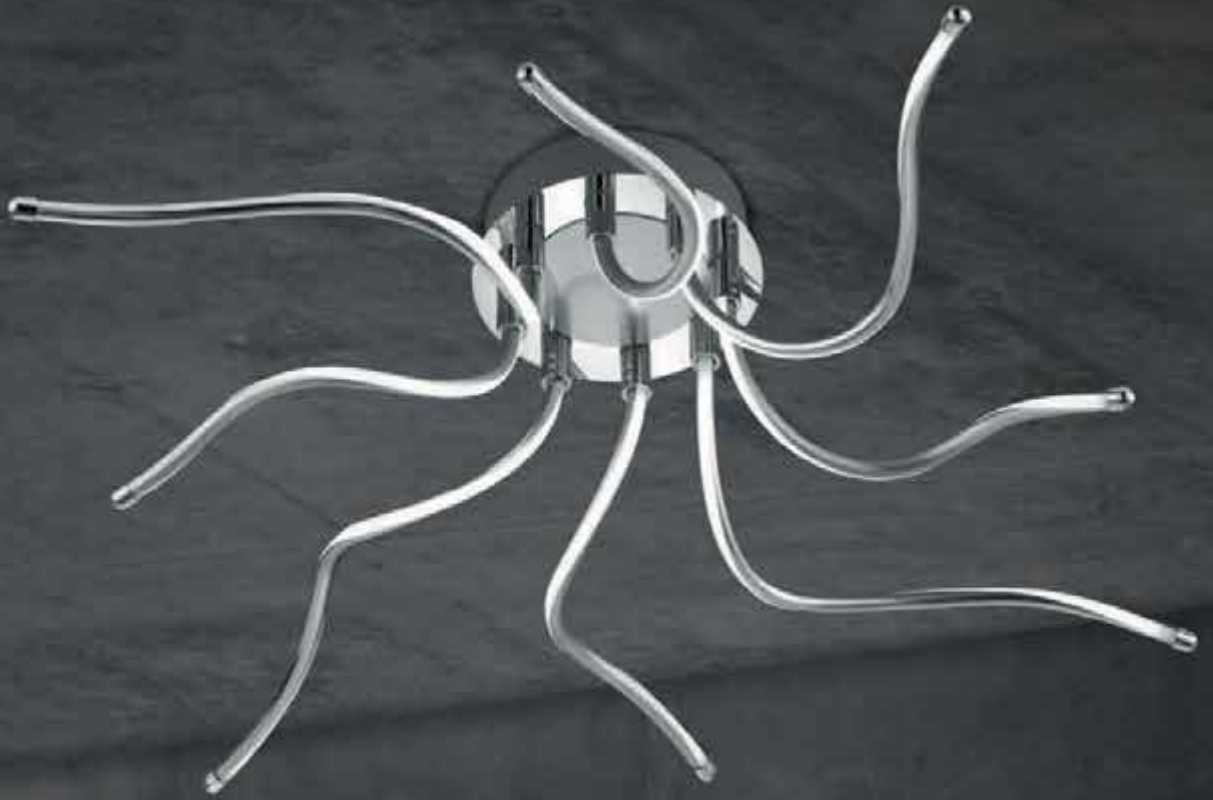





↔ 103 cm, ↑ 80 - 130 cm  
incl. SMD, 14,5 W  
1.300 lm, 3.000 K



372910106

C 372910106 Smart control



↔ 103 cm, ↓ 27 cm  
incl. SMD, 14,5 W  
1.300 lm, 3.000 K



672910106

C 672910106 Smart control



↓ 162 cm, Ø 25 cm  
incl. SMD, 14,5 W  
1.300 lm, 3.000 K



472910106



↓ 63 cm, Ø 20 cm  
incl. SMD, 14,5 W  
1.300 lm, 3.000 K



572910106



## Sidney

chrom, Acryl • chrome, acryl •  
chrome, acryl • chroom, acryl • cromo, acrilico • cromo, acrilico •  
crom, acrylic • kromi, akryyli • chrom, akryl • krom, akrilik





# Clinton

chrom, Acryl • chrome, acryl •  
 chrome, acryl • chroom, acryl • cromo, acrílico • cromo, acrílico •  
 crom, acrílic • kromi, akryyli • chrom, akryl • krom, akrilik



↔ 12 x 12 cm, ↗ 8,5 cm  
 incl. 1 x SMD, 4,5 W  
 430 lm, 3.000 K

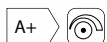

275290106



↔ 30 x 11 cm, ↗ 8,5 cm  
 incl. 2 x SMD, 4,5 W  
 2 x 430 lm, 3.000 K

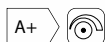

275290206



↔ 50 x 11 cm, ↗ 8,5 cm  
 incl. 3 x SMD, 4,5 W  
 3 x 430 lm, 3.000 K

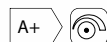

275290306



↔ 28 x 28 cm, ↓ 9 cm  
 incl. 4 x SMD, 4,5 W  
 4 x 430 lm, 3.000 K

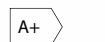

675210406



↔ 32 x 32 cm, ↓ 9 cm  
 incl. 5 x SMD, 4,5 W  
 5 x 430 lm, 3.000 K



675210506  
 C 675210506 Smart Control



↔ 90,5 cm, ↑ 95 - 150 cm  
incl. 5 x SMD, 4,5 W  
5 x 430 lm, 3.000 K



375210506  
C 375210506 Smart Control







# Modena

Nickel matt • matt nickel •  
 nickel mat • nikkel mat • níquel mate • nichel opaco •  
 nichel mat • harjattu teräs • nikiel mat • mat nikel

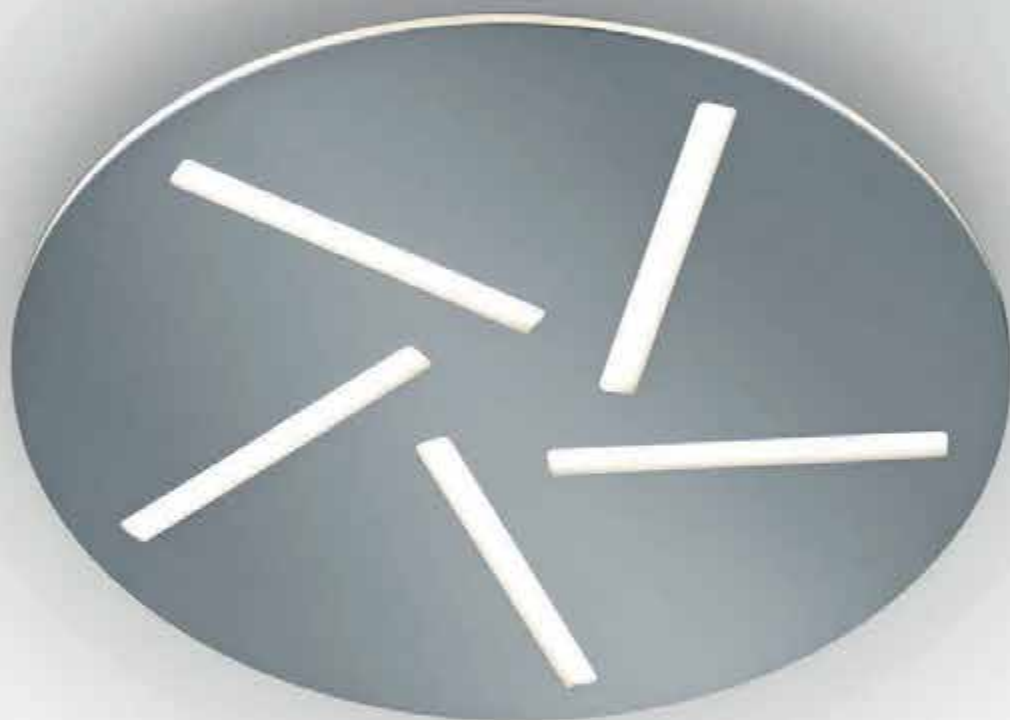

## LED switchDimmer



↔ 90 x 6 cm, ↓ 95 - 160 cm  
 incl. SMD, 18 W  
 1.800 lm, 3.000 K



376810107  
 C 376810107 Smart control



Ø 39,5 cm, ↓ 4,5 cm  
 incl. 5 x SMD, 5 W  
 5 x 550 lm, 3.000 K

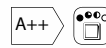

676810507



Ø 29,5 cm, ↓ 4,5 cm  
 incl. 3 x SMD, 5 W  
 3 x 550 lm, 3.000 K



676810307



↓ 30 cm, Ø 18 cm  
incl. SMD, 7 W  
600 lm, 3.000 K



579410705



↓ 50 cm, Ø 29 cm  
incl. SMD, 11 W  
850 lm, 3.000 K



579411105



↓ 180 cm, Ø 38 cm  
incl. SMD, 18 W  
1.800 lm, 3.000 K



479411805



↔ 80 x 35 cm, ↓ 120 cm  
incl. SMD, 27 W  
2.700 lm, 3.000 K



379412705



## Toronto

Aluminium gebürstet, Acryl • brushed aluminium, acryl •  
aluminium balayé, acryl • geborsteld aluminium, acryl • aluminio pulido, acrílico • alluminio spazzolato, acrilico •  
aluminiumu lucios, acrilic • harjattu alumiini, akryyli • aluminiumu szczotkowane, akryl • alüminyum, akrilik





↑ 35 cm, Ø 38 cm  
incl. SMD, 18 W  
1.800 lm, 3.000 K

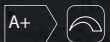

679411805



↑ 75 - 130 cm, Ø 38 cm  
incl. SMD, 18 W  
1.800 lm, 3.000 K



379411805



↙ 6,5 cm, Ø 18 cm  
incl. SMD, 7 W  
630 lm, 3.000 K



221770105





## Toronto

Aluminium gebürstet, Acryl • brushed aluminium, acryl •  
aluminium balayé, acryl • geborsteld aluminium, acryl • aluminio pulido, acrílico • alluminio spazzolato, acrílico •  
aluminiumu lucios, acrílic • harjattu alumiini, akryyli • aluminium szczotkowane, akryl • alüminyum, akrilik





↔ 80 x 16 cm, ↑ 150 cm  
incl. 10 x SMD, 3,2 W  
10 x 300 lm, 3.000 K

↔ 35 x 35 cm, ↑ 8,5 cm  
incl. 8 SMD, 3,2 W  
8 x 300 lm, 3.000 K

↔ 45 x 45 cm, ↑ 8,5 cm  
incl. 12 SMD, 3,2 W  
12 x 300 lm, 3.000 K

↔ 12 x 12 cm, ↗ 4 cm  
incl. 1 x SMD, 3,2 W  
300 lm, 3.000 K

↔ 25 x 9,5 cm, ↗ 4 cm  
incl. 2 x SMD, 3,2 W  
2 x 300 lm, 3.000 K

↔ 40 x 9,5 cm, ↗ 4 cm  
incl. 3 x SMD, 3,2 W  
3 x 300 lm, 3.000 K



373111006

673110806

673111206

273190106

273190206

273190306

C 373111006 Smart control

C 673110806 Smart control

C 673111206 Smart control



## Basel

Aluminium gebürstet, Acryl • brushed aluminium, acryl •  
aluminium balayé, acryl • geborsteld aluminium, acryl • aluminio pulido, acrílico • alluminio spazzolato, acrílico •  
aluminiumu lucios, acrílic • harjattu alumiini, akryyli • aluminium szczotkowane, akryl • alüminyum, akrilik





## Silas

Aluminium gebürstet • brushed aluminium •  
aluminium balayé • geborsteld aluminium • aluminio pulido •  
alluminio spazzolato • aluminiu lucios • harjattu alumini •  
aluminium szczotkowane • alüminyum

LED



↔ 115 x 8 cm, ↑ 120 cm  
incl. SMD, 45 W  
4.500 lm, 3.000 K



372294505



↔ 80 x 8 cm, ↑ 6 cm  
incl. SMD, 24 W  
2.400 lm, 3.000 K



672212405  
C 672212405 Smart control







# Denver

Nickel matt, Acryl • nickel mat, acryl •  
 nickel mat, acryl • nikkell mat, acryl • níquel mate, acrílico • nichel opaco, acrílico •  
 nichel mat, acrílico • harjattu teräs, akryyli • nikiel mat, akryl • mat nikel, akrilik



↔ 93 x 8 cm, ↑ 62 - 110 cm  
 incl. 2 x SMD, 18 W  
 2 x 1.800 lm, 3.000 K



**379613607**

C 379613607 Smart control



↔ 110 x 9 cm, ↑ 95 - 160 cm  
 incl. 1 x SMD, 29 W  
 2.800 lm, 3.000 K

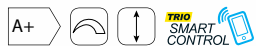

**379610107**

C 379610107 Smart control



↔ 18 x 18 cm, ↑ 56 cm  
 incl. 2 x SMD, 3 W  
 2 x 310 lm, 3.000 K



**579610207**



↔ 24 x 24 cm, ↑ 130 cm  
 incl. 2 x SMD, 4,3 W  
 2 x 460 lm, 3.000 K



**479610207**





# Denver

Nickel matt, Acryl • nickel mat, acryl •  
nickel mat, acryl • nikkell mat, acryl • níquel mate, acrílico • nichel opaco, acrílico •  
nichel mat, acrilic • harjattu teräs, akryyli • nikiel mat, akryl • mat nikel, akrilik



↔ 13 x 13 cm, ↗ 13 cm  
incl. 2 x SMD, 4,3 W  
2 x 460 lm, 3.000 K



279670207



↔ 20 x 55 cm, ↓ 5,5 cm  
incl. 2 x SMD, 10 W  
2 x 900 lm, 3.000 K



279690207  
C 279690207 Smart control



↔ 30 x 55 cm, ↓ 5,5 cm  
incl. 3 x SMD, 10 W  
3 x 900 lm, 3.000 K



679612807  
C 679612807 Smart control



↔ 40 x 9 cm, ↓ 15 cm  
incl. 2 x SMD, 4,3 W  
2 x 460 lm, 3.000 K



879610207



↔ 58 x 9 cm, ↓ 15 cm  
incl. 3 x SMD, 4,3 W  
3 x 460 lm, 3.000 K

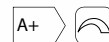

879610307



↔ 100 x 9 cm, ↓ 21,5 cm  
incl. 4 x SMD, 4,3 W  
4 x 460 lm, 3.000 K



879610407





# Duellant

chrom / Nickel matt, Acryl • chrome / nickel mat, acryl •  
chrome / nickel mat, acryl • chroom / nikkell mat, acryl • cromo / níquel mate, acrílico •  
cromo / nichel opaco, acrílico • crom / nichel mat, acrilic • kromi / harjattu teräs, akryyli •  
chrom / nikiel mat, akryl • krom / mat nikel, akrilik

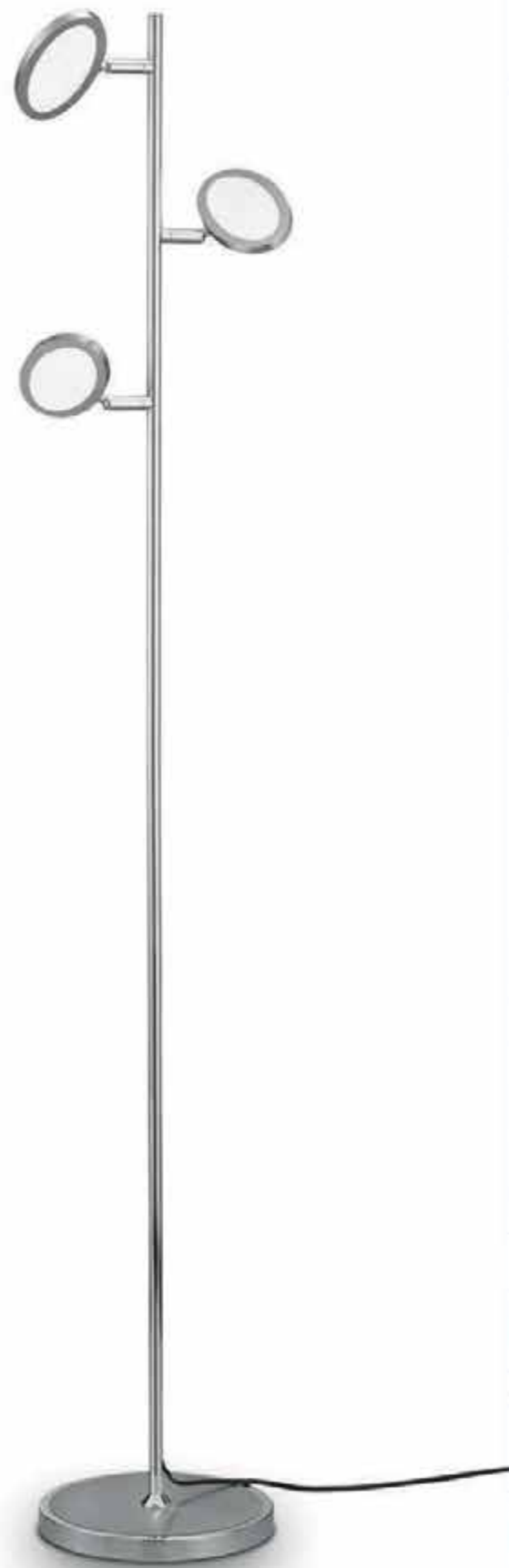

↔ 90 cm, ↑ 95 - 150 cm  
incl. 5 x SMD, 4,3 W  
5 x 400 lm, 3.000 K



372010506



↑ 140 cm, Ø 22 cm  
incl. 3 x SMD, 4,3 W  
3 x 400 lm, 3.000 K



472010306



↑ 43 cm, Ø 22 cm  
incl. 2 x SMD, 4,3 W  
2 x 400 lm, 3.000 K



572010206





↔ 13,5 x 8,5 cm, ↗ 12 cm  
incl. SMD, 4,3 W  
400 lm, 3.000 K



872070106



↔ 36,5 cm, ↓ 15 cm  
incl. 2 x SMD, 4,3 W  
2 x 400 lm, 3.000 K



872010206



↔ 52,5 cm, ↓ 15 cm  
incl. 3 x SMD, 4,3 W  
3 x 400 lm, 3.000 K



872010306



↔ 85 cm, ↓ 24 cm  
incl. 4 x SMD, 4,3 W  
4 x 400 lm, 3.000 K



872010406



↔ 180 cm, ↓ 17 cm  
incl. 6 x SMD, 4,3 W  
6 x 400 lm, 3.000 K



872010606



↔ 65 x 46 cm, ↓ 24 cm  
incl. 5 x SMD, 4,3 W  
5 x 400 lm, 3.000 K



672010506





## Duellant

chrom / Nickel matt, Acryl • chrome / nickel mat, acryl •  
chrome / nickel mat, acryl • chrom / nikkel mat, acryl • cromo / níquel mate, acrílico •  
cromo / nichel opaco, acrílico • crom / nichel mat, acrílic • kromi / harjattu teräs, akryyli •  
chrom / nikiel mat, akryl • krom / mat nikel, akrilik



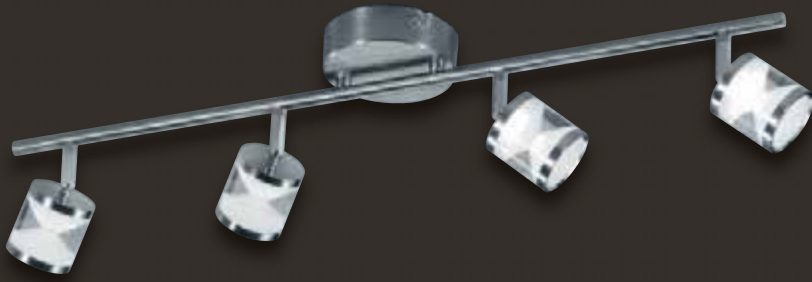

08

07



## Cassini

Nickel matt oder Messing matt, Acryl • nickel mat or brass mat, acryl •  
 nickel mat ou laiton mat, acryl • nikkell mat of messing mat, acryl • níquel mate o  
 bronze mate, acrílico • nichel opaco o ottone satinato, acrílico • nichel mat sau  
 bronz mat, acrílic • harjattu teräs tai mattamessinki, akryyli • nikiel mat lub mosiądz  
 mat, akryl • mat nikel veya mat piring, akrilik



Ø 9 cm, ↑ 13 cm  
 incl. 1 x SMD, 4,5 W  
 400 lm, 3.000 K



877170107  
 877170108



↔ 36 cm, ↑ 18 cm  
 incl. 2 x SMD, 4,5 W  
 2 x 400 lm, 3.000 K



877110207  
 877110208



↔ 52 cm, ↑ 18 cm  
 incl. 3 x SMD, 4,5 W  
 3 x 400 lm, 3.000 K



877110307  
 877110308



↔ 70 cm, ↑ 18 cm  
 incl. 4 x SMD, 4,5 W  
 4 x 400 lm, 3.000 K



877110407  
 877110408



↔ 162 cm, ↑ 18,5 cm  
 incl. 6 x SMD, 4,5 W  
 6 x 400 lm, 3.000 K



877110607  
 877110608



↑ 35 cm, Ø 12 cm  
 incl. 1 x SMD, 4,5 W  
 400 lm, 3.000 K



577110107  
 577110108



↑ 140 cm, Ø 20 cm  
incl. 2 x SMD, 4,5 W  
2 x 400 lm, 3.000 K



477110207  
477110208

↔ 70 cm, ↑ 95 - 160 cm  
incl. 4 x SMD, 4,5 W  
4 x 400 lm, 3.000 K



377110407  
377110408



**07** Nickel matt • matt nickel  
**08** Messing matt • matt brass



## Figaro

Nickel matt • matt nickel •  
 nickel mat • nikkell mat • níquel mate • nichel opaco •  
 nichel mat • harjattu teräs • nikiel mat • mat nikel



↔ 40 x 40 cm, ↓ 22,5 cm  
 incl. 4 x SMD, 4,5 W  
 4 x 380 lm, 3.000 K



678210407



↔ 90 x 12,5 cm, ↓ 95 - 160 cm  
 incl. 3 x SMD, 4,5 W  
 3 x 380 lm, 3.000 K



378210307



↔ 66 cm, ↓ 150 cm  
 incl. 4 x SMD, 4,5 W  
 4 x 380 lm, 3.000 K



378210407



↓ 150 cm, Ø 25 cm  
 incl. SMD, 4,5 W  
 380 lm, 3.000 K



378210107



↓ 42 cm, Ø 12 cm  
 incl. SMD, 4,5 W  
 380 lm, 3.000 K



578210107







↑ 50 cm, ↗ 13 cm  
incl. 2 x SMD, 5 W  
2 x 500 lm, 3.000 K



277690206



↔ 185 cm, ↑ 120 cm  
incl. 1 x SMD, 24 W  
2.200 lm, 3.000 K



377610106



Ø 95,5 cm, ↑ 15 cm  
incl. 6 x SMD, 5 W  
6 x 500 lm, 3.000 K



677610606  
C677610606 Smart Control



## Sandro

chrom, Acryl • chrome, acryl •  
chrome, acryl • chroom, acryl • cromo, acrílico •  
cromo, acrílico • crom, acrílic • kromi, akryyli •  
chrom, akryl • krom, akrilik



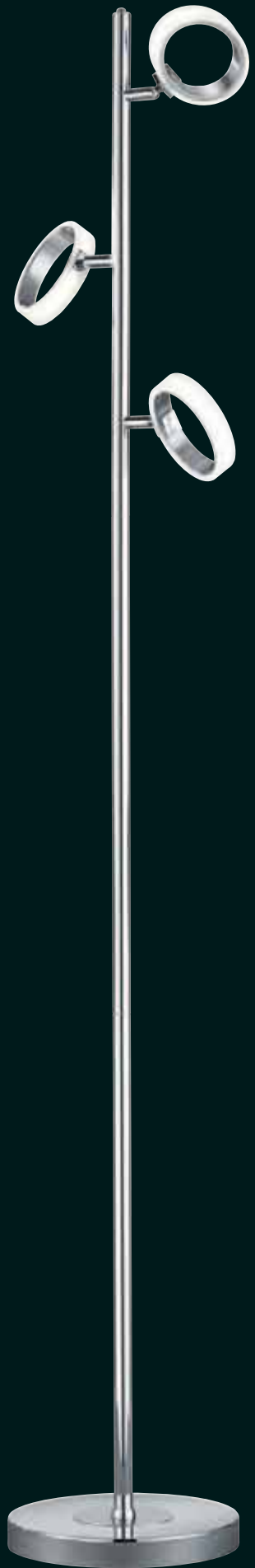
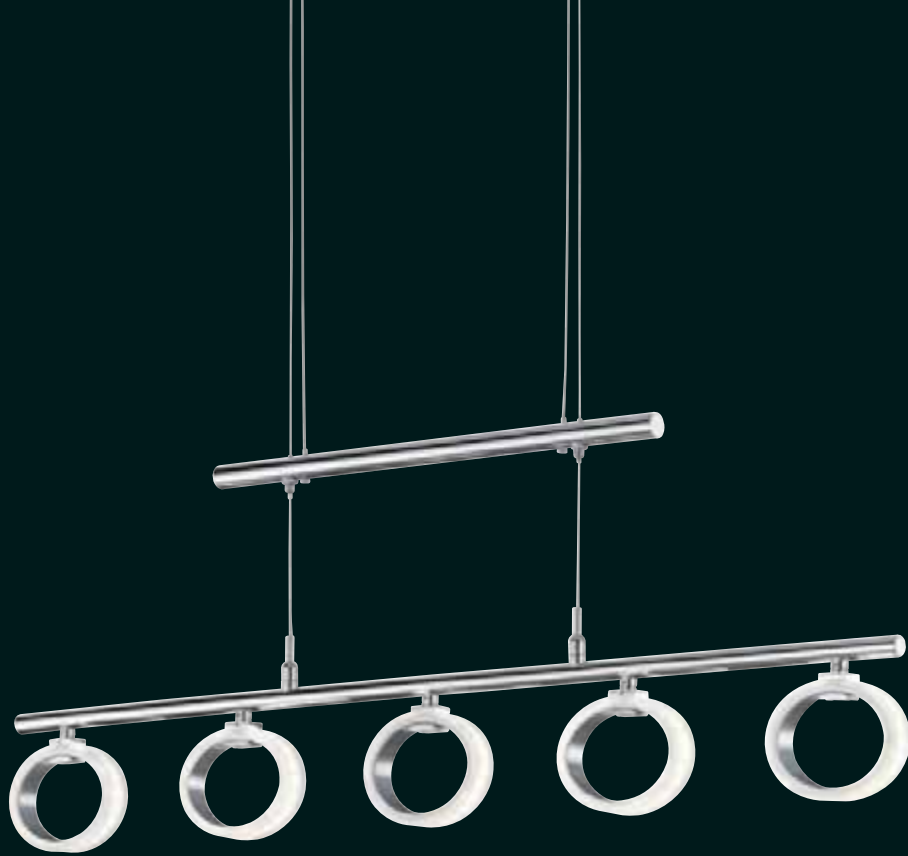

↔ 14 x 11 cm, ↑ 12 cm  
incl. 1 x SMD, 5 W  
450 lm, 3.000 K



574310106



↑ 150 cm, Ø 23 cm  
incl. 3 x SMD, 5 W  
3 x 450 lm, 3.000 K



474310306



↔ 48 x 40 cm, ↑ 38 cm  
incl. 1 x SMD, 24 W  
2.160 lm, 3.000 K



674312406

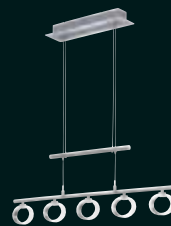

↔ 85 cm, ↑ 95 - 160 cm  
incl. 5 x SMD, 5 W  
5 x 450 lm, 3.000 K



374310506  
C 374310506





## Corland

chrom, Aluminium gebürstet • chrome, brushed aluminium •  
chrome, aluminium balayé • chrom, geborsteld aluminium •  
cromo, aluminio pulido • cromo, alluminio spazzolato • crom,  
aluminium lucios • kromi, harjattu alumiini • chrom, aluminium  
szczotkowane • krom, alüminyum



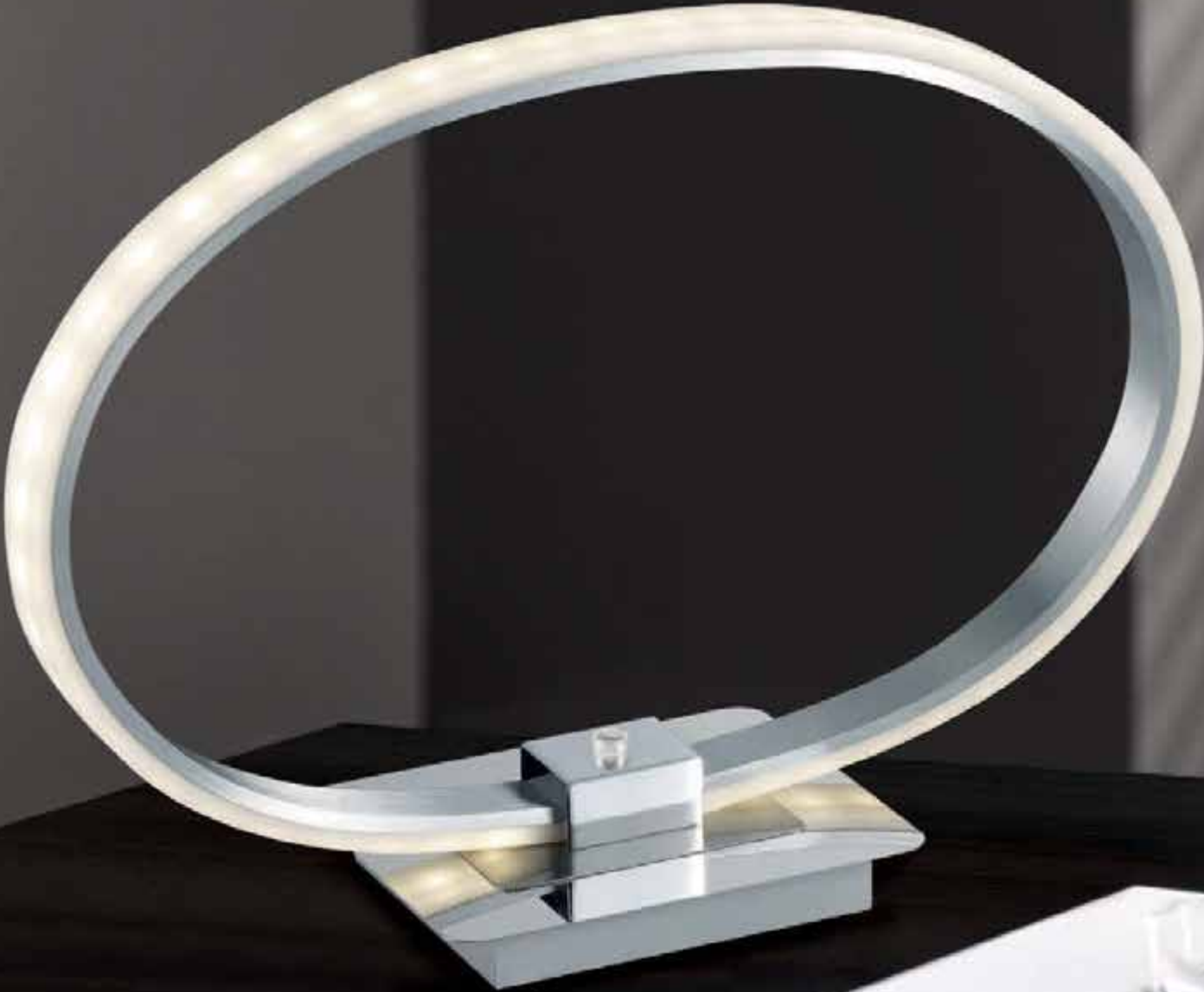



## Corland

chrom, Aluminium gebürstet • chrome, brushed aluminium •  
 chrome, aluminium balayé • chroom, geborsteld aluminium •  
 cromo, aluminio pulido • cromo, alluminio spazzolato • crom,  
 aluminu lucios • kromi, harjattu alumiini • chrom, aluminium  
 szczotkowane • krom, alüminyum



↑ 14 x 11 cm, ↗ 15 cm  
 incl. 1 x SMD, 5 W  
 450 lm, 3.000 K



874370106



↔ 30 x 11 cm, ↓ 14 cm  
 incl. 2 x SMD, 5 W  
 2 x 450 lm, 3.000 K



874310206



↔ 45 x 11 cm, ↓ 14 cm  
 incl. 3 x SMD, 5 W  
 3 x 450 lm, 3.000 K



874310306



↔ 81 x 11 cm, ↓ 14 cm  
 incl. 4 x SMD, 5 W  
 4 x 450 lm, 3.000 K

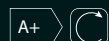

874310406



↔ 150 x 11 cm, ↓ 14 cm  
 incl. 6 x SMD, 5 W  
 6 x 450 lm, 3.000 K



874310606



↔ 33 x 11 cm, ↓ 24 cm  
 incl. 1 x SMD, 10 W  
 900 lm, 3.000 K



574391006



## Marius

Aluminium gebürstet, chrom • brushed aluminium, chrome • aluminium balayé, chrome • geborsteld aluminium, chroom • aluminio pulido, cromo • alluminio spazzolato, cromo • aluminiu lucios, crom • harjattu alumiini, kromi • aluminium szczotkowane, chrom • alüminyum, krom



↑ 42 x 10 cm, ↗ 9 cm  
incl. 1 x SMD, 10 W  
900 lm, 3.000 K



274191005



↑ 55 cm, ↔ 10 x 15 cm  
incl. 1 x SMD, 10 W  
900 lm, 3.000 K



574191005



↑ 132 cm, ↔ 15 x 22 cm  
incl. 1 x SMD, 25 W  
2.300 lm, 3.000 K



474112505



↔ 100 x 3,5 cm, ↑ 150 cm  
incl. 1 x SMD, 25 W  
2.300 lm, 3.000 K



374112505  
C 374112505



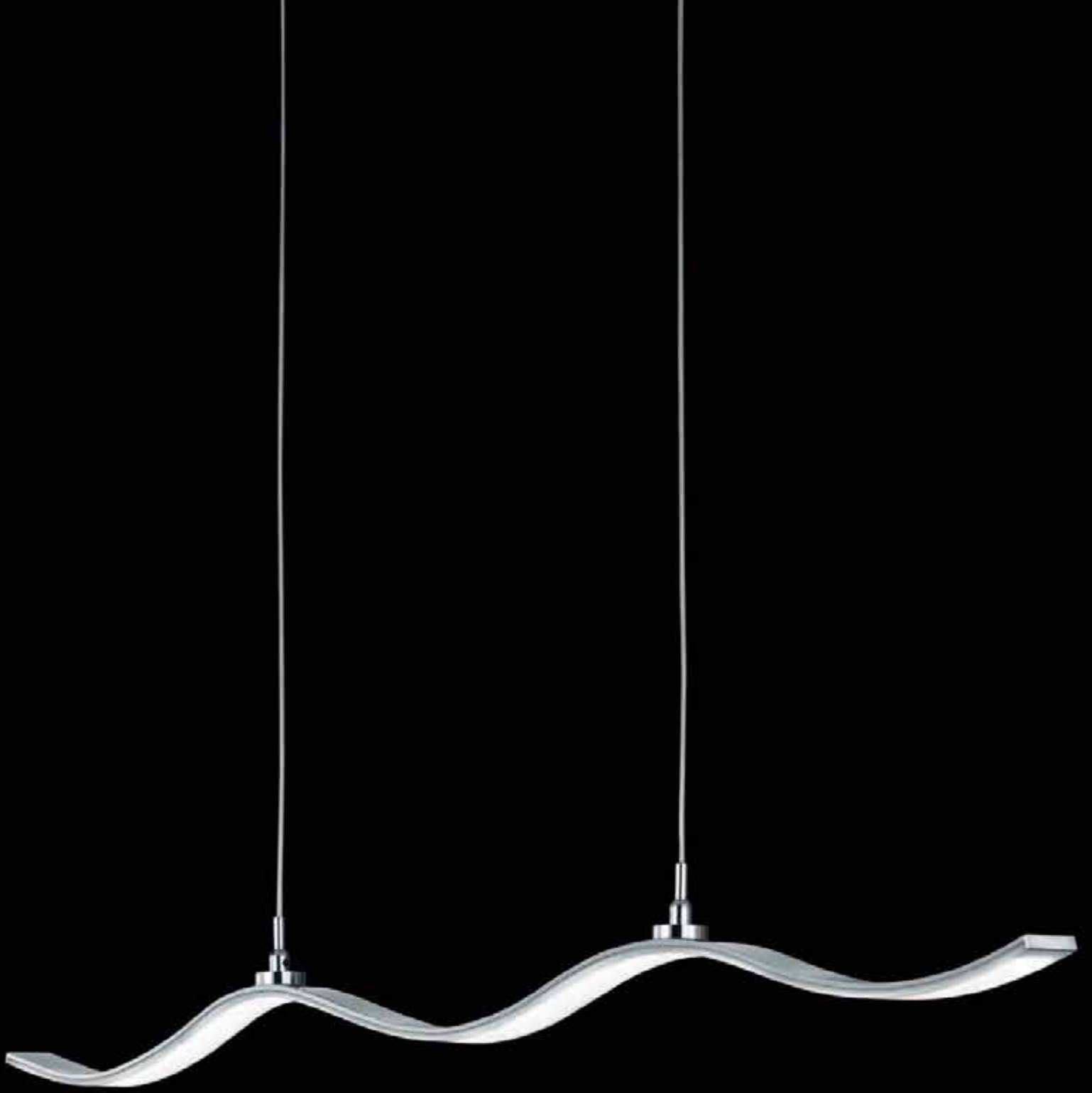



↔ 100 x 10 cm, ↑ 8,5 cm  
incl. 2 x SMD, 11 W  
2 x 1.100 lm, 3.000 K



871810205



↔ 180 x 10 cm, ↑ 12 cm  
incl. 4 x SMD, 11 W  
4 x 1.100 lm, 3.000 K



871810405



Ø 60 cm, ↑ 14 cm  
incl. 3 x SMD, 6 W  
3 x 640 lm, 3.000 K



671810305



↔ 105 cm, ↑ 95 - 160 cm  
incl. 3 x SMD, 11 W  
3 x 1.100 lm, 3.000 K



371810305



## Highway

Aluminium gebürstet • brushed aluminium •  
aluminium balayé • geborsteld aluminium • aluminio pulido •  
alluminio spazzolato • aluminiu lucios • harjattu alumiini •  
aluminium szczotkowane • alüminyum





## Opium

Nickel matt, chrom, Acryl • nickel mat, chrome, acryl •  
 nickel mat, chrome, acryl • nikkell mat, chroom, acryl •  
 níquel mate, cromo, acrílico • nichel opaco, cromo, acrílico •  
 nichel mat, crom, acrílic • harjattu teräs, kromi, akryyli •  
 nikiel mat, chrom, akryl • mat nikel, krom, akrilik



↓ 35 cm, ↔ 14 x 14 cm  
 incl. 1 x SMD, 4,5 W  
 430 lm, 3.000 K



570610107



↓ 150 cm  
 incl. 3 x SMD, 4,5 W  
 3 x 430 lm, 3.000 K



470690307



↔ 80 cm, ↓ 95 - 160 cm  
 incl. 4 x SMD, 4,5 W  
 4 x 430 lm, 3.000 K

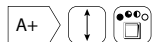

370610407

### LED switchDimmer

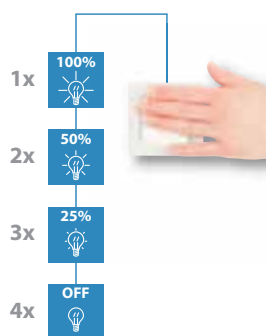



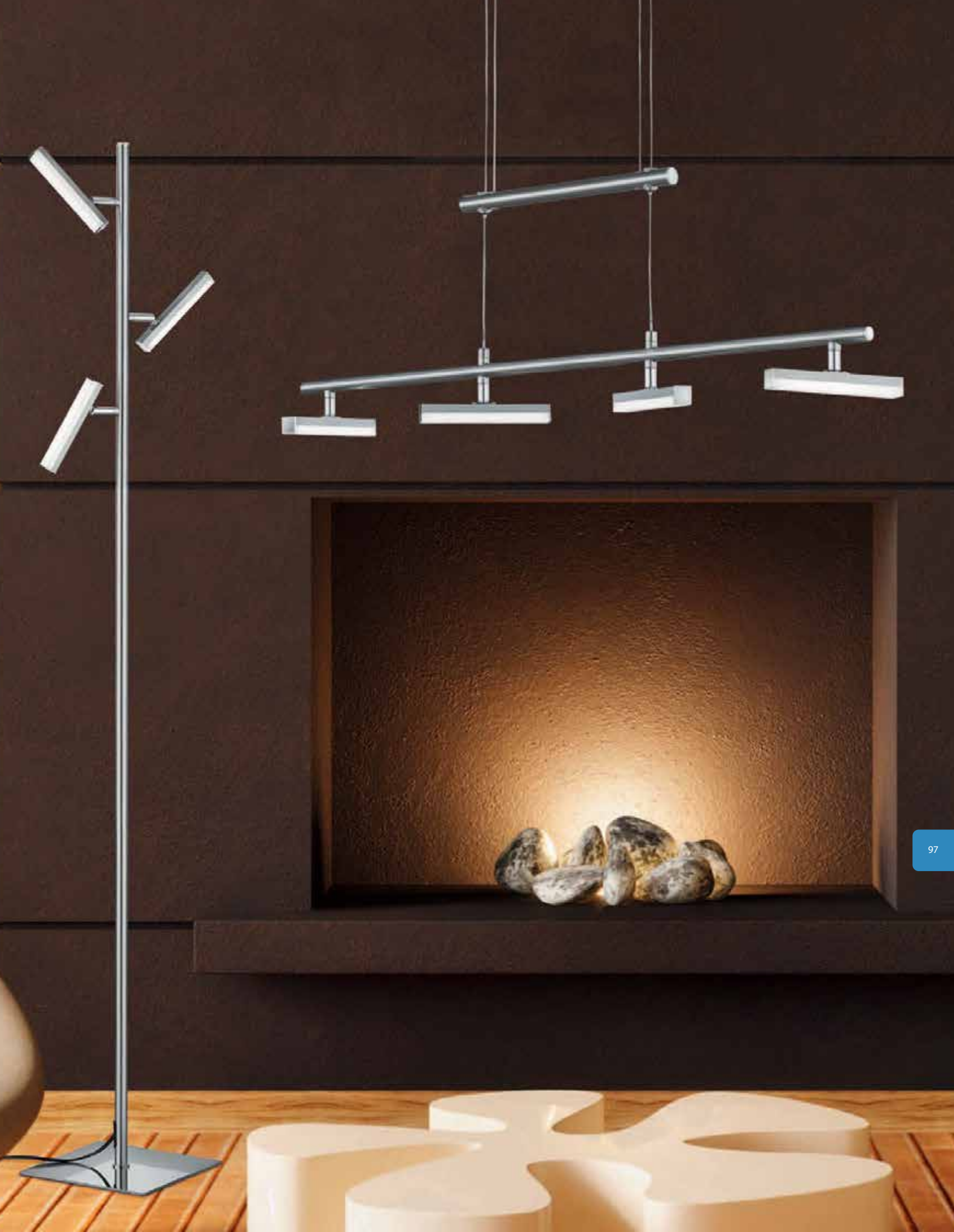



## Opium

Nickel matt, chrom, Acryl • nickel mat, chrome, acryl •  
nickel mat, chrome, acryl • nikkell mat, chrom, acryl •  
níquel mate, cromo, acrílico • nichel opaco, cromo, acrílico •  
nichel mat, crom, acrilic • harjattu teräs, kromi, akryyli •  
nikiel mat, chrom, akryl • mat nikel, krom, akrilik



↑ 7 x 14,5 cm, ↗ 16 cm  
incl. 1 x SMD, 4,5 W  
430 lm, 3.000 K

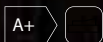

870670107



↔ 36 x 7 cm, ↓ 20 cm  
incl. 2 x SMD, 4,5 W  
2 x 430 lm, 3.000 K



870610207



↔ 51 x 7 cm, ↓ 20 cm  
incl. 3 x SMD, 4,5 W  
3 x 430 lm, 3.000 K



870610307



↔ 75 x 7 cm, ↓ 20 cm  
incl. 4 x SMD, 4,5 W  
4 x 430 lm, 3.000 K



870610407



↔ 25 x 25 cm, ↓ 15 cm  
incl. 4 x SMD, 4,5 W  
4 x 430 lm, 3.000 K



670610407



↔ 40 x 27,5 cm, ↓ 15 cm  
incl. 6 x SMD, 4,5 W  
6 x 430 lm, 3.000 K

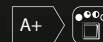

670610607

# LED switchDimmer

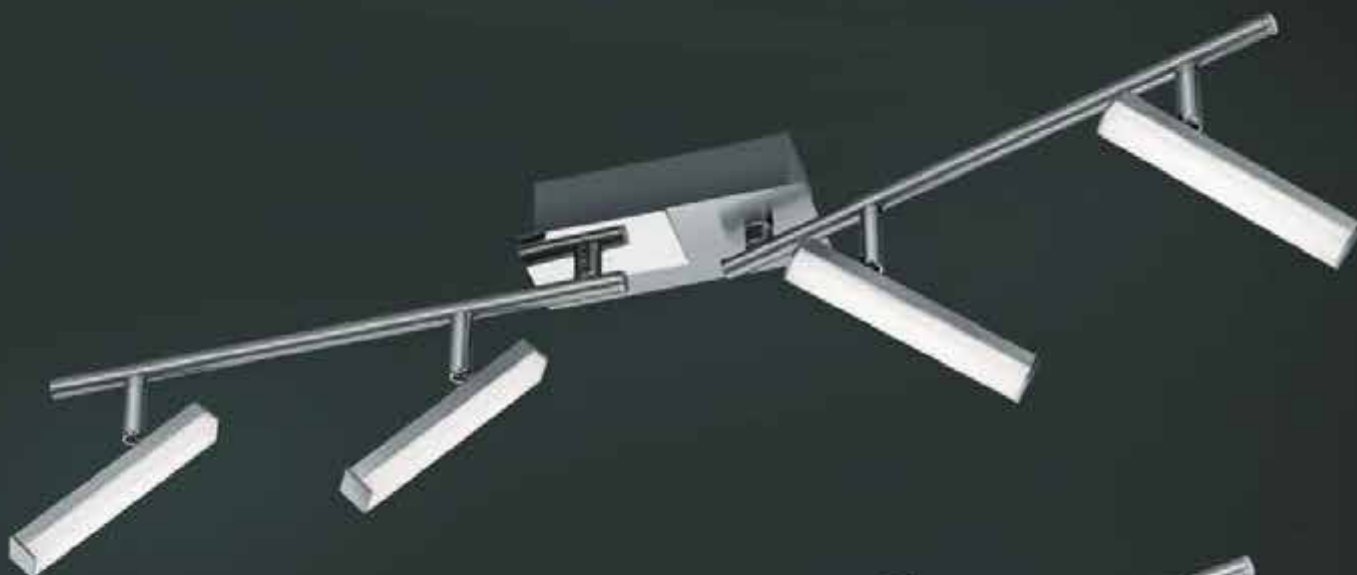
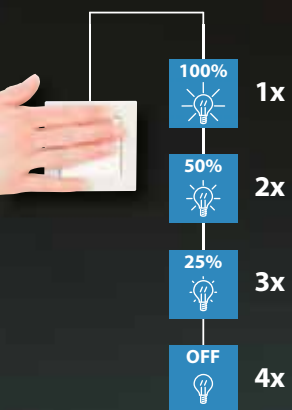



## Pilatus

chrom, Acryl • chrome, acryl •  
 chrome, acryl • chrom, acryl • cromo, acrílico •  
 cromo, acrílico • crom, acrílic • kromi, akryyli •  
 chrom, akryl • krom, akrilik

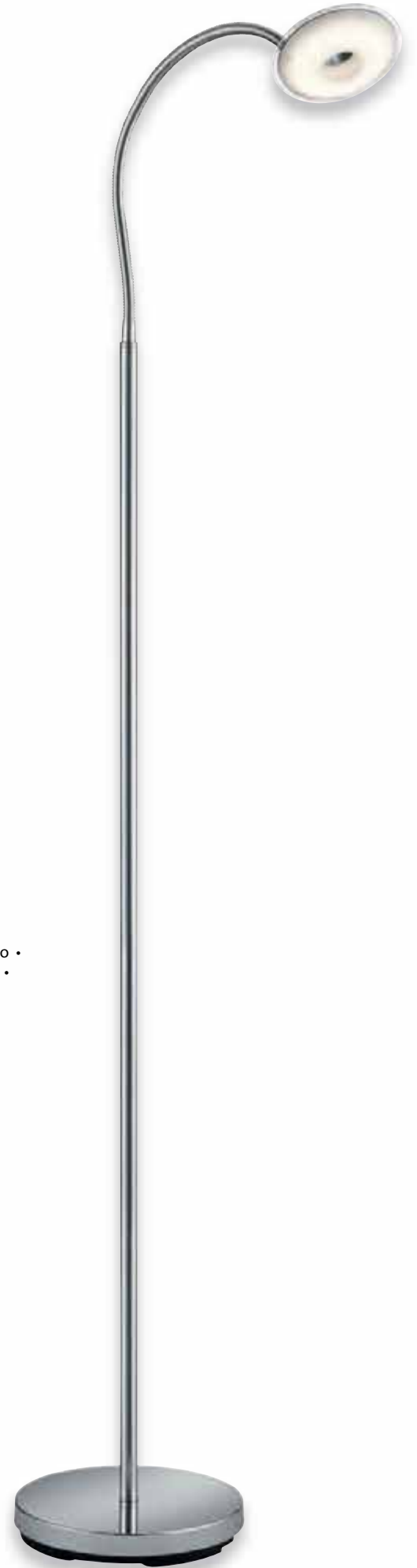

↓ 30 cm, ↗ 31,5 cm  
 incl. 1 x SMD, 3,8 W  
 350 lm, 3.000 K



575910106



↓ 125 cm, ↗ 45 cm  
 incl. 1 x SMD, 3,8 W  
 350 lm, 3.000 K



475910106



↔ 80 cm, ↓ 95 - 160 cm  
 incl. 4 x SMD, 3,8 W  
 4 x 350 lm, 3.000 K



375910406







## Pilatus

chrom, Acryl • chrome, acryl •  
 chrome, acryl • chroom, acryl • cromo, acrílico •  
 cromo, acrílico • crom, acrílic • kromi, akryyli •  
 chrom, akryl • krom, akrilik

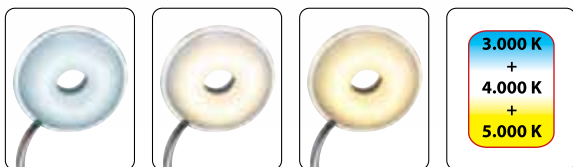

Ø 11 cm, 14 cm  
 incl. 1 x SMD, 3,8 W  
 350 lm, 3.000 K



875910106



↔ 34 cm, 16 cm  
 incl. 2 x SMD, 3,8 W  
 2 x 350 lm, 3.000 K



875910206



↔ 89 cm, 16 cm  
 incl. 4 x SMD, 3,8 W  
 4 x 350 lm, 3.000 K



875910406



↔ 180 cm, 16 cm  
 incl. 6 x SMD, 3,8 W  
 6 x 350 lm, 3.000 K



875910606



Ø 25 cm, 16 cm  
 incl. 3 x SMD, 3,8 W  
 3 x 350 lm, 3.000 K



875990306



↔ 74 x 38 cm, 18,5 cm  
 incl. 5 x SMD, 3,8 W  
 5 x 350 lm, 3.000 K



675910506



3.000 K  
+  
4.000 K  
+  
5.000 K



Ø 65 cm, ↑ 20 cm  
incl. 6 x SMD, 3,8 W  
6 x 350 lm, 3.000, 4.000, 5.000 K



675990606



Ø 86 cm, ↑ 20 cm  
incl. 9 x SMD, 3,8 W  
9 x 350 lm, 3.000, 4.000, 5.000 K



675990906



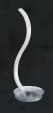
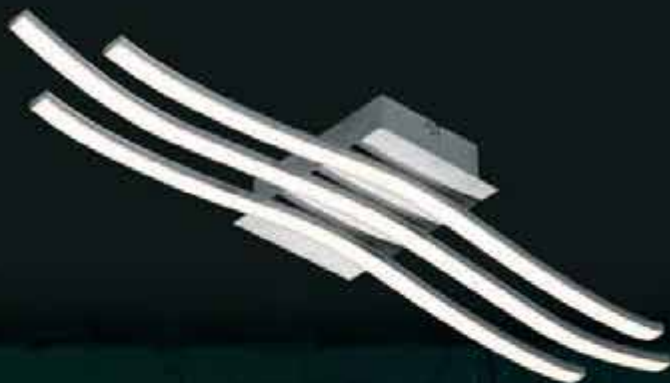

↑ 35 cm, Ø 12,5 cm  
incl. SMD, 6 W  
600 lm, 3.000 K



576410806



↑ 28 cm, ↔ 30 cm  
incl. SMD, 18 W  
1.600 lm, 3.000 K



576491806



↑ 150 cm, Ø 28 cm  
incl. SMD, 25 W  
2.300 lm, 3.000 K



476412506



↔ 60 x 15,5 cm, ↑ 6 cm  
incl. SMD, 24 W  
2.200 lm, 3.000 K



676412406



↔ 110 x 16 cm, ↑ 11 cm  
incl. SMD, 32 W  
3.000 lm, 3.000 K

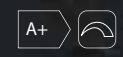

676413606





## Catoki

chrom, Acryl • chrome, acryl •  
chrome, acryl • chroom, acryl • cromo, acrílico • cromo, acrílico •  
crom, acrílic • kromi, akryyli • chrom, akryl • krom, akrilik



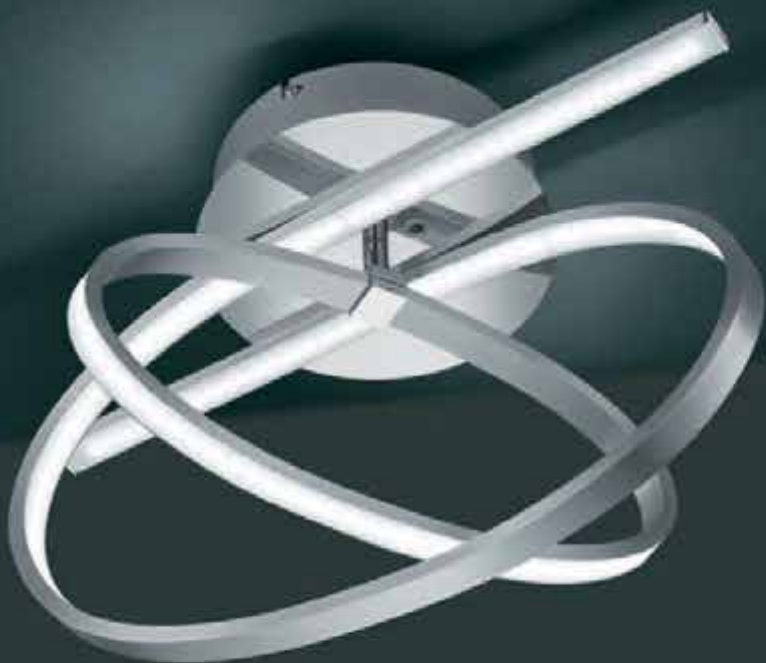

# Coronado

Aluminium gebürstet, chrom • brushed aluminium, chrome •  
 aluminium balayé, chrome • geborsteld aluminium, chroom •  
 aluminio pulido, cromo • alluminio spazzolato, cromo • aluminiu  
 lucios, crom • harjattu alumiini, kromi • aluminium szczotkowane,  
 chrom • alüminyum, krom



↔ 42 x 32 cm, ↑ 27 cm  
 incl. SMD, 30 W  
 2.500 lm, 3.000, 4.500, 6.500 K



674910106



↔ 42 x 32 cm, ↑ 150 cm  
 incl. SMD, 30 W  
 2.500 lm, 3.000, 4.500, 6.500 K



374910106



## Catoki II

chrom, Acryl • chrome, acryl •  
chrome, acryl • chroom, acryl • cromo, acrílico • cromo, acrílico •  
crom, acrílic • kromi, akryyli • chrom, akryl • krom, akrilik



↔ 88 x 15 cm, ↑ 8,5 cm  
incl. SMD, 20 W  
1.800 lm, 3.000 K

A+

676712406



# Quidam

Nickel matt oder weiß • nickel mat or white •  
nickel mat ou blanc • nikkell mat of wit • níquel mate o blanco •  
nichel opaco o bianco • nichel mat sau alb • harjattu teräs tai  
valkoinen • nikiel mat lub biały • mat nikel veya beyaz



Ø 12 cm, 16 cm  
incl. 1 x SMD, 4,5 W  
430 lm, 3.000 K



272490101  
272490107



10,5 cm, 25 cm  
incl. 1 x SMD, 4,5 W  
430 lm, 3.000 K



272480101  
272480107



100 - 150 cm, Ø 23 cm, 15 cm  
incl. 2 x SMD, 4,5 W  
2 x 430 lm, 3.000 K



472490201  
472490207



01 weiß • white  
07 Nickel matt • matt nickel









## Mamba

chrom, schwarz • chrome, black •  
 chrome, noir • chroom, zwart • cromo, negro • cromo, nero •  
 crom, negru • kromi, musta • chrom, czarny • krom, siyah



↓ 40 cm, ↗ 38 cm  
 incl. 1 x SMD, max. 4,5 W  
 400 lm, 3.000 K



525310102



↓ 135 cm, ↗ 50 cm  
 incl. 1 x SMD, max. 4,5 W  
 400 lm, 3.000 K



425310102



↗ 47 cm, Ø 18 cm  
 incl. 1 x SMD, max. 4,5 W  
 400 lm, 3.000 K



225370102







02



06

# Romino

Metall • metal •  
metale • metaal • metal • metallo •  
metal • metalli • metal • metal



Ø 40 cm, ↓ 22,5 cm  
incl. 3 x SMD, 4,5 W  
3 x 430 lm, 3.000 K

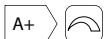

676510302  
676510306



Ø 40 cm, ↓ 150 cm  
incl. 3 x SMD, 4,5 W  
3 x 430 lm, 3.000 K

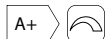

376510302  
376510306



02 schwarz • black  
06 chrom • chrome









## Trevor

Metall, titanfarbig • metal, titan •  
metale, titane • metaal, titaan • metal, titán • metallo, titano •  
metal, titaniu • metalli, titaani • metal, tytanowy • metal, titan



↓ 35 cm, ↗ 27 cm, Ø 11 cm  
incl. 1 x SMD, 4,5 W  
400 lm, 3.000 K



524610187



↓ 150 cm, ↗ 30 cm  
incl. 1 x SMD, 4,5 W  
400 lm, 3.000 K



424610187



Ø 19 cm, ↓ 130 cm  
incl. 1 x COB, 6,5 W  
570 lm, 3.000 K



324610187



04

07

09

# Jasper

Metall • metal •  
metale • metaal • metal • metallo •  
metal • metalli • metal • metal



Ø 31 cm, ↓ 150 cm  
excl. 1 x E27, max. 60 W

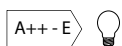

300500104  
300500107  
300500109



↓ 45 cm, ↗ 23 cm  
excl. 1 x E14, max. 40 W



500500104  
500500107  
500500109



↓ 140 cm, ↗ 52 cm  
excl. 1 x E14, max. 40 W



400500104  
400500107  
400500109



04 altmessing • old brass  
07 nickel matt • matt nickel  
09 kupferfarbig • copper





# Eva

Metall • metal •  
metale • metaal • metal • metallo •  
metal • metalli • metal • metal



118



Ø 25 cm, ↓ 150 cm  
excl. 1 x E14, max. 40 W

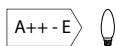

306400179  
306400189



Ø 20,5 cm, ↓ 22,5 cm  
excl. 1 x E14, max. 40 W



506400179  
506400189



79 schwarz/goldfarbig • black/gold-coloured  
89 schwarz/silberfarbig • black/silver-coloured

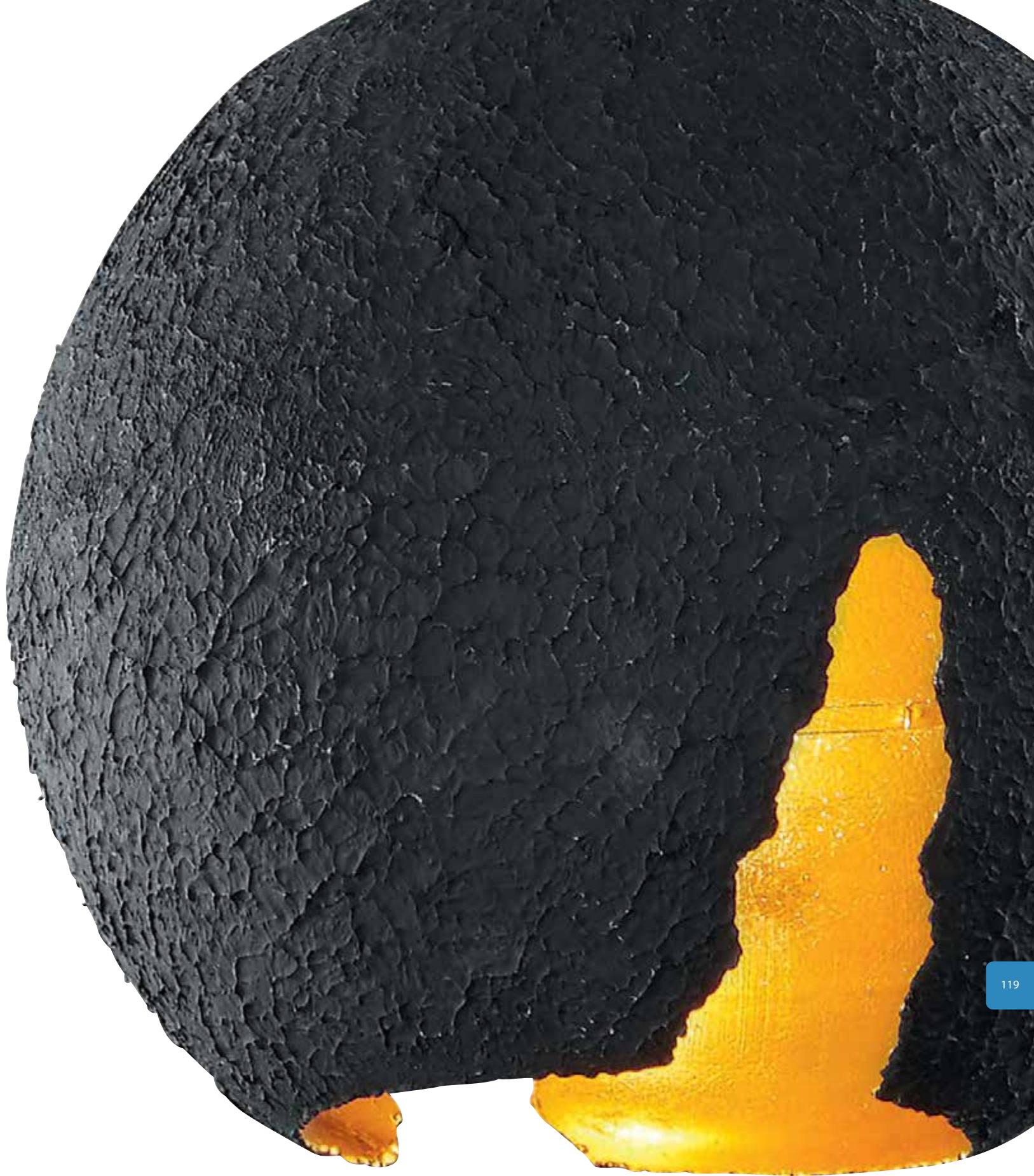



## Toulon

Metall, Glas matt • metal, mat glass •  
metale, verre mat • metaal, mat glas • metal, vidrio mate • metallo, vetro sabbiato •  
metal, sticla mata • metalli, mattalasi • metal, szkło matowane • metal, mat cam



↑ 150 cm, Ø 23 cm  
excl. 1 x E27, max. 60 W



304790101



↑ 150 cm, Ø 17 cm  
excl. 1 x E27, max. 60 W



304700101



↔ 80 x 17 cm, ↑ 120 cm  
excl. 3 x E27, max. 60 W



304700301



↑ 175 cm, Ø 25 cm  
excl. 1 x E27, max. 60 W

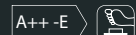

414700101



↑ 49 cm, Ø 17 cm  
excl. 1 x E27, max. 60 W

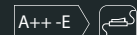

514700101



↔ 13 cm, ↑ 44 cm, ∠ 13 cm  
excl. 1 x E27, max. 60 W



204700101





# Big Apple

chrom, Glas opal • chrome, opal glass •  
chrome, verre opale • chroom, opaal glas • cromo, vidrio opal • cromo, vetro opale •  
crom, sticla opala • kromi, opaailasi • chrom, szkło opal • krom, opal cam



122



↑ 13,5 cm, Ø 15 cm  
incl. 1 x SMD, 5 W  
400 lm, 3.000 K



529710106



↑ 13 cm, Ø 50 cm  
incl. 3 x SMD, 5 W  
3 x 400 lm, 3.000 K



629710306



↑ 14 cm, Ø 68 cm  
incl. 5 x SMD, 5 W  
5 x 400 lm, 3.000 K



629710506



# Edison

Nickel matt, Glas matt • nickel mat, mat glass •  
 nickel mat, verre mat • nikkell mat, mat glas • níquel mate, vidrio mate •  
 nichel opaco, vetro sabbato • nichel mat, sticla mata • harjattu teräs,  
 mattalasi • nikiel mat, szkło matowane • mat nikel, mat cam



Ø 24,5 cm, ↑ 200 cm  
 excl. 1 x E27, max. 60 W

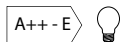

3401011-07



↔ 100 cm, ↓ 150 cm  
 excl. 5 x E14, max. 40 W

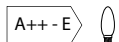

3401051-07



↑ 179 cm, Ø 24,5 cm  
 excl. 1 x E27, max. 60 W



4601011-07



↑ 43 cm, Ø 15 cm  
 excl. 1 x E14, max. 40 W

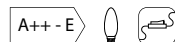

5601011-07







## Tornesh

Nickel matt oder rostfarbig, Glas alabasterfarbig •  
 nickel mat or rusty, alabaster-coloured glass • nickel mat ou rouille,  
 verre couleur albâtre • nikkel mat of roestkleur, albastkleurig glas •  
 níquel mate o óxido, vidrio de color alabastro • nichel opaco o  
 ruggine, vetro colore alabastro • nichel mat sau ruginiu, sticla  
 culoare alabastru • harjattu teräs tai rustiikki, lasi alabasteri väri •  
 nikiel mat lub miedz, szkło alabaster kolor • mat nikel veya pas, cam  
 kaymaktaşı rengi

**ECO**  
 HALOGEN



↑ 54 x 14 cm, ↗ 7 cm  
 incl. 1 x G9, 28 W  
 370 lm, 2.800 K



2670911-07  
 2670911-24



↑ 150 cm, Ø 26 cm  
 incl. 2 x G9, 28 W  
 2 x 370 lm, 2.800 K

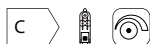

4470921-07  
 4470921-24



Ø 55 cm, ↓ 160 cm  
 incl. 5 x G9, 28 W  
 5 x 370 lm, 2.800 K



1170951-07  
 1170951-24



07 Nickel matt • matt nickel  
 24 rostfarbig • rusty











## Rustica

rostfarbig, Glas matt • rusty, mat glass •  
 rouille, verre mat • roestkleur, mat glas • óxido, vidrio mate •  
 ruggine, vetro sabbiato • ruginiu, sticla mata • rustiikki, mattalasi •  
 miedz, szkło matowane • pas, mat cam



Ø 40 cm, ↑ 150 cm  
 excl. 1 x E27, max. 60 W

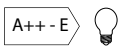

3402011-24



↔ 83 cm, ↑ 150 cm  
 excl. 2 x E27, max. 60 W

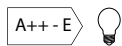

3402021-24



Ø 38 cm, ↑ 14 cm  
 excl. 2 x E27, max. 60 W

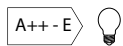

6102021-24



↑ 50 cm, Ø 33 cm  
 excl. 2 x E14, max. 40 W



5602021-24



↑ 180 cm, Ø 32,5 cm  
 excl. 1 x E27, max. 150 W



4602011-24



↑ 180 cm, Ø 32,5 cm  
 excl. 1 x E27, max. 100 W  
 excl. 1 x E14, max. 40 W



4602021-24

# Aaron

Nickel matt oder rostfarbig, Glas satiniert • nickel mat or rusty, satinated glass •  
nickel mat ou rouille, verre satiné • nikkell mat of roestkleur, gesatineerd glas •  
níquel mate o óxido, vidrio satinado • nichel opaco o ruggine, vetro satinato •  
nichel mat sau ruginiu, sticla satinata • harjattu teräs tai rustiikki, satinoitu lasi •  
nikiel mat lub miedz, szkło satynowe • mat nikel veyá pas, satin cam

**ECO**  
HALOGEN



↑ 26 cm, Ø 15,5  
incl. 1 x G9, 28 W  
370 lm, 2.800 K

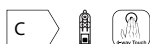

598210107  
598210124



↔ 90,5 cm, ↑ 80 - 200 cm  
incl. 4 x G9, 28 W  
4 x 370 lm, 2.800 K

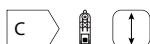

308210407  
308210424

**07** Nickel matt • matt nickel  
**24** rostfarbig • rusty









00

13

01



Ø 31 cm, ↓ 150 cm  
excl. 1 x E27, max. 40 W

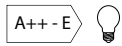

305600100  
305600101  
305600113



↓ 23 cm, Ø 20 cm  
excl. 1 x E14, max. 40 W



505600100  
505600101  
505600113



**00** transparent • transparent  
**01** weiß • white  
**13** amber • amber





00

13



01

## *Landino*

chrom, Acryl • chrome, acryl •  
chrome, acryl • chroom, acryl • cromo, acrílico • cromo, acrílico •  
crom, acrílic • kromi, akryyli • chrom, akryl • krom, akrilik



## Sweety

Acryl • acryl •  
acryl • acryl • acrílico • acrilico •  
acrilic • akryyli • akryl • akrilik



Ø 29 cm, ↓ 150 cm  
excl. 1 x E27, max. 60 W

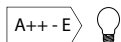

307900100



Ø 30 cm, ↓ 150 cm  
excl. 1 x E27, max. 60 W

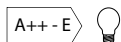

307800100



Ø 40 cm, ↓ 150 cm  
excl. 1 x E27, max. 60 W

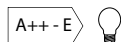

307804100



↑ 35 cm, Ø 23 cm  
excl. 1 x E14, max. 40 W

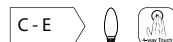

597800107



↑ 23 cm, Ø 25 cm  
excl. 1 x E14, max. 40 W

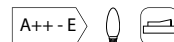

507800100



↔ 20 x 20 cm, ↗ 9 cm  
excl. 1 x E14, max. 40 W

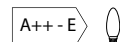

207800100



Ø 15 cm, † 10,5 cm  
excl. 1 x E27, max. 60 W

A++ - E 

607800100



00

16

92



↑ 30 cm, Ø 13 cm  
excl. 1 x E14, max. 40 W



593900100  
593900116  
593900192



Ø 20 cm, ↑ 150 cm  
excl. 1 x E27, max. 40 W

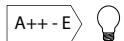

303900100  
303900116  
303900192



Ø 25 cm, ↑ 150 cm  
excl. 1 x E27, max. 40 W

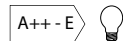

304200100  
304200116  
304200192



Ø 35 cm, ↑ 150 cm  
excl. 1 x E27, max. 60 W

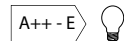

304290100



00 transparent • transparent  
16 gelb • yellow  
92 purpurrot • purple





## *Lacan*

chrom, Acryl • chrome, acryl •  
chrome, acryl • chroom, acryl • cromo, acrílico • cromo, acrílico •  
crom, acrílic • kromi, akryyli • chrom, akryl • krom, akrilik

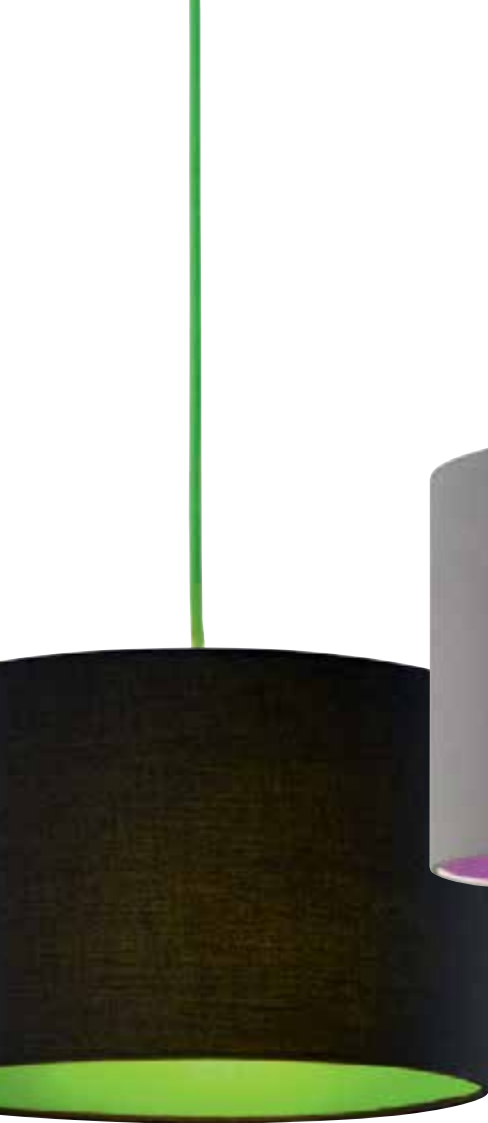

02



42



01

## Colorit

Stoff • fabric •  
tissu • textiel • tela • tessuto •  
textil • tekstiili • tkanina • kumaş



↓ 160 cm, Ø 32 cm  
excl. 1 x E27, max. 60 W

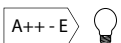

308500101  
308500102  
308500142



↓ 31 cm, Ø 20 cm  
excl. 1 x E14, max. 40 W



508500101  
508500102  
508500142



↓ 200 cm, ∠ 175 cm, Ø 41 cm  
excl. 1 x E27, max. 60 W



461200101  
461200102  
461200142



01 weiß • white  
02 schwarz • black  
42 anthrazit • anthracite









02



01



14

## Hotel

Nickel matt, Stoff • nickel mat, fabric •  
 nickel mat, tissu • nikkell mat, textiel • níquel mate, tela •  
 nichel opaco, tessuto • nichel mat, textil • harjattu teräs, tekstiili •  
 nikiel mat, tkanina • mat nikel, kumaş



↓ 32 cm, Ø 20 cm  
 excl. 1 x E14, max. 40 W



501100101  
 501100102  
 501100114



↓ 55 cm, Ø 30 cm  
 excl. 1 x E27, max. 60 W



511100101  
 511100102  
 511100114



Ø 40 cm, ↓ 150 cm  
 excl. 1 x E27, max. 60 W

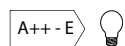

303300101  
 303300102  
 303300114



Ø 50 cm, ↓ 150 - 180 cm  
 excl. 3 x E27, max. 60 W



303300301  
 303300302  
 303300314



01 weiß • white  
 02 schwarz • black  
 14 braun • brown



Ø 30 cm, ↓ 16 cm  
excl. 2 x E14, max. 40 W

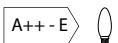

603900201  
603900202  
603900214



Ø 50 cm, ↓ 20,5 cm  
excl. 3 x E27, max. 60 W

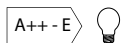

603900301  
603900302  
603900314



↓ 23,5 cm, Ø 20 cm, ∠ max. 34,5  
excl. 1 x E14, max. 40 W  
incl. 1 x COB, 3,2 W  
300 lm, 3.000 K



271170201  
271170202  
271170214



↓ 160 cm, Ø 35 cm  
excl. 1 x E27, max. 60 W



401100101  
401100102  
401100114



↓ 150 - 215 cm, Ø 30 cm, ∠ 107 cm  
excl. 1 x E27, max. 60 W



461100101  
461100102  
461100114



01 weiß • white  
02 schwarz • black  
14 braun • brown



## Hotel

Nickel matt, Stoff • nickel mat, fabric •  
nickel mat, tissu • nikkell mat, textiel • níquel mate, tela •  
nichel opaco, tessuto • nichel mat, textil • harjattu teräs, tekstiili •  
nikiel mat, tkanina • mat nikel, kumaş



## Cannes

Nickel matt oder chrom, Stoff • nickel mat or chrome, fabric •  
 nickel mat ou chrome, tissu • nikkell mat of chroom, textiel • níquel mate o cromo, tela •  
 nichel opaco o cromo, tessuto • nichel mat sau crom, textil • harjattu teräs tai kromi, tekstiili •  
 nikiel mat lab chrom, tkanina • mat nikel veya krom, kumaş



↑ 150 cm, Ø 40 cm  
 excl. 1 x E27, max. 60 W



300100106  
 300100107



↑ 152 cm, √ 50 cm  
 excl. 1 x E27, max. 60 W

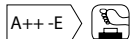

400100106  
 400100107



↑ 53 cm, √ 36 cm  
 excl. 1 x E27, max. 60 W

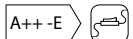

500100106  
 500100107



↔ 23 cm, ↑ 32,5 cm, √ 28,5 cm  
 excl. 1 x E27, max. 60 W



200100106  
 200100107



**06** chrom • chrome  
**07** Nickel matt • nickel mat





07



145



Ø 40 cm, ↓ 150 cm  
excl. 1 x E27, max. 60 W

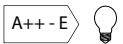

306500107



↓ 35 cm, Ø 20 cm  
excl. 1 x E14, max. 40 W



506500107



↓ 55 cm, Ø 30 cm  
excl. 1 x E27, max. 60 W



556500107



↓ 155 cm, Ø 40 cm  
excl. 1 x E27, max. 60 W



406500107

## Cosinus

Nickel matt, Stoff • nickel mat, fabric •  
nickel mat, tissu • nikkel mat, textiel • níquel mate, tela •  
nichel opaco, tessuto • nichel mat, textil • harjattu teräs, tekstiili •  
nikiel mat, tkanina • mat nikel, kumaş



# Stratos

chrom, Stoff • chrome, fabric •  
chrome, tissu • chroom, textiel • cromo, tela • cromo, tessuto •  
crom, textil • kromi, tekstiili • chrom, tkanina • krom, kumaş



↑ 120 cm, Ø 50 cm  
excl. 3 x E27, max. 60 W



303400306



↑ 150 cm, Ø 30 cm  
excl. 1 x E27, max. 40 W

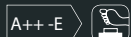

403400106



↑ 50 cm, Ø 23 cm  
excl. 1 x E27, max. 40 W

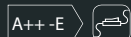

503400106



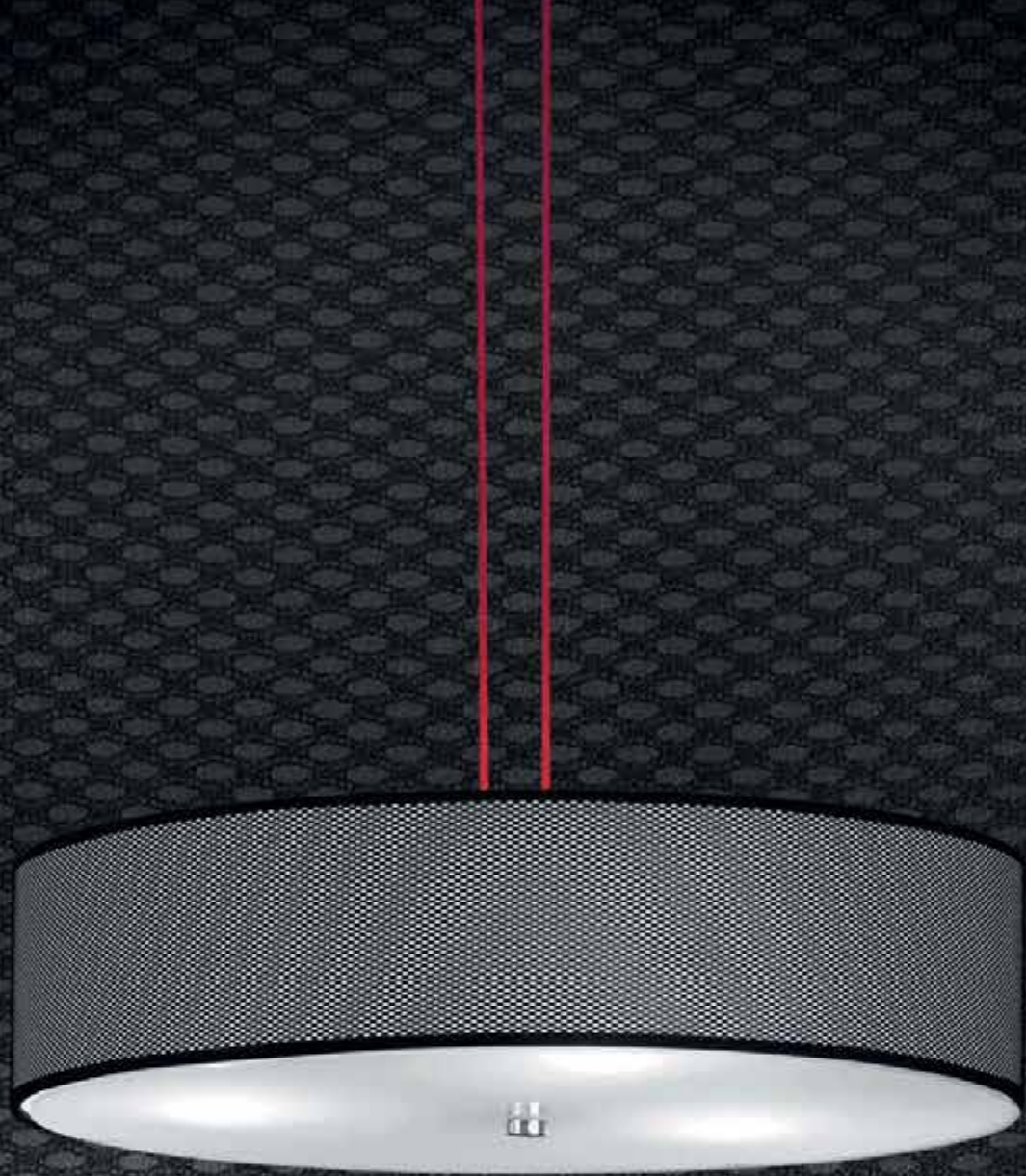



## Leyla

chrom, Organza • chrome, organza •  
 chrome, organza • chroom, organza • cromo, organza •  
 cromo, organza • crom, organza • kromi, organza •  
 chrom, organza • krom, organza



↑ 150 cm, Ø 38 cm  
 excl. 3 x E14, max. 40 W

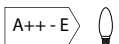

1121031-06



↑ 150 cm, Ø 50 cm  
 excl. 3 x E14, max. 40 W

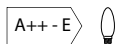

1121061-06



↑ 55 cm, Ø 35 cm  
 excl. 3 x E14, max. 40 W



5121031-06



↑ 150 cm, Ø 42 cm  
 excl. 5 x E14, max. 40 W



4021051-06







## Capital

chrom • chrome •  
 chrome • chroom • cromo • cromo •  
 crom • kromi • chrom • krom



↔ 22 cm, ↑ 17 cm, ↗ 11 cm  
 excl. 1 x E14, max. 40 W

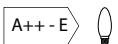

208400106



↑ 130 cm, Ø 40 cm  
 excl. 2 x E14, max. 40 W

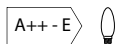

308400206



↑ 40 cm, Ø 12 cm  
 excl. 1 x E14, max. 40 W



598400106



↑ 150 cm, Ø 40 cm  
 excl. 2 x E14, max. 40 W

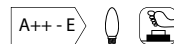

408400206







## Pinwheel

Aluminium • aluminium •  
aluminium • aluminium • aluminio • alluminio •  
aluminu • alumiini • aluminium • alüminyum

154



↑ 155 cm, Ø 62 cm  
excl. 9 x E14, max. 40 W

A++ · E

361300905



↑ 35 cm, Ø 62 cm  
excl. 5 x E14, max. 40 W

A++ · E

661300505







## Gracia

chrom, Acryl • chrome, acryl •  
chrome, acryl • chroom, acryl • cromo, acrílico •  
cromo, acrílico • crom, acrílic • kromi, akryyli •  
chrom, akryl • krom, akrilik



Ø 30 cm, ↑ 26 cm  
excl. 1 x E27, max. 60 W

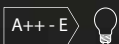

600400106



Ø 30 cm, ↑ 150 cm  
excl. 1 x E27, max. 60 W

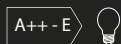

300400106





## Victoria

chrom, Acryl • chrome, acryl •  
chrome, acryl • chroom, acryl • cromo, acrílico •  
cromo, acrílico • crom, acrílic • kromi, akryyli •  
chrom, akryl • krom, akrilik

157



Ø 40 cm, ↑ 25 cm  
excl. 3 x E14, max. 40 W

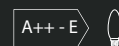

609700306



Ø 36 cm, ↑ 150 cm  
excl. 1 x E27, max. 60 W

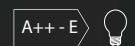

309700106

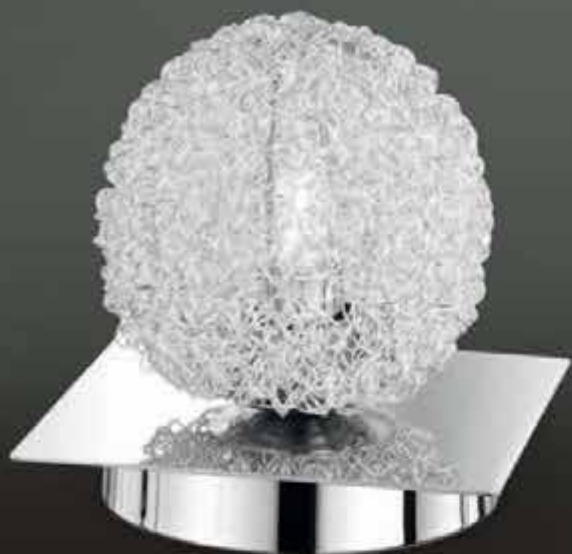

↔ 70 x 43 cm, ↑ 20 cm  
incl. 5 x G9, 28 W  
5 x 370 lm, 2.800 K



613210506



↑ 150 cm, ↔ 20 x 20 cm  
incl. 3 x G9, 28 W  
3 x 370 lm, 2.800 K



413210306



↑ 13 cm, ↔ 13 x 13 cm  
incl. 1 x G9, 28 W  
370 lm, 2.800 K



593210106





## *Juri*

chrom, Aluminiumgeflecht • chrome, aluminium meshwork •  
chrome, maillage aluminium • chrom, aluminium vlechtwerk •  
cromo, malla de aluminio • cromo, reticolo alluminio •  
crom, impletitura aluminium • kromi, alumiiniverkko •  
chrom, aluminium koronka • krom, alüminyum örgü

**ECO**  
HALOGEN







*Vintage*  
TRIO  
COLLECTION



Ø 31 cm, ↑ 150 cm  
excl. 1 x E27, max. 40 W

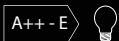

307500104  
307500161  
307500162



04 altmessing • old brass  
61 grau antik • gray antique  
62 kupferfarbig antik • copper-coloured antik

## Moni

Metall • metal •  
metale • metaal • metal • metallo •  
metal • metalli • metal • metal

Empfohlen:  
recommended:



Filament LED E27, 6 W  
600 lm, 3.000 K

A+

988-600



# Maira

Metall • metal •  
 metale • metaal • metal • metallo •  
 metal • metalli • metal • metal

Empfohlen:  
 recommended:



Filament LED E27, 6 W  
 420 lm, 2.700 K

A+

988-679



Ø 35 cm, ↑ 150 cm  
 excl. 1 x E27, max. 60 W

A++ - E



302000104  
 302000161  
 302000162



04 altmessing • old brass  
 61 grau antik • gray antique  
 62 kupferfarbig antik • copper-coloured antik





# Frieda

Metall • metal •  
 metale • metaal • metal • metallo •  
 metal • metalli • metal • metal



Ø 33 cm, ↓ 150 cm  
 excl. 1 x E27, max. 40 W

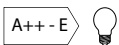

302200104  
 302200161  
 302200162



Ø 24 cm, ↓ 22 cm  
 excl. 1 x E14, max. 40 W



502200104  
 502200161  
 502200162



↔ 28 x 16 cm, ↗ 15 cm  
 excl. 1 x E14, max. 40 W

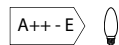

202200104  
 202200161  
 202200162



04 altmessing • old brass  
 61 grau antik • gray antique  
 62 kupferfarbig antik • copper-coloured antik









## Birdy

Metall • metal •  
metale • metaal • metal • metallo •  
metal • metalli • metal • metal



Ø 24,5 cm, ↓ 146 cm  
excl. 1 x E27, max. 60 W

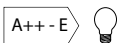

307600101

307600124



Ø 25 cm, ↓ 150 cm  
excl. 1 x E27, max. 60 W

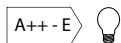

300900101

300900102



Ø 39 cm, ↓ 150 cm  
excl. 1 x E27, max. 60 W

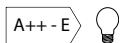

300700101

300700102



01 weiß • white  
02 schwarz • black  
24 rostfarbig • rusty



01



02



01

# Sanna

Metall • metal •  
metale • metaal • metal • metallo •  
metal • metalli • metal • metal

Empfohlen:  
recommended:



Filament LED E27, 6 W  
420 lm, 2.700 K

A+

987-679

02

# Tanja

Metall • metal •  
metale • metaal • metal • metallo •  
metal • metalli • metal • metal

Empfohlen:  
recommended:



Filament LED E27, 6 W  
420 lm, 2.700 K

A+

988-679



61



62

## Elsa

Metall, Glas klar • metal, clear glass •  
metale, verre claire • metaal, helder glas • metal, vidrio claro •  
metallo, vetro chiaro • metal, sticlă transparentă • metalli, kirkas lasi •  
metal, przezroczyste szkło • metal, şeffaf

Empfohlen:  
recommended:



Filament LED E27, 6 W  
420 lm, 2.700 K

A+

987-679



↔ 18,5 x 18,5 cm, ↑ 150 cm  
excl. 1 x E27, max. 60 W

A++ - E



302600161  
302600162



61 grau antik • gray antique  
62 kupferfarbig antik • copper-coloured antique

*Vintage*  
TRIO  
COLLECTION





07

04

## Margit

Metall, Glas • metal, glass •  
 metale, verre • metaal, glas • metal, vidrio • metallo, vetro •  
 metal, sticla • metalli, lasi • metal, szkło • metal, cam

Empfohlen:  
 recommended:



Filament LED E27, 6 W  
 600 lm, 3.000 K

A+

987-600



Ø 21 cm, ↑ 150 cm  
 excl. 1 x E27, max. 60 W

A++ - E

301500104  
 301500107



04 altmessing • old brass  
 07 Nickel matt • matt nickel



## Astrid

Metall, Glas klar • metal, clear glass •  
 metale, verre claire • metaal, helder glas •  
 metal, vidrio claro • metallo, vetro chiaro •  
 metal, sticlă transparentă • metalli, kirkas lasi •  
 metal, przezroczyste szkło • metal, şeffaf

Empfohlen:  
 recommended:



Filament LED E14, 4 W  
 400 lm, 3.000 K

A++

989-400

170



Ø 14,5 cm, ↑ 150 cm  
 excl. 1 x E14, max. 40 W

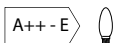

302700102



Ø 15 cm, ↑ 28 cm  
 excl. 1 x E14, max. 40 W



502700102



Ø 25 cm, ↑ 150 cm  
 excl. 1 x E27, max. 60 W

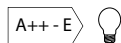

302100102  
 302100161  
 302100162



02 schwarz • black  
 61 grau antik • gray antique  
 62 kupferfarbig antik • copper-coloured antique

*Vintage*  
 TRIO  
 COLLECTION

## Berta

Metall, Glas klar • metal, clear glass •  
metale, verre claire • metaal, helder glas • metal, vidrio claro •  
metallo, vetro chiaro • metal, sticlă transparentă • metalli, kirkas lasi •  
metal, przezroczyste szkło • metal, şeffaf



61



02

62

171

Empfohlen:  
recommended:



Filament LED E27, 6 W  
600 lm, 3.000 K

A+

988-600



04



62



61



## Fisherman

Metall, Glas klar • metal, clear glass •  
 metale, verre claire • metaal, helder glas • metal, vidrio claro •  
 metallo, vetro chiaro • metal, sticlă transparentă • metalli, kirkas lasi •  
 metal, przezroczyste szkło • metal, şeffaf

Empfohlen:  
 recommended:



Filament LED E27, 4 W  
 400 lm, 3.000 K

A+

987-400

172



Ø 32 cm, † 150 cm  
 excl. 1 x E27, max. 28 W

A++ - E



304500104  
 304500161  
 304500162

04 altmessing • old brass  
 61 grau antik • gray antique  
 62 kupferfarbig antik • copper-coloured antik

*Vintage*  
 TRIO  
 COLLECTION







Ø 14,5 cm, ↓ 150 cm  
excl. 1 x E14, max. 40 W

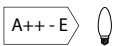

303800102  
303800161  
303800162



Ø 12,5 cm, ↓ 22 cm  
excl. 1 x E14, max. 40 W



503800102  
503800161  
503800162



**02** schwarz • black  
**61** grau antik • gray antique  
**62** kupferfarbig antik • copper-coloured antique





# Birte

Metall, Glas klar • metal, clear glass • metals, verre claire •  
metaal, helder glas • metal, vidrio claro • metallo, vetro chiaro •  
metal, sticlă transparentă • metalli, kirkas lasi •  
metal, przezroczyste szkło • metal, şeffaf

Empfohlen:  
recommended:



Filament LED E14, 4 W  
400 lm, 3.000 K

A++

989-400





## Judith

Glas klar • clear glass •  
verre claire • helder glas •  
vidrio claro • vetro chiaro •  
sticlă transparentă • kirkas lasi •  
przezroczyste szkło • şeffaf

Empfohlen:  
recommended:



Filament LED E27, 6 W  
420 lm, 2.700 K

A+

987-679



Ø 24,5 cm, ↓ 150 cm  
excl. 1 x E27, max. 60 W

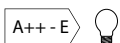

302900102



Ø 18 cm, ↓ 32,5 cm  
excl. 1 x E14, max. 40 W



503500104  
503500161  
503500162



02 schwarz • black  
04 altmessing • old brass  
61 grau antik • gray antique  
62 kupferfarbig antik • copper-coloured antik



04

61

62

## Linda

Metall, Glas klar • metal, clear glass •  
metale, verre claire • metaal, helder glas • metal, vidrio claro •  
metallo, vetro chiaro • metal, sticlă transparentă •  
metalli, kirkas lasi • metal, przezroczyste szkło • metal, şeffaf

Empfohlen:  
recommended:



Filament LED E14, 4 W  
400 lm, 3.000 K

A++

990-400



# Birte

Metall, Glas klar • metal, clear glass •  
metale, verre claire • metaal, helder glas •  
metal, vidrio claro • metallo, vetro chiaro •  
metal, sticlă transparentă • metalli, kirkas lasi •  
metal, przezroczyste szkło • metal, şeffaf

Empfohlen:  
recommended:



Filament LED E14, 4 W  
400 lm, 3.000 K

A++

989-400



Ø 30 cm, ↑ 120 cm  
excl. 5 x E14, max. 40 W

A++ - E



303800517



19



61



62

## Anna

Metall, Stoff • metal, fabric •  
metale, tissu • metaal, textiel •  
metal, tela • metallo, tessuto •  
metal, textil • metalli, tekstiili •  
metal, tkanina • metal, kumaş



Ø 15 cm, † 39,5 cm  
excl. 1 x E14, max. 40 W



502000119  
502000161  
502000162

19 türkis • turquoise  
61 grau antik • gray antique  
62 kupferfarbig antik • copper-coloured antique

**Vintage**  
TRIO  
COLLECTION



# Janko

Holz, Stoff • wood, fabric •  
bois, tissu • hout, textiel • mader, tela • di legno, tessuto •  
lemn, textil • puu, tekstiili • drewno, tkanina • tahta, kumaş



61



14



↓ 44 cm, ↗ 26 cm  
excl. 1 x E14, max. 40 W



507700114  
507700161

↓ 160 cm, ↗ 40 cm  
excl. 1 x E14, max. 40 W



407700114  
407700161

14 braun • brown  
61 grau antik • gray antique







## Concrete

Beton, grau • concrete, grey •  
béton, gris • beton, grijs • hormigón, gris • cemento, grigio •  
beton, gri • betoni, harmaa • beton, popielaty • beton, gri

Empfohlen:  
recommended:



LED GU10, 5 W  
400 lm, 3.000 K

A+

956-55

180



↔ 10 x 15 cm, ∠ 18 cm  
excl. 1 x GU10, max. 35 W



802500178



↔ 23 x 10 cm, ∠ 18 cm  
excl. 2 x GU10, max. 35 W

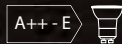

802500278



↔ 35 x 10 cm, ∠ 18 cm  
excl. 3 x GU10, max. 35 W

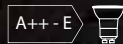

802500378

*Vintage*  
TRIO  
COLLECTION







04



61



62

## Irene

Metall • metal •  
metale • metaal • metal • metallo •  
metal • metalli • metal • metal



Ø 23,5 cm, ↑ 150 cm  
excl. 1 x E14, max. 40 W

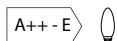

302300104  
302300161  
302300162



↔ 10,5 x 10,5 cm, ↑ 27,5 cm  
excl. 1 x E14, max. 40 W



503300104  
503300161  
503300162



↔ 15,5 x 15,5 cm, ↑ 34 cm  
excl. 1 x E14, max. 40 W



502500104  
502500161  
502500162



04 altmessing • old brass  
61 grau antik • gray antique  
62 kupferfarbig antik • copper-coloured antique



## Farina

Metall • metal •  
metale • metaal • metal • metallo •  
metal • metalli • metal • metal

## Jana

Metall • metal •  
metale • metaal • metal • metallo •  
metal • metalli • metal • metal







04



62



61

# Jasmin

Metall • metal •  
metale • metaal • metal • metallo •  
metal • metalli • metal • metal



Ø 19 cm, † 150 cm  
excl. 1 x E14, max. 40 W

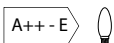

303700104  
303700161  
303700162



Ø 19 cm, † 36 cm  
excl. 1 x E14, max. 40 W



503700104  
503700161  
503700162



**04** altmessing • old brass  
**61** grau antik • gray antique  
**62** kupferfarbig antik • copper-coloured antik













## Pendelleuchten & Kronen

Pendants & chandeliers  
Lustres & suspensions  
Hanglampen & kroonluchters  
Colgantes y Lámparas  
Lampadari e sospensioni  
Lustre si pendule  
Riippu- & kruunu  
Wiszące i żyrandole  
Avize & Sarkıtlar



## Saturn

chrom, Acryl • chrome, acryl •  
chrome, acryl • chrom, acryl • cromo, acrílico • cromo, acrilico •  
crom, acrilic • kromi, akryyli • chrom, akryl • krom, akrilik



188



incl. SMD, 36 W  
↑ 130 cm, Ø 50 cm  
3.500 lm, 3.000 K



376013606









Gibt Licht nach oben und unten • up and down lighting •  
point lumineux en haut et en bas • lichtpunt boven en onder •  
luz de arriba y abajo • luce su e giù • sus şi în jos lumina •  
ylös ja alas valoa • w górę iw dół światło • yukarı ve aşağı ışık

## Salinero

Aluminium gebürstet, Acryl • brushed aluminium, acryl •  
aluminium balayé, acryl • geborsteld aluminium, acryl •  
aluminio pulido, acrílico • alluminio spazzolato, acrilico •  
aluminium lucios, acrilic • harjattu alumiini, akryyli •  
aluminium szczotkowane, akryl • alüminyum, akrilik



190



↔ 115 cm, † 90 - 150 cm  
incl. SMD, 30 W  
2.800 lm, 3.000 K



377590205









## Avenue

chrom, Glas • chrome, glas •  
 chrome, verre • chroom, glas • cromo, vidrio • cromo, vetro •  
 crom, sticla • kromi, lasi • chrom, szkło • krom, cam



↔ 110 x 9 cm, ↓ 120 cm  
 incl. 10 x SMD, 3,2 W  
 10 x 300 lm, 3.000 K



326311006







# Oslo

Aluminium gebürstet, Glas • brushed aluminium, glas •  
 aluminium balayé, verre • geborsteld aluminium, glas • aluminio pulido, vidrio • alluminio spazzolato, vetro •  
 aluminiu lucios, sticla • harjattu alumiini, lasi • aluminium szczotkowane, szkło • alüminyum, cam



↔ 85 x 12 cm, ↑ 95 - 160 cm  
 incl. 4 x SMD, 4,5 W  
 4 x 430 lm, 3.000 K



378790405



↔ 110 x 16 cm, ↑ 120 cm  
 incl. 5 x SMD, 4,5 W  
 5 x 430 lm, 3.000 K

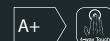

378790505



## Senator

Nickel matt oder Messing matt, Glas matt • nickel mat or brass mat, mat glass •  
 nickel mat ou laiton mat, verre mat • nikkel mat of messing mat, mat glas •  
 níquel mate o bronze mate, vidrio mate • nichel opaco o ottone satinato, vetro sabbato •  
 nichel mat sau bronz mat, sticla mata • harjattu teräs tai mattamessinki, mattalasi •  
 nikiel mat lub mosiądz mat, szkło matowane • mat nikel veya mat pirinç, mat cam



↔ 90 x 8 cm, ↓ 95 - 160 cm  
 incl. 4 x SMD, 4,5 W  
 4 x 430 lm, 3.000 K



324390407  
 324390408



↔ 110 x 8 cm, ↓ 150 cm  
 incl. 5 x SMD, 4,5 W  
 5 x 430 lm, 3.000 K

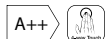

324390507



**07** Nickel matt • nickel mat  
**08** Messing matt • matt brass



08

# Calvaro

Aluminium gebürstet, Acryl • brushed aluminium, acryl •  
aluminium balayé, acryl • geborsteld aluminium, acryl •  
aluminio pulido, acrílico • alluminio spazzolato, acrilico •  
aluminiumu lucios, acrilic • harjattu alumiini, akryyli •  
aluminiumu szczotkowane, akryl • alüminyum, akrilik



↔ 80 x 2,5 cm, ↑ 90 - 150 cm  
incl. SMD, 20 W  
1.900 lm, 3.000 K



377690105





## Cavallo

Aluminium gebürstet • brushed aluminium •  
aluminium balayé • geborsteld aluminium • aluminio pulido •  
alluminio spazzolato • aluminiu lucios • harjattu alumiini •  
aluminium szczotkowane • alüminyum



↔ 100 x 5 cm, ↑ 95 - 160 cm  
incl. 5 x SMD, 4,5 W  
5 x 430 lm, 3.000 K



379090505

# Matteo

Nickel matt, Glas satiniert • nickel mat, satinated glass •  
nickel mat, verre satiné • nikkell mat, gesatineerd glas •  
níquel mate, vidrio satinado • nichel opaco, vetro satinato •  
nichel mat, sticla satinata • harjattu teräs, satinoitu lasi •  
nikiel mat, szkło satynowe • mat nikel, satin cam



↔ 80 x 10 cm, ↑ 90 - 160 cm  
incl. 4 x SMD, 4,5 W  
4 x 400 lm, 3.000 K



329610407



## Voltaire

chrom, Acryl • chrome, acryl •  
chrome, acryl • chroom, acryl • cromo, acrílico • cromo, acrílico •  
crom, acrílic • kromi, akryyli • chrom, akryl • krom, akrilik



↔ 78 x 1,5 cm, ↑ 95 - 140 cm  
incl. 4 x SMD, 4,6 W  
4 x 430 lm, 3.000 K

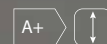

324510406



## Elias

Aluminium gebürstet, chrom, Glas satiniert • brushed aluminium, chrome, satinated glass •  
aluminium balayé, chrome, verre satiné • geborsteld aluminium, chrom, gesatineerd glas •  
aluminio pulido, cromo, vidrio satinado • alluminio spazzolato, cromo, vetro satinato •  
aluminium lucios, crom, sticla satinata • harjattu alumiini, kromi, satinoitu lasi •  
aluminium szczotkowane, chrom, szkło satynowe • alüminyum, krom, satin cam

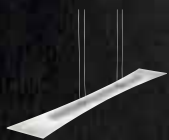

↔ 100 x 15 cm, ↑ 120 cm  
incl. 4 x COB, 5 W  
4 x 300 lm, 3.000 K

A

322510406



# Stakkato

Nickel matt, Glas satiniert •  
nickel mat, satinated glass •  
nickel mat, verre satiné • nikkell mat, gesatineerd  
glas • níquel mate, vidrio satinado • nichel opaco,  
vetro satinato • nichel mat, sticla satinata •  
harjattu teräs, satinoitu lasi • nikiel mat, szkło  
satynowe • mat nikel, satin cam



↔ 87 x 10 cm, ↑ 95 - 150 cm  
incl. 3 x SMD, 4,5 W  
3 x 430 lm, 3.000 K



377310307



↓ 130 cm, Ø 9 cm  
incl. 1 x COB, 4,5 W  
1 x 350 lm, 3.000 K



327910105



↔ 80 x 8 cm, ↓ 130 cm  
incl. 4 x COB, 4,5 W  
4 x 350 lm, 3.000 K



327910405



↔ max. 150 cm, ↓ 80 - 150 cm  
incl. 2 x COB, 4,5 W  
2 x 350 lm, 3.000 K

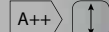

327910205



↓ 130 cm, Ø 40 cm  
incl. 5 x COB, 4,5 W  
5 x 350 lm, 3.000 K



327930505



## Drops

Aluminium gebürstet, Acryl • brushed aluminium, acryl •  
aluminium balayé, acryl • geborsteld aluminium, acryl • aluminio pulido, acrílico •  
alluminio spazzolato, acrílico • aluminiu lucios, acrilic • harjattu alumiini, akryyli •  
aluminium szczotkowane, akryl • alüminyum, akrilik





## Ramiro

chrom oder schwarz • chrome or black •  
 chrome ou noir • chrom of zwart • cromo o negro •  
 cromo o nero • crom sau negru • kromi tai musta •  
 chrom lub czarny • krom veya siyah



↔ 100 x 8,5 cm, ↓ 150 cm  
 incl. 4 x SMD, 4,5 W  
 4 x 430 lm, 3.000 K



376410402 C 376410402 Smart Control  
 376410406 C 376410406 Smart Control



02 schwarz • black  
 06 chrom • chrome





## Montreal

Nickel matt oder rostfarbig antik • nickel mat or antique rust •  
 nickel mat ou rouille antique • nikkell mat of roestkleur antiek •  
 níquel mate o oxido • nichel opaco o ruggine anticato •  
 nichel mat sau ruginiu antic • harjattu teräs tai rustiikki •  
 nikiel mat lub antyczny rdzawy • mat nikel veyá antik pas rengi



↔ 100 x 10 cm, ↓ 150 cm  
 incl. 5 x SMD, 4,5 W  
 5 x 430 lm, 3.000 K

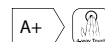

376790507  
 376790528



**07** Nickel matt • nickel mat  
**28** rostfarbig antik • antique rust

02



206



↑ 140 cm, Ø 40 cm  
incl. 3 x SMD, 4,5 W  
3 x 430 lm, 3.000 K



376610302  
376610307  
376610309



**02** schwarz • black  
**07** nickel matt • matt nickel  
**09** kupferfarbig • copper-coloured

07



09



## Naples

Metall, Spiegelglas gecrasht • metal, crashed mirror glass •  
metale, miroir de crash • metaal, espejos de choque •  
metallo, vostro spechhio schiantato • metal, sticla oglinda prăbușit •  
metalli, crash peilit • metal, lusterka zderzeniowe • metal, çarpışma aynalar





06



32



62

## Romino II

Metall • metal •  
metale • metaal • metal • metallo •  
metal • metalli • metal • metal

208



Ø 50 cm, ↓ 150 cm  
excl. 1 x E27, max. 60 W

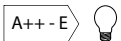

308000106  
308000132  
308000162



**06** chrom • chrome  
**32** schwarz matt • black mat  
**62** kupfer antik • antique copper





## Ramses

Metall, Spiegelglas gecrasht • metal, crashed mirror glass •  
 metal, miroir de crash • metaal, gecrasht spiegelglas •  
 metal, espejos de choque • metallo, vetro spechhio schiantato •  
 metal, sticla oglinda prăbușit • metalli, crash peilit •  
 metal, lusterka zderzeniowe • metal, çarpışma aynalar



Ø 40,5 cm, ↓ 150 cm  
 excl. 1 x E27, max. 60 W

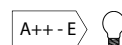

307400101  
 307400102  
 307400107  
 307400162



**01** weiß • white  
**02** schwarz • black  
**07** Nickel matt • nickel mat  
**62** kupfer antik • antique copper



## Ottawa

Metall • metal •  
metale • metaal • metal • metallo •  
metal • metalli • metal • metal

210



Ø 50 cm, ↓ 150 cm  
excl. 1 x E27, max. 60 W

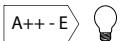

305700109  
305700179  
305700189



09 kupferfarbig • copper  
79 goldfarbig • gold  
89 silberfarbig • silver

79



211

## Boston

Nickel matt oder kupfer matt • matt nickel or copper mat •  
 nickel mat ou cuivre mat • nikkell mat of koper mat • níquel mate o estera de cobre •  
 nichel opaco o rame opaco • nichel mat sau cupru mat • harjattu teräs tai kupari mat •  
 nikiel mat lub miedz mat • mat nikel veya bakir mat



212



↑ 160 cm, Ø 39 cm  
 excl. 1 x E27, max. 60 W

A++ - E

301800107  
 301800129



07 nickel matt • matt nickel  
 29 kupferfarbig matt • copper-coloured matt





07



62



05

## Maniac

Metall, Kunststoff • metal, plastic •  
metale, plastique • metaal, kunststof •  
metal, plástico • metallo, plastica • metal, plastic •  
metalli, muovi • metal, plastik • metal, plastik



Ø 41 cm, ↑ 160 cm  
excl. 1 x E27, max. 60 W

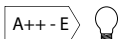

307300105  
307300162



**05** Aluminium gebürstet • brushed aluminium  
**62** kupfer antik • antique copper

64

07



## Greta

Metall • metal •  
metale • metaal • metal • metallo •  
metal • metalli • metal • metal

215



Ø 40,5 cm, ↑ 150 cm  
excl. 1 x E27, max. 60 W

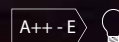

302400107  
302400164



**07** Nickel matt • nickel mat  
**64** bronze • bronze



## Slash

Aluminium gebürstet • brushed aluminium •  
aluminium balayé • geborsteld aluminium • aluminio pulido •  
alluminio spazzolato • aluminiu lucios • harjattu alumiini •  
aluminium szczotkowane • alüminyum



## Cantus

Metall, Glas klar • metal, clear glass •  
metale, verre claire • metaal, helder glas • metal, vidrio claro •  
metallo, vetro chiaro • metal, sticlă transparentă • metalli, kirkas lasi •  
metal, przezroczyste szkło • metal, şeffaf



Ø 30 cm, ↓ 135 cm  
excl. 1 x E27, max. 60 W

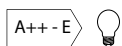

300203005



Ø 40 cm, ↓ 141 cm  
excl. 1 x E27, max. 60 W

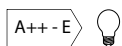

300204005



Ø 22 cm, ↓ 150 cm  
excl. 1 x E14, max. 40 W

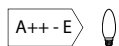

309600106  
309600109



**06** chrom • chrome  
**09** kupferfarbig • copper



# Kannan

Aluminium gebürstet oder weiß • brushed aluminium or white • aluminium balayé ou blanc • geborsteld aluminium of wit • aluminio pulido o blanco • alluminio spazzolato o bianco • aluminiu lucios sau alb • harjattu alumiini tai valkoinen • aluminium szczotkowane lub biały • alüminyum veya beyaz



05



01

# Nabab

Aluminium gebürstet oder weiß • brushed aluminium or white • aluminium balayé ou blanc • geborsteld aluminium of wit • aluminio pulido o blanco • alluminio spazzolato o bianco • aluminiu lucios sau alb • harjattu alumiini tai valkoinen • aluminium szczotkowane lub biały • alüminyum veya beyaz



217



01 weiß • white  
05 Aluminium gebürstet • brushed Aluminium



Ø 20 cm, ↓ 130 cm  
excl. 1 x E27, max. 28 W

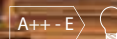

306200101  
306200105



Ø 36 cm, ↓ 138 cm  
excl. 1 x E27, max. 42 W



306300101  
306300105



## Roddik

Polyresin, betonfarbig • polyresin, concrete look •  
 polyresin, couleur beton • polyresin, beton kleur •  
 poliresina, color concreto • poliestere, calcestruzzo •  
 polirasina, culoare beton • polyresini, konkreettisia väri •  
 polyresin, konkretny kolor • polirezin, beton rengi



Ø 16 cm, ↓ 150 cm  
 excl. 1 x E14, max. 40 W

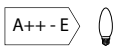

301100178



↔ 80 cm, ↓ 150 cm  
 excl. 3 x E14, max. 40 W

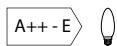

301100378



Ø 27,5 cm, ↓ max. 150 cm  
 excl. 1 x E27, max. 60 W

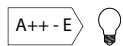

301190178





00



42

220

## Calais

Glas • glass •  
verre • glas • vidrio • vetro • sticla • lasi • szkło • cam



↑ 130 cm, Ø 20 cm  
excl. 1 x E27, max. 60 W

A++ - E



304800100  
304800142

00 natur • nature  
42 anthrazit • anthracite



42

00



## Dover

Glas • glass •  
verre • glas • vidrio • vetro • sticla • lasi • szkło • cam



‡ 130 cm, Ø 39,5 cm  
excl. 1 x E27, max. 60 W

A++-E

304900100  
304900142



00 natur • nature  
42 anthrazit • anthracite



## Edison II

chrom, Glas klar • chrome, clear glass •  
 chrome, verre claire • chroom, helder glas •  
 cromo, vidrio claro • cromo, vetro chiaro •  
 crom, sticlă transparentă • kromi, kirkas lasi •  
 chrom, przezroczyste szkło • krom, şeffaf



Ø 20 cm, ↑ 120 cm  
 excl. 1 x E27, max. 40 W

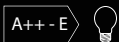

340100106



Ø 28 cm, ↑ 130 cm  
 excl. 1 x E27, max. 40 W

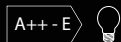

340190106



02



## Chiara

chrom, Acryl • chrome, acryl •  
chrome, acryl • chroom, acryl •  
cromo, acrílico • cromo, acrílico •  
crom, acrílic • kromi, akryyli •  
chrom, akryl • krom, akrilik



Ø 50 cm, ↑ 150 cm  
excl. 5 x E14, max. 40 W

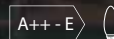

110400501  
110400502



01 weiß • white  
02 schwarz • black



## Swirl

chrom, Aluminiumgeflecht • chrome, aluminium meshwork •  
 chrome, maillage aluminium • chroom, aluminium vlechtwerk •  
 cromo, malla de aluminio • cromo, reticolo alluminio •  
 crom, impletitura aluminu • kromi, alumiiniverkko •  
 chrom, aluminium koronka • krom, alüminyum örgü



## Luca

chrom, Acryl • chrome, acryl •  
 chrome, acryl • chroom, acryl • cromo, acrílico •  
 cromo, acrílico • crom, acrílic • kromi, akryyli •  
 chrom, akryl • krom, akrilik



Ø 30 cm, ↑ 150 cm  
 excl. 1 x E27, max. 60 W

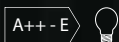

308300106



Ø 48 cm, ↑ 150 cm  
 excl. 5 x E14, max. 40 W

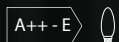

309400506



# Ultimo

chrom, Acryl • chrome, acryl •  
chrome, acryl • chroom, acryl • cromo, acrílico •  
cromo, acrílico • crom, acrílic • kromi, akryyli •  
chrom, akryl • krom, akrilik

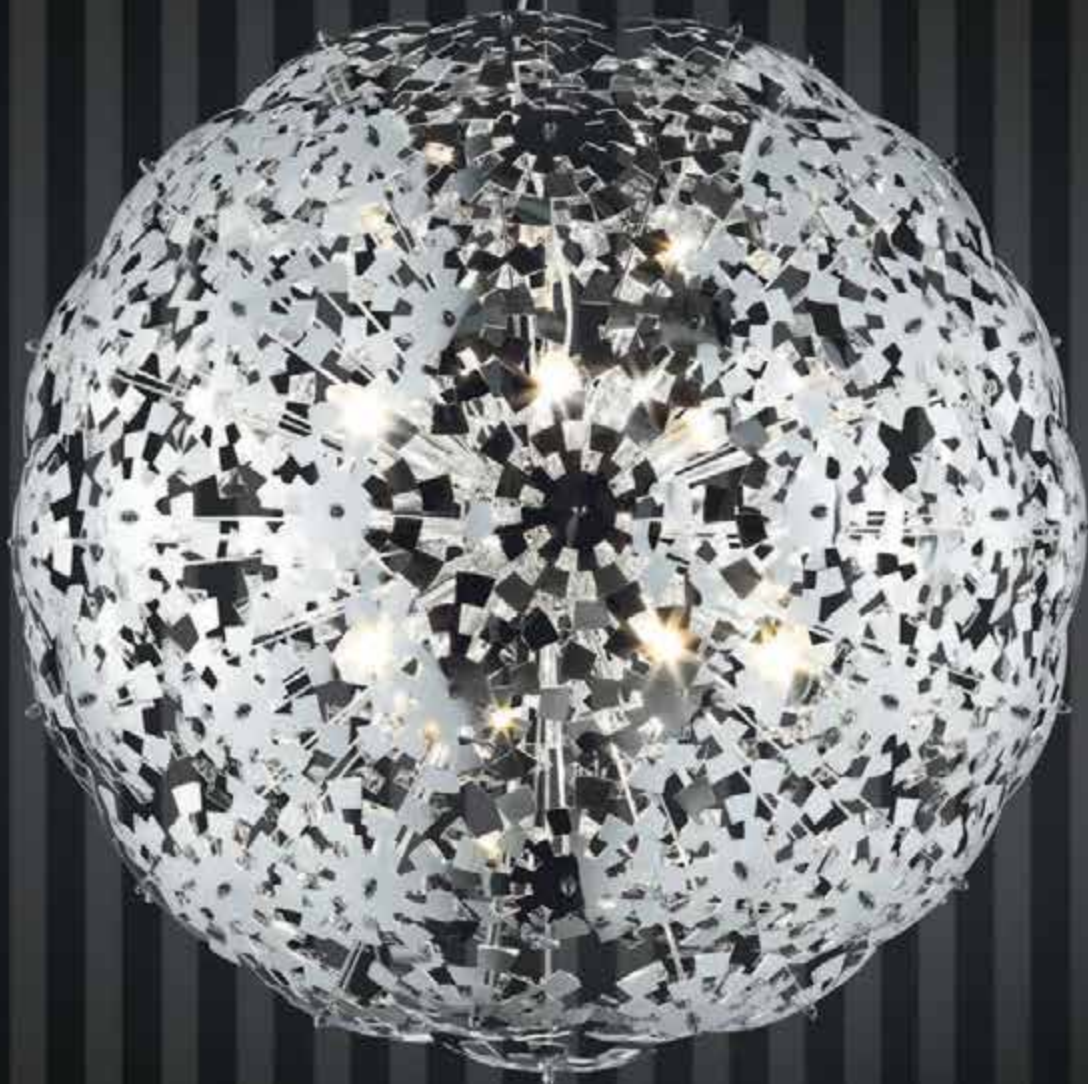

225



Ø 75 cm, ↑ 180 cm  
excl. 7 x E14, max. 40 W



302800706



## Montender

Metall, Glas matt • metal, mat glass •  
 metale, verre mat • metaal, mat glas • metal, vidrio mate •  
 metallo, vetro sabbiato • metal, sticla mata • metalli, mattalasi •  
 metal, szkło matowane • metal, mat cam



Ø 40 cm, ↓ 150 cm  
 excl. 1 x E27, max. 60 W

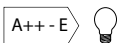

301900104  
 301900107  
 301900162

**04** altmessing • old brass  
**07** Nickel matt • nickel mat  
**62** kupfer antik • antique copper

# Classico

rostfarbig, Glas amber • rusty, amber glass •  
rouille, verre ambre • roestkleur, amber glas •  
óxido, vidrio ámbar • ruggine, vetro ambra •  
ruginiu, sticla amber • rustiikki, lasi meripihka •  
miedź, szkło bursztynowy • pas, amber cam

Empfohlen:  
recommended:



Filament LED E14, 4 W  
400 lm, 3.000 K

A++

990-400



227



Ø 57 cm, 1 172 cm  
excl. 5 x E14, max. 40 W

A++ - E



1199051-24



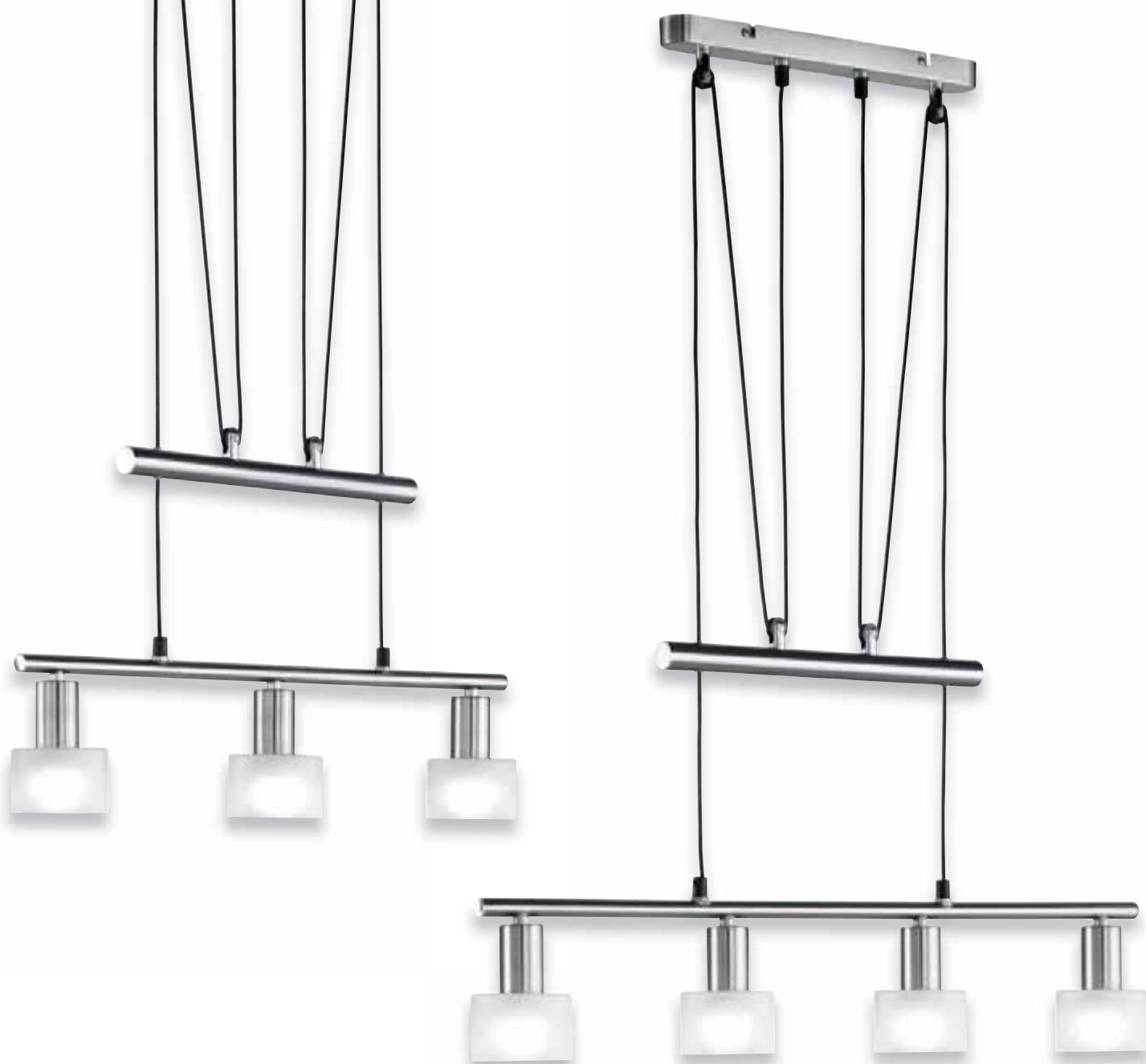

## Victor

Nickel matt, Glas matt • nickel mat, mat glass •  
 nickel mat, verre mat • nikkell mat, mat glas • níquel mate, vidrio mate •  
 nichel opaco, vetro sabbaiato • nichel mat, sticla mata • harjattu teräs, mattalasi •  
 nikiel mat, szkło matowane • mat nikel, mat cam



LED E14, 4 W  
 320 lm, 3.000 K

A+

983-40



↔ 60,5 cm, ↑ 80 - 180 cm  
 incl. 3 x LED E14, 4 W  
 3 x 320 lm, 3.000 K



322210307

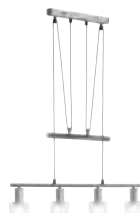

↔ 75 cm, ↑ 80 - 180 cm  
 incl. 4 x LED E14, 4 W  
 4 x 320 lm, 3.000 K



322210407



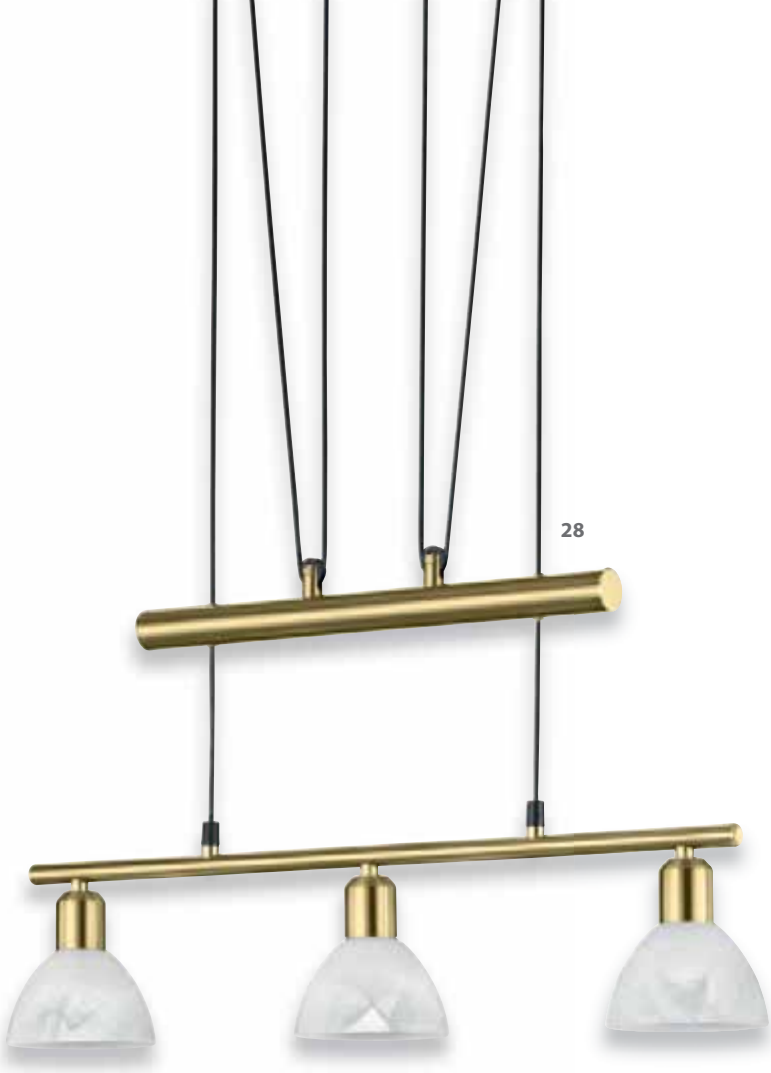

28



07

## Levisto

Metall, Glas alabasterfarbig • metal, alabaster-coloured glass •  
 metale, verre couleur albâtre • metaal, albastkleurig glas •  
 metal, vidrio de color alabastro • metallo, vetro colore alabastro •  
 metal, sticla culoare alabastru • metalli, lasi alabasteri väri •  
 metal, szkło alabaster kolor • metal, cam kaymaktaşı rengi



LED E14, 6 W  
 470 lm, 3.000 K

A+

983-60



↔ 60,5 cm, ↑ 95 - 160 cm  
 incl. 3 x LED E14, 6 W  
 3 x 470 lm, 3.000 K



371010307  
 371010308  
 371010328



↔ 80,5 cm, ↑ 95 - 160 cm  
 incl. 4 x LED E14, 6 W  
 4 x 470 lm, 3.000 K



371010407  
 371010408  
 371010428



**07** Nickel matt • nickel mat  
**08** Messing matt • brass mat  
**28** rostfarbig antik • antique rust

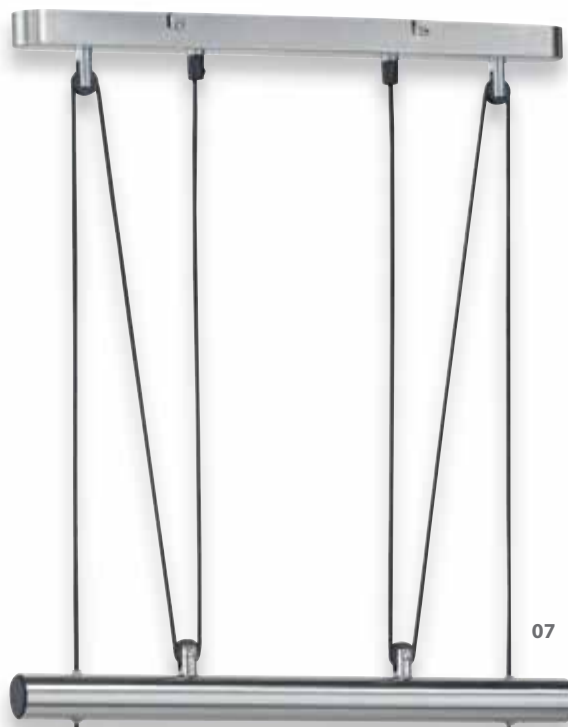

↔ 42 cm, ↓ 80 - 180 cm  
excl. 2 x E14, max. 40 W



3751021-07

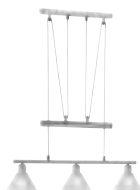

↔ 66 cm, ↓ 80 - 180 cm  
excl. 3 x E14, max. 40 W



3751031-07  
3751031-24

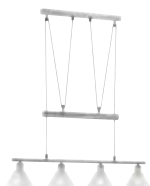

↔ 80 cm, ↓ 80 - 180 cm  
excl. 4 x E14, max. 40 W



3751041-07  
3751041-24



↔ 102 cm, ↓ 80 - 180 cm  
excl. 5 x E14, max. 40 W



3751051-07  
3751051-24



07 Nickel matt • nickel mat  
24 rostfarbig • rusty



## Stamina

Nickel matt oder rostfarbig, Glas • nickel mat or rusty, glass •  
nickel mat ou rouille, verre • nikkell mat of roestkleur, glas •  
níquel mate o óxido, vidrio • nichel opaco o ruggine, vetro •  
nichel mat sau ruginiu, sticla • harjattu teräs tai rustiikki, lasi •  
nikiel mat lub miedź, szkło • mat nikel veyá pas, cam



## Colin

Metall, Glas • metal, glass •  
 metale, verre • metaal, glas • metal, vidrio •  
 metallo, vetro • metal, sticla • metalli, lasi •  
 metal, szkło • metal, cam



## Viola

Glas alabasterfarbig • alabaster-coloured glass •  
 verre couleur albâtre • albastkleurig glas •  
 vidrio de color alabastro • vetro colore alabastro •  
 sticla culoare alabastru • lasi alabasteri vâri •  
 szkło alabaster kolor • cam kaymaktaşı rengi



Ø 38,5 cm, ↓ 70 - 130 cm  
 excl. 1 x E27, max. 60 W



301700107  
 301700108



Ø 40 cm, ↓ 130 cm  
 excl. 1 x E27, max. 60 W

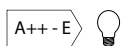

3407011-07  
 3407011-24



**07** Nickel matt • nickel mat  
**08** Messing matt • brass mat  
**24** rostfarbig • rusty



## Grannus

Nickel matt, Stoff • nickel mat, fabric •  
nickel mat, tissu • nikkel mat, textiel •  
níquel mate, tela • nichel opaco, tessuto •  
nichel mat, textil • harjattu teräs, tekstiili •  
nikiel mat, tkanina • mat nikel, kumaş

233



Ø 38 cm, ↑ 150 cm  
excl. 1 x E27, max. 60 W

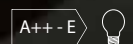

304300107



## Diego

Kunststoff, Glas • plastic, glass •  
 plastique, verre • kunststof, glas • plástico, vidrio •  
 plastica, vetro • plastic, sticla • muovi, lasi •  
 plastik, szkło • plastik, cam



Ø 30 cm, ↑ 125 cm  
 excl. 1 x E27, max. 60 W

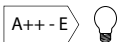

- 301400101
- 301400112
- 301400115
- 301400124
- 301400192

- 01** weiß • white
- 12** blau • blue
- 15** grün • green
- 24** amber • amber
- 92** purpurrot • purple



## Sofia

Metall, Glas alabasterfarbig • metal, alabaster-coloured glass •  
 metale, verre couleur albâtre • metaal, albastkleurig glas •  
 metal, vidrio de color alabastro • metallo, vetro colore  
 alabastro • metal, sticla culoare alabastru •  
 metalli, lasi alabasteri väri • metal, szkło alabaster kolor •  
 metal, cam kaymaktaşı rengi



## Carbonado

Dekorglas • glas decorated •  
 verre décoré • decoratief glas • vidrio decorado •  
 vetro decorato • sticla decorativa • ornamentilasi •  
 szkło dekoracyjne • dekoratif cam

235



Ø 43 cm, ↓ 150 cm  
 excl. 1 x E27, max. 40 W

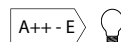

302400106



Ø 35 cm, ↓ 150 cm  
 excl. 1 x E27, max. 60 W

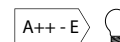

3414011-01  
 3414011-24



01 weiß • white  
 24 rostfarbig • rusty



06



00

92



51

## Zucca

chrom, Acryl • chrome, acryl •  
 chrome, acryl • chroom, acryl • cromo, acrílico •  
 cromo, acrílico • crom, acrylic • kromi, akryyli •  
 chrom, akryl • krom, akrilik



Ø 40 cm, ↑ 150 cm  
 excl. 1 x E27, max. 60 W

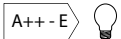

304100100  
 304100106  
 304100192

Ø 25 cm, ↑ 130 cm  
 excl. 1 x E27, max. 60 W

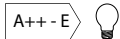

304000106  
 304000115  
 304000142  
 304000151  
 304000192



**00** transparent • transparent  
**06** chrom • chrome  
**15** türkis • turquoise  
**42** anthrazit • anthracite  
**51** apfelgrün • applegreen  
**92** purpurrot • purple



06



15



42



92





## Ratio

Metall • metal •  
 metale • metaal • metal • metallo •  
 metal • metalli • metal • metal



Ø 21 cm, ↑ 135 cm  
 excl. 1 x E27, max. 60 W

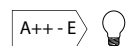

300600101  
 300600102  
 300600187



**01** weiß • white  
**02** schwarz • black  
**87** titanfarbig • titanium-coloured



18

15

19

92

238



Ø 40 cm  
excl. 1 x E27, max. 60 W  
VE / moq; 25



- 3490400-00
- 3490400-15
- 3490400-18
- 3490400-19
- 3490400-92



- 00 weiß • white
- 15 grün • green
- 18 orange • orange
- 19 türkis • turquoise
- 92 lila • lilac



## Paper

Papier • paper •  
 papier • papier • papel • carta •  
 hartie • paperi • papier • kağıt



↓ 73,5 cm  
 excl. 1 x E27, max. 60 W  
 VE / moq: 25

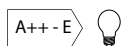

3590010-01



Ø 40 cm, ↓ 47 cm  
 excl. 1 x E27, max. 60 W  
 VE / moq: 25

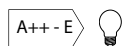

3491400-00



Ø 50 cm  
 excl. 1 x E27, max. 60 W  
 VE / moq: 25

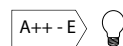

3490500-00



Ø 60 cm  
 excl. 1 x E27, max. 60 W  
 VE / moq: 25

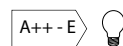

3490600-00







## Spotserien

Spots

Spotterie

Spots

Focos

Faretti

Spoturi

Spotit

Reflektorki

Spotlar



↔ 12 x 12 cm, ↗ 20 cm  
incl. 1 x SMD, 4,3 W  
400 lm, 3.000 K

A+

871910106



↔ 36,5 x 8,5 cm, ↑ 21 cm  
incl. 2 x SMD, 4,3 W  
2 x 400 lm, 3.000 K

A+

871910206



↔ 52,5 x 9,5 cm, ↑ 21 cm  
incl. 3 x SMD, 4,3 W  
3 x 400 lm, 3.000 K

A+

871910306



↔ 83,5 x 9,5 cm, ↑ 21 cm  
incl. 4 x SMD, 4,3 W  
4 x 400 lm, 3.000 K

A+

871910406



↔ 180 x 8,5 cm, ↑ 22 cm  
incl. 6 x SMD, 4,3 W  
6 x 400 lm, 3.000 K

A+

871910606





## Paradox

Aluminium gebürstet, chrom, Acryl • brushed aluminium, chrome, acryl •  
 aluminium balayé, chrome, acryl • geborsteld aluminium, chroom, acryl •  
 aluminio pulido, cromo, acrílico • alluminio spazzolato, cromo, acrílico •  
 aluminiu lucios, crom, acrilic • harjattu alumiini, kromi, akryyli •  
 aluminium szczotkowane, chrom, akryl • alüminyum, krom, akrilik



↔ 30 x 30 cm, ↑ 20 cm  
 incl. 4 x SMD, 4,3 W  
 4 x 400 lm, 3.000 K

A+

671930406

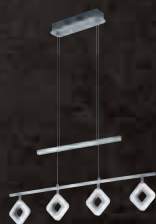

↔ 80 cm, ↑ 95 - 150 cm  
 incl. 4 x SMD, 4,3 W  
 4 x 400 lm, 3.000 K

A+ ↑ ↓

371910406

# Cancun

chrom, Acryl • chrome, acryl •  
chrome, acryl • chroom, acryl • cromo, acrílico • cromo, acrílico •  
crom, acrílic • kromi, akryyli • chrom, akryl • krom, akrilik



↔ 42 cm, ↗ 16 cm  
incl. 3 x SMD, 4,5 W  
3 x 400 lm, 3.000 K



877970306



↔ 73 cm, ↓ 16 cm  
incl. 5 x SMD, 4,5 W  
5 x 400 lm, 3.000 K



877910506



↔ 157 cm, ↓ 19 cm  
incl. 7 x SMD, 4,5 W  
7 x 400 lm, 3.000 K



877910706



↔ 230 cm, ↓ 19 cm  
incl. 11 x SMD, 3,2 W  
11 x 300 lm, 3.000 K

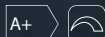

877911106







## Clapton

Aluminium gebürstet, chrom, Glas weiß gewischt •  
 brushed aluminium, chrome, glass white brushed glass •  
 aluminium balayé, chrome, verre blanc balayé • geborsteld aluminium,  
 chroom, wit geborsteld glas • aluminio pulido, cromo, blanco pulido •  
 alluminio spazzolato, cromo, vetro bianco spazzolato • aluminiu lucios,  
 crom, alb lucios • harjattu alumiini, kromi, lasi harjattu valkoinen •  
 aluminium szczotkowane, chrom, szkło białe otařła • alüminyum, krom,  
 beyaz cam



↑ 20 x 7 cm, ↗ 16 cm  
 incl. 1 x SMD, 4,5 W  
 400 lm, 3.000 K



821470105



↔ 36 x 7 cm, ↑ 18,5 cm  
 incl. 2 x SMD, 4,5 W  
 2 x 400 lm, 3.000 K

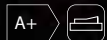

821470205



↔ 50 x 7 cm, ↑ 18,5 cm  
 incl. 3 x SMD, 4,5 W  
 3 x 400 lm, 3.000 K



821410305



↔ 94 x 8 cm, ↑ 18,5 cm  
 incl. 4 x SMD, 4,5 W  
 4 x 400 lm, 3.000 K



821410405



↔ max. 150 x 8 cm, ↑ 24 cm  
 incl. 6 x SMD, 4,5 W  
 6 x 400 lm, 3.000 K



821410605



↔ 23 x 23 cm, ↑ 18,5 cm  
incl. 4 x SMD, 4,5 W  
4 x 400 lm, 3.000 K

A+

821430405



↔ 70 x 50 cm, ↑ 23 cm  
incl. 5 x SMD, 4,5 W  
5 x 400 lm, 3.000 K

A+

621410505





Ø 12 cm, ∅ 16 cm  
incl. 1 x SMD 4,5 W  
400 lm, 3.000 K



874470106



↔ 30 x 8 cm, ∅ 17 cm  
incl. 2 x SMD 4,5 W  
2 x 400 lm, 3.000 K



874470206



↔ 44 x 8 cm, ∅ 17 cm  
incl. 3 x SMD 4,5 W  
3 x 400 lm, 3.000 K



874410306

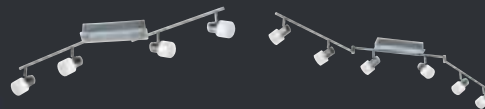

↔ 94 x 8 cm, ∅ 20 cm  
incl. 4 x SMD 4,5 W  
4 x 400 lm, 3.000 K



874410406



↔ 150 x 8 cm, ∅ 22 cm  
incl. 6 x SMD 4,5 W  
6 x 400 lm, 3.000 K



874410606



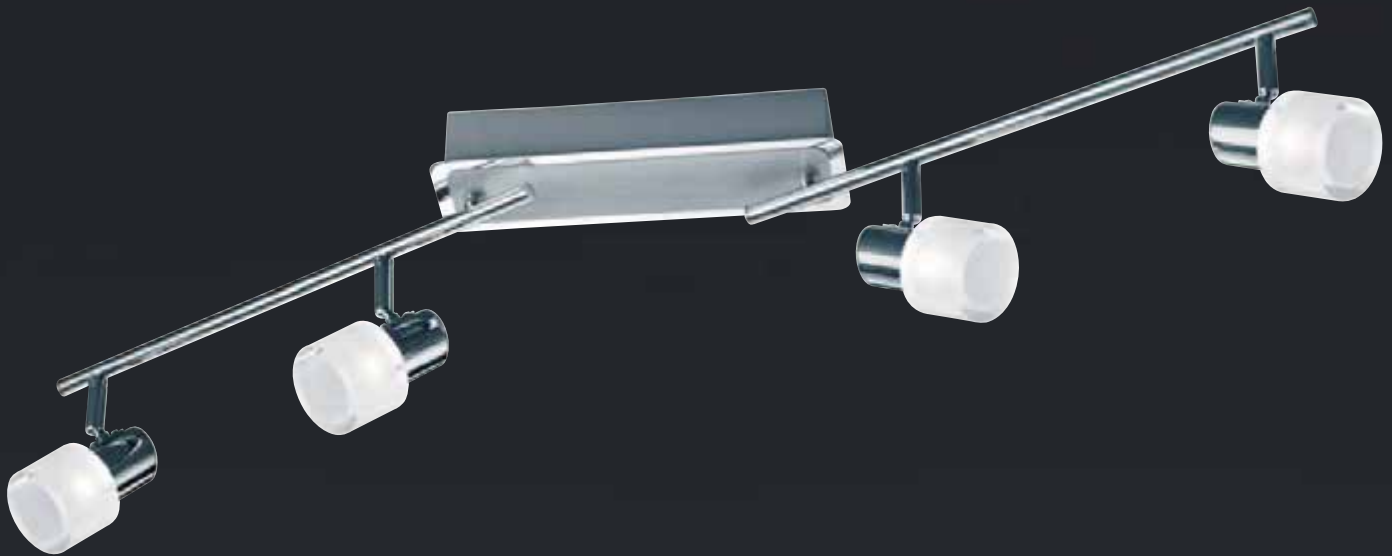

## Presley

chrom, Aluminium gebürstet, Acryl • chrome, brushed aluminium, acryl •  
 chrome, aluminium balayé, acryl • chroom, geborsteld aluminium, acryl •  
 cromo, aluminio pulido, acrílico • cromo, alluminio spazzolato, acrilico •  
 crom, aluminiu lucios, acrilic • kromi, harjattu alumiini, akryyli •  
 chrom, aluminium szczotkowane, akryl • krom, alüminyum, akrilik



↔ 72 x 50 cm, ↓ 17 cm  
 incl. 5 x SMD 4,5 W  
 5 x 400 lm, 3.000 K

A+

674410506

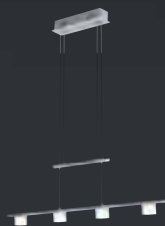

↔ 90 cm, ↓ 90 - 140 cm  
 incl. 4 x SMD 4,5 W  
 4 x 400 lm, 3.000 K

A+



374410406



## Havana

Nickel matt • matt nickel •  
 Nichel mat • Mat nikel • Nikiel mat • Harjattu teräs •  
 Níquel mate • Nichel opaco • Nickel mat • Nikkel mat



↔ 10 x 18 cm, ↑ 16 cm  
 incl. 1 x SMD, 6 W  
 1 x 470 lm, 3.000 K



**829910107**

C 829910107 Smart control



↔ 26 x 20 cm, ↑ 16 cm  
 incl. 2 x SMD, 6 W  
 2 x 470 lm, 3.000 K



**829910207**

C 829910207 Smart control



↔ 34 x 20 cm, ↑ 16 cm  
 incl. 3 x SMD, 6 W  
 3 x 470 lm, 3.000 K



**829910307**

C 829910307 Smart control



↔ 42 x 20 cm, ↑ 16 cm  
 incl. 4 x SMD, 6 W  
 4 x 470 lm, 3.000 K



**829910407**

C 829910407 Smart control



07



## Cayman

Nickel matt oder weiß • matt nickel or white •  
 nickel mat ou blanc • nikkell mat of wit • níquel mate o blanco • nichel opaco o bianco •  
 nichel mat sau alb • harjattu teräs tai valkoinen • nikiel mat lub biały • mat nikel veya beyaz



252



↔ 8,5 x 8,5 cm, ↗ 12,5 cm  
 incl. 1 x SMD, 4,5 W  
 1 x 430 lm, 3.000 K



829270101  
 829270107



↔ 22 x 9 cm, ↑ 12,5 cm  
 incl. 2 x SMD, 4,5 W  
 2 x 430 lm, 3.000 K



829210201  
 829210207



↔ 36 x 9 cm, ↑ 12,5 cm  
 incl. 3 x SMD, 4,5 W  
 3 x 430 lm, 3.000 K



829210301  
 829210307



↔ 21 x 21 cm, ↑ 12,4 cm  
 incl. 4 x SMD, 4,5 W  
 4 x 430 lm, 3.000 K



829230401  
 829230407



↔ 84 x 9 cm, ↑ 15 cm  
 incl. 4 x SMD, 4,5 W  
 4 x 430 lm, 3.000 K



829210401  
 829210407



**01** weiß • white  
**07** nickel matt • nickel mat



01



07



01



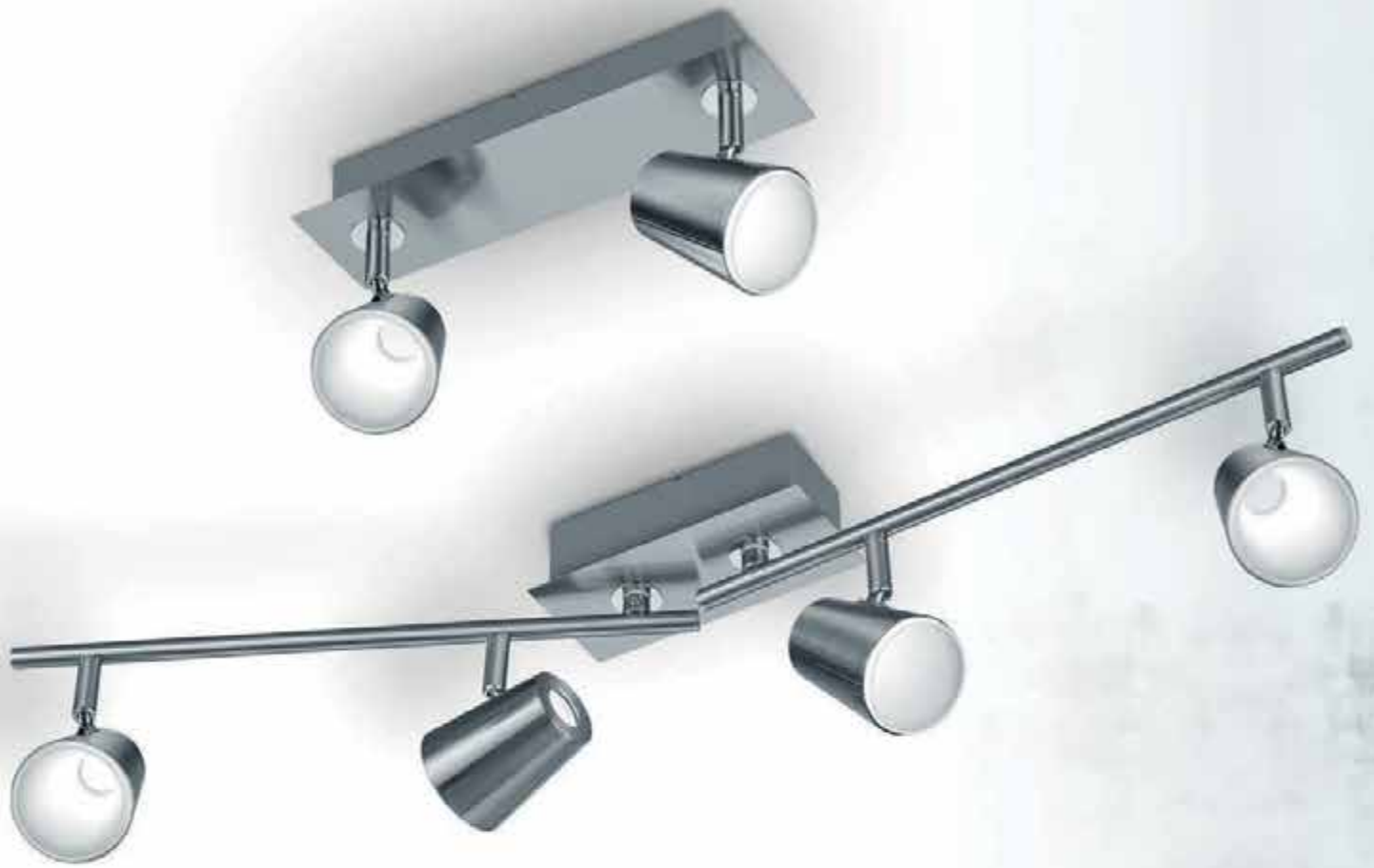

# Narcos

Nickel matt • nickel mat •  
 nickel mat • nikkell mat • níquel mate • nichel opaco •  
 nichel mat • harjattu teräs • nikiel mat • mat nikel



↔ 7,5, ↑ 12 cm, ↗ 16 cm  
 incl. SMD, 6 W  
 550 lm, 3.000 K



873170107



↔ 28,5, ↑ 9,5 cm, ↗ 16 cm  
 incl. 2 x SMD, 6 W  
 2 x 550 lm, 3.000 K



873170207



↔ 45, ↑ 9,5 cm, ↑ 16 cm  
 incl. 3 x SMD, 6 W  
 3 x 550 lm, 3.000 K



873110307



↔ 81,5 x 8 cm, ↑ 20 cm  
 incl. 4 x SMD, 6 W  
 4 x 550 lm, 3.000 K



873110407



↔ 177 x 10 cm, ↑ 23 cm  
 incl. 6 x SMD, 6 W  
 6 x 550 lm, 3.000 K



873110607



↑ 38 cm  
 incl. SMD, 4,7 W  
 470 lm, 3.000 K



573190107

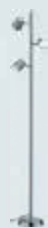

↔ 28 x 18 cm, ↑ 154 cm  
incl. 3 x SMD, 4,7 W  
3 x 470 lm, 3.000 K



473190307



## Narcos

weiß matt • white mat •  
 blanc mat • wit mat • blanco mate • bianco opaco •  
 alb mat • valkoinen teräs • biały mat • mat beyaz



↔ 7,5 x 12 cm, ↗ 16 cm  
 incl. SMD, 6 W  
 550 lm, 3.000 K



873170131



↔ 28,5 x 9,5 cm, ↗ 16 cm  
 incl. 2 x SMD, 6 W  
 2 x 550 lm, 3.000 K



873170231



↔ 45 x 9,5 cm, ↑ 16 cm  
 incl. 3 x SMD, 6 W  
 3 x 550 lm, 3.000 K



873110331



↔ 81,5 x 8 cm, ↑ 20 cm  
 incl. 4 x SMD, 6 W  
 4 x 550 lm, 3.000 K

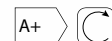

873110431



↔ 177 x 10 cm, ↑ 23 cm  
 incl. 6 x SMD, 6 W  
 6 x 550 lm, 3.000 K



873110631



↑ 38 cm  
 incl. SMD, 4,7 W  
 470 lm, 3.000 K

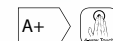

573190131





↔ 28 x 18 cm, ↑ 154 cm  
incl. 3 x SMD, 4,7 W  
3 x 470 lm, 3.000 K



473190331



## Cartney

Aluminium gebürstet • brushed aluminium •  
aluminium balayé • geborsteld aluminium • aluminio pulido •  
alluminio spazzolato • aluminium lucios • harjattu alumiini •  
aluminium szczotkowane • alüminyum



Ø 10,5 cm, ℓ 14 cm  
incl. 1 x SMD, 3,6 W  
350 lm, 3.000 K



829370105



↔ 36 x 8,5 cm, ℓ 14 cm  
incl. 2 x SMD, 3,6 W  
2 x 350 lm, 3.000 K



829370205



↔ 46 x 8,5 cm, ↑ 14 cm  
incl. 3 x SMD, 3,6 W  
3 x 350 lm, 3.000 K



829310305



↔ 83 x 8,5 cm, ↑ 16,5 cm  
incl. 4 x SMD, 3,6 W  
4 x 350 lm, 3.000 K

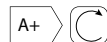

829310405



↔ 150 x 8,5 cm, ↑ 19 cm  
incl. 6 x SMD, 3,6 W  
6 x 350 lm, 3.000 K



829310605

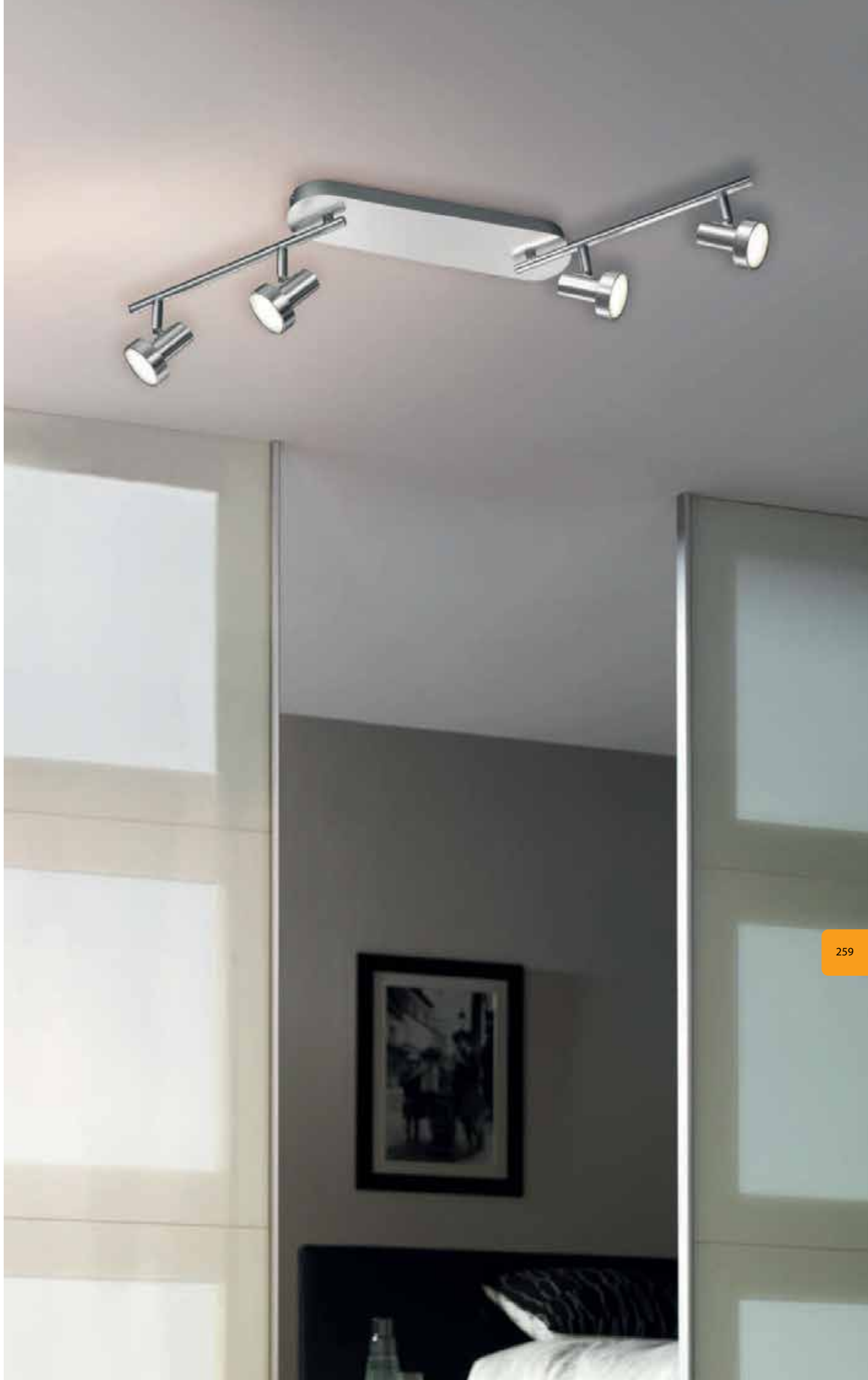



## Techno

chrom, Glas matt • chrome, mat glass •  
 chrome, verre mat • chrom, mat glas • cromo, vidrio mate •  
 cromo, vetro sabbaiato • crom, sticla mata • kromi, mattalasi •  
 chrom, szkło matowane • krom, mat cam



↓ 13,5 x 7,5 cm, ↗ 15,5 cm  
 incl. 1 x SMD, 4,5 W  
 400 lm, 3.000 K



878770106



↔ 32 x 7,5 cm, ↑ 15,5 cm  
 incl. 2 x SMD, 4,5 W  
 2 x 400 lm, 3.000 K



878710206



↔ 55 x 7,5 cm, ↑ 15,5 cm  
 incl. 3 x SMD, 4,5 W  
 3 x 400 lm, 3.000 K



878710306



↔ 82,5 x 7,5 cm, ↑ 20 cm  
 incl. 4 x SMD, 4,5 W  
 4 x 400 lm, 3.000 K



878710406



↔ 180 x 7,5 cm, ↑ 20 cm  
 incl. 6 x SMD, 4,5 W  
 6 x 400 lm, 3.000 K



878710606





↓ 45 cm, Ø 16 cm  
incl. 1 x SMD, 4,5 W  
400 lm, 3.000 K



578710106



↓ 150 cm, Ø 21 cm  
incl. 3 x SMD, 4,5 W  
3 x 400 lm, 3.000 K



478710306

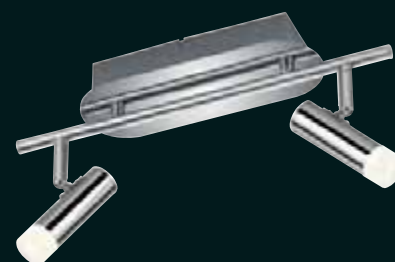

# Zidane

chrom, Acryl • chrome, acryl •  
 chrome, acryl • chrom, acryl • cromo, acrílico •  
 cromo, acrílico • crom, acrílic • kromi, akryyli •  
 chrom, akryl • krom, akrilik



↑ 14 x 8 cm, ↗ 15 cm  
 incl. 1 x SMD, 4,5 W  
 430 lm, 3.000 K



878670106



↔ 34 x 12 cm, ↑ 17,5 cm  
 incl. 2 x SMD, 4,5 W  
 2 x 430 lm, 3.000 K



878610206



↔ 60 x 12 cm, ↑ 17,5 cm  
 incl. 3 x SMD, 4,5 W  
 3 x 430 lm, 3.000 K



878610306

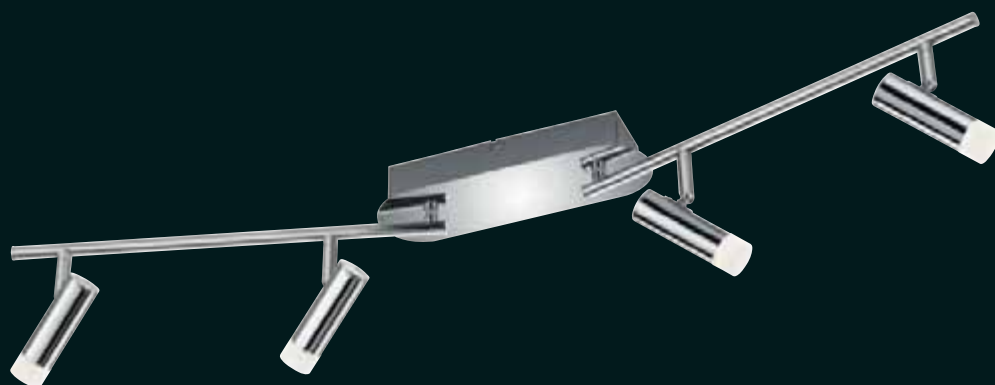

↔ 90 x 12 cm, ↑ 18 cm  
incl. 4 x SMD, 4,5 W  
4 x 430 lm, 3.000 K



878610406



↔ 180 x 12 cm, ↑ 20 cm  
incl. 6 x SMD, 4,5 W  
6 x 430 lm, 3.000 K



878610606



↑ 45 cm, ↔ 16,5 cm  
incl. 2 x SMD, 4,5 W  
2 x 430 lm, 3.000 K



578610206



↑ 145 cm, ↔ 24 cm  
incl. 3 x SMD, 4,5 W  
3 x 430 lm, 3.000 K



478610306



Ø 35 cm, ↑ 13,5 cm  
incl. 5 x SMD, 4,5 W  
5 x 430 lm, 3.000 K



678610506  
C 678610506 Smart control



# Madrid

chrom, Kunststoff • chrome, plastic •  
 chrome, plastique • chrom, kunststof • cromo, plástico • cromo, plastica •  
 crom, plastic • kromi, muovi • chrom, plastik • krom, plastik



Getrennt schaltbar • separately switchable •  
 interrupteurs séparés • gescheiden schakelbaar •  
 interruptores separados • interruttori separati •  
 intreruptoare separate • erikseen kytkettävissä •  
 oddzileny przełącznik • dışarıdan anahtarlı

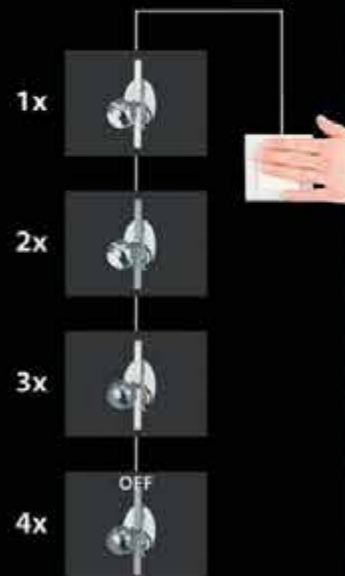

↔ 25 cm, ↗ 17,8 cm  
 incl. 2 x 4 W  
 2 x 310 lm, 3.000 K



821770206

↔ 36,5 cm, ↗ 17,8 cm  
 incl. 2 x 4 W, 2 x 310 lm  
 incl. 1 x 5,5 W, 1 x 430 lm  
 3.000 K



821770306

↔ 48 x 9,5 cm, ↑ 17,8 cm  
 incl. 3 x 4 W, 3 x 310 lm  
 incl. 1 x 6 W, 1 x 500 lm  
 3.000 K



821710406

↔ 70 x 9,5 cm, ↑ 17,8 cm  
 incl. 4 x 4 W, 4 x 310 lm  
 incl. 2 x 5,5 W, 2 x 430 lm  
 3.000 K



821710606





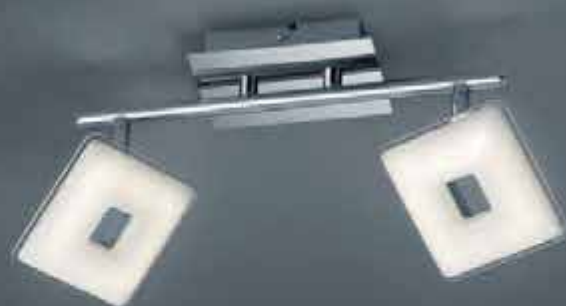
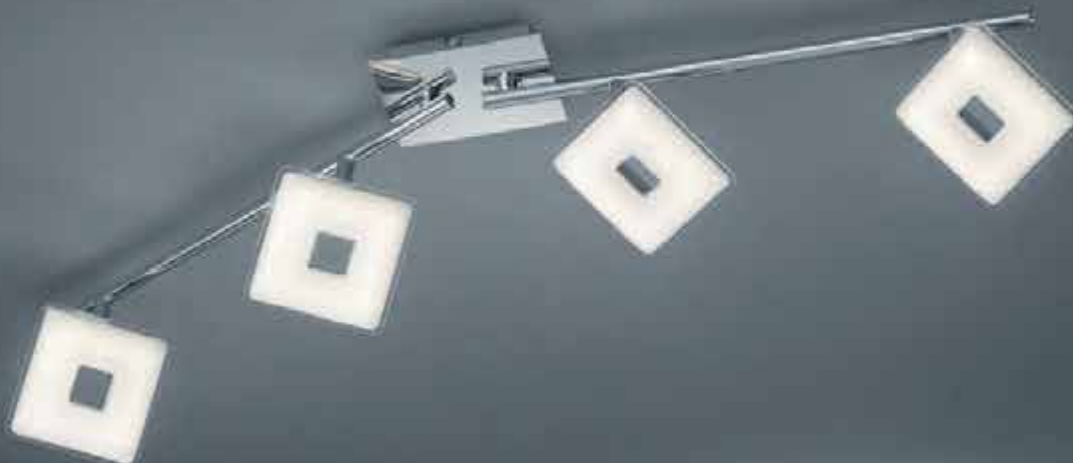

## Pontius

chrom, Acryl • chrome, acryl •  
chrome, acryl • chroom, acryl • cromo, acrílico •  
cromo, acrílico • crom, acrílic • kromi, akryyli •  
chrom, akryl • krom, akrilik



↔ 10,8 x 11,5 cm, ↗ 11,5 cm  
incl. 1 x SMD, 3,8 W  
330 lm, 3.000 K



875810106



↔ 30,5 x 10,8 cm, ↑ 16 cm  
incl. 2 x SMD, 3,8 W  
2 x 330 lm, 3.000 K



875810206



↔ 48,5 x 10,8 cm, ↑ 16 cm  
incl. 3 x SMD, 3,8 W  
3 x 330 lm, 3.000 K



875810306



↔ 83,5 x 10,8 cm, ↑ 16 cm  
incl. 4 x SMD, 3,8 W  
4 x 330 lm, 3.000 K



875810406



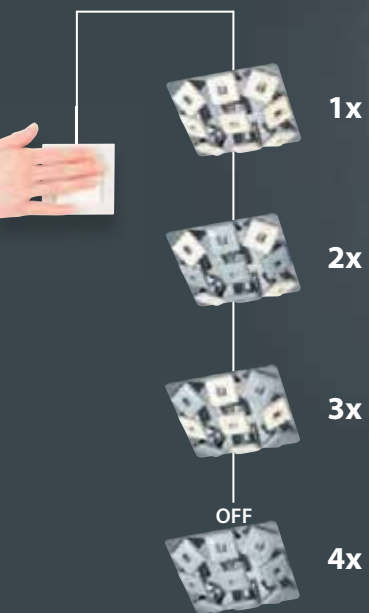

↔ 177 x 10,8 cm, ↑ 18 cm  
incl. 6 x SMD, 3,8 W  
6 x 330 lm, 3.000 K



875810606



↔ 27,5 x 27,5 cm, ↑ 9 cm  
incl. 4 x SMD, 3,8 W  
4 x 330 lm, 3.000 K



675810406



↔ 40 x 40 cm, ↑ 9 cm  
incl. 9 x SMD, 3,8 W  
9 x 330 lm, 3.000 K

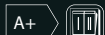

675810906

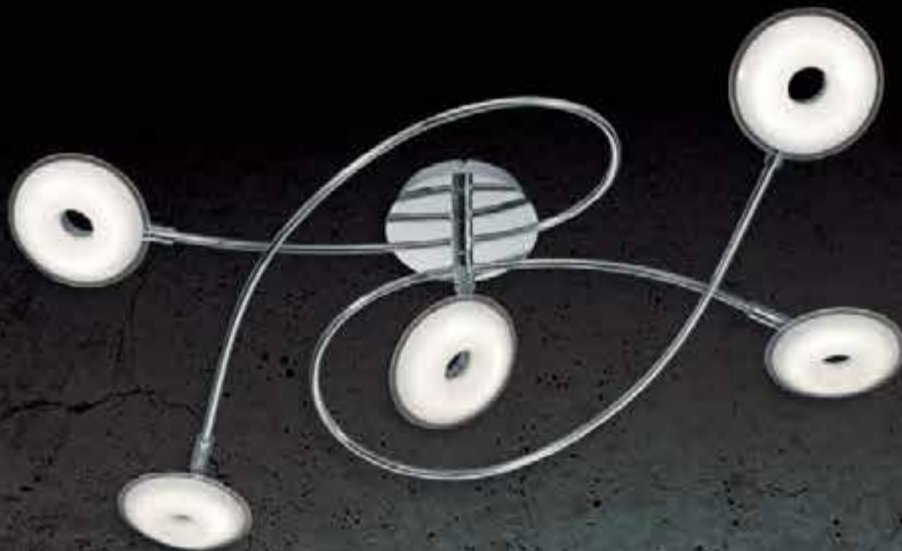

## Pilatus

chrom, Acryl • chrome, acryl •  
chrome, acryl • chroom, acryl • cromo, acrílico •  
cromo, acrílico • crom, acrílic • kromi, akryyli •  
chrom, akryl • krom, akrilik



Ø 11 cm, ↗ 14 cm  
incl. 1 x SMD, 3,8 W  
350 lm, 3.000 K

A+

875910106



↔ 34 cm, ↑ 16 cm  
incl. 2 x SMD, 3,8 W  
2 x 350 lm, 3.000 K

A+

875910206



↔ 89 cm, ↑ 16 cm  
incl. 4 x SMD, 3,8 W  
4 x 350 lm, 3.000 K

A+

875910406



↔ 180 cm, ↑ 16 cm  
incl. 6 x SMD, 3,8 W  
6 x 350 lm, 3.000 K

A+

875910606



Ø 25 cm, ↑ 16 cm  
incl. 3 x SMD, 3,8 W  
3 x 350 lm, 3.000 K

A+

875990306



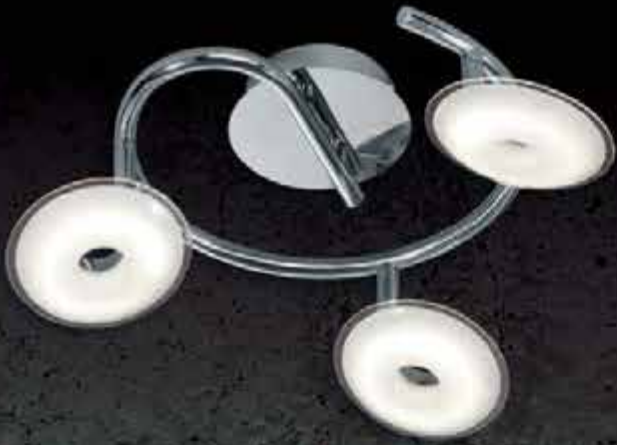

↔ 74 x 38 cm, ↑ 18,5 cm  
incl. 5 x SMD, 3,8 W  
5 x 350 lm, 3.000 K

A+

675910506

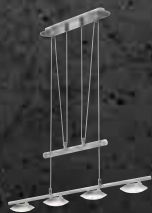

↔ 80 cm, ↑ 95 - 160 cm  
incl. 4 x SMD, 3,8 W  
4 x 350 lm, 3.000 K

A+



375910406







## Pontius

chrom, Acryl • chrome, acryl •  
 chrome, acryl • chroom, acryl • cromo, acrílico •  
 cromo, acrílico • crom, acrílic • kromi, akryyli •  
 chrom, akryl • krom, akrilik



## Pilatus

chrom, Acryl • chrome, acryl •  
 chrome, acryl • chroom, acryl • cromo, acrílico •  
 cromo, acrílico • crom, acrílic • kromi, akryyli •  
 chrom, akryl • krom, akrilik



↔ max. 500 x 13,5 cm, ↑ 15 cm  
 incl. 5 x SMD, 4,1 W  
 5 x 330 lm, 3.000 K

A+

775810506



↔ max. 500 x 13 cm, ↑ 15 cm  
 incl. 5 x SMD, 3,8 W  
 5 x 350 lm, 3.000 K

A+

775910506



272

## Avignon

chrom, Acryl • chrome, acryl •  
chrome, acryl • chroom, acryl • cromo, acrílico •  
cromo, acrílico • crom, acrílic • kromi, akryyli •  
chrom, akryl • krom, akrilik



↔ max. 500 x 13 cm, ↑ 11 cm  
incl. 5 x SMD, 4,1 W  
5 x 330 lm, 3.000 K



777710506





## Rennes

chrom, Acryl • chrome, acryl •  
 chrome, acryl • chroom, acryl • cromo, acrílico •  
 cromo, acrilico • crom, acrilic • kromi, akryyli •  
 chrom, akryl • krom, akrilik



## Basic

titanfarbig • titan •  
 titane • titaan • titán • titano •  
 titaniu • titaani • tytanowy • titan



LED GU5,3/MR16, 3 W  
 260 lm, 3.000 K  
 25.000 h

A+

916-30



## Baloubet

chrom, Acryl • chrome, acryl •  
 chrome, acryl • chroom, acryl • cromo, acrílico •  
 cromo, acrilico • crom, acrilic • kromi, akryyli •  
 chrom, akryl • krom, akrilik



↔ max. 500 x 11 cm, ↑ 17 cm  
 incl. 5 x SMD, 3,8 W  
 5 x 350 lm, 3.000 K

A+

774110506



↔ max. 500 x 8 cm, ↑ 28 cm  
 incl. 5 x LED GU5,3/MR16, 3 W  
 5 x 260 lm, 3.000 K

A+

770010587



↔ max. 500 x 11 cm, ↑ 15,7 cm  
 incl. 5 x SMD, 3,8 W  
 5 x 350 lm, 3.100 K

A+

778210506

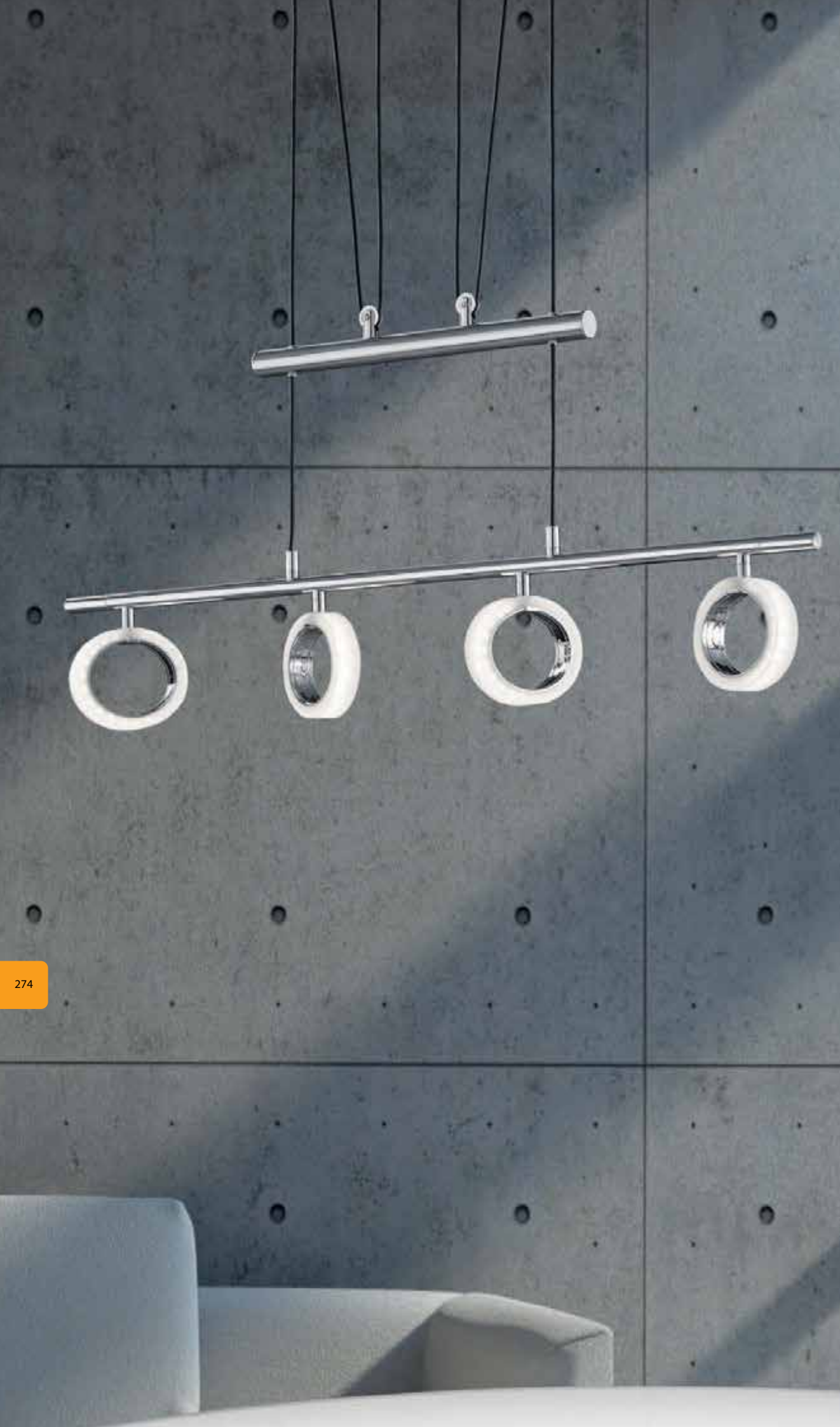

↔ 11 x 8 cm, ∅ 15 cm  
incl. 1 x SMD, 3,5 W  
370 lm, 3.000 K



874210106



## Corland II

chrom, Acryl • chrome, acryl •  
 chrome, acryl • chroom, acryl • cromo, acrílico •  
 cromo, acrílico • crom, acrílic • kromi, akryyli •  
 chrom, akryl • krom, akrilik



↔ 30 cm, ↑ 18 cm  
 incl. 2 x SMD, 3,5 W  
 2 x 370 lm, 3.000 K



874210206



↔ 42 cm, ↑ 18 cm  
 incl. 3 x SMD, 3,5 W  
 3 x 370 lm, 3.000 K



874210306



↔ 85 cm, ↑ 18 cm  
 incl. 4 x SMD, 3,5 W  
 4 x 370 lm, 3.000 K



874210406



↔ max. 180 cm, ↑ 20 cm  
 incl. 6 x SMD, 3,5 W  
 6 x 370 lm, 3.000 K



874210606



↔ 75,5 x 41 cm, ↑ 21 cm  
 incl. 5 x SMD, 3,5 W  
 5 x 370 lm, 3.000 K



674210506

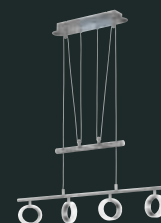

↔ 80 cm, ↑ 85 - 170 cm  
 incl. 4 x SMD, 3,5 W  
 4 x 370 lm, 3.000 K



374210406

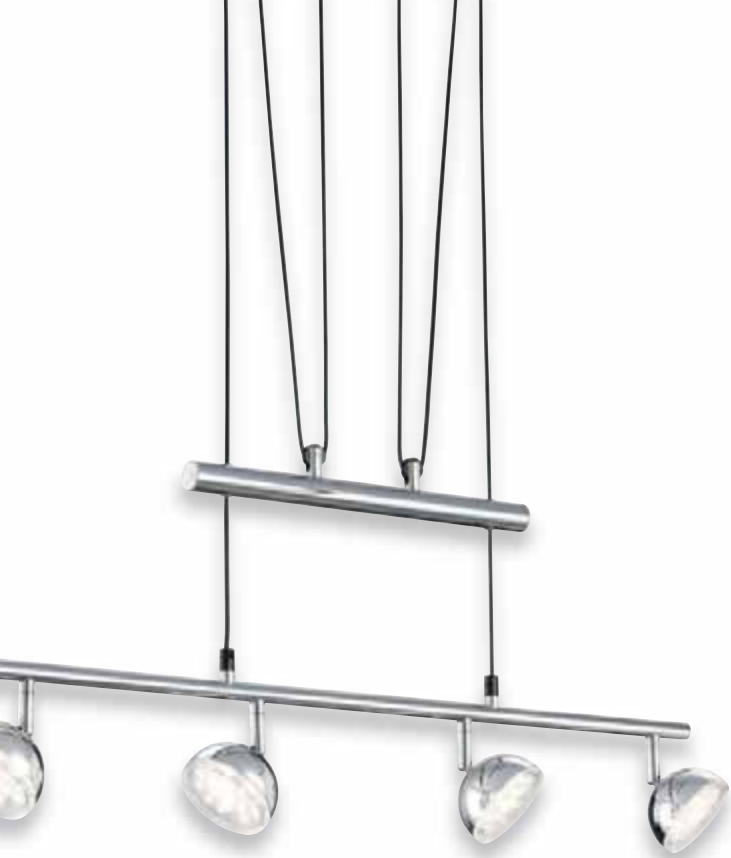

Ø 10 cm, ℓ 13 cm  
incl. 1 x SMD 3,8 W  
350 lm, 3.100 K

A+

872810106



↔ 33,5 cm, ↓ 13 cm  
incl. 2 x SMD 3,8 W  
2 x 350 lm, 3.100 K

A+

872810206



↔ 75 cm, ↓ 13 cm  
incl. 4 x SMD 3,8 W  
4 x 350 lm, 3.100 K

A+

872810406



↔ 150 cm, ↓ 16 cm  
incl. 6 x SMD 3,8 W  
6 x 350 lm, 3.100 K

A+

872810606



Ø 25 cm, ↓ 12 cm  
incl. 3 x SMD 3,8 W  
3 x 350 lm, 3.100 K

A+

872830306



Ø 25 cm, ↓ max. 40 cm  
incl. 5 x SMD 3,8 W  
5 x 350 lm, 3.100 K

A+

672810506





## Bolou

chrom, Kunststoff/Metall • chrome, plastic/metal •  
 chrome, plastique/metale • chroom, kunststof/metaal •  
 cromo, plástico/metal • cromo, plastica/metallo • crom, plastic/metal •  
 kromi, muovi/metalli • chrom, plastik/metal • krom, plastik/metal

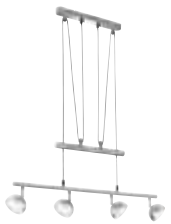

↔ 75 cm, ↓ 80 - 140 cm  
 incl. 4 x SMD 3,8 W  
 4 x 350 lm, 3.100 K



372810406



↔ 100 cm, ↓ 130 cm  
 incl. 5 x SMD 3,8 W  
 5 x 350 lm, 3.100 K



372810506



↓ max. 35 cm, Ø 11,5 cm  
 incl. 1 x SMD 3,8 W  
 350 lm, 3.100 K



572810106



Ø 8 cm, ↓ max. 30 cm  
 incl. 1 x SMD 3,8 W  
 350 lm, 3.100 K



872880106



Ø 10 cm, 13 cm  
incl. 1 x SMD, 3,8 W  
350 lm, 3.100 K



872810101



↔ 33,5 cm, ↑ 13 cm  
incl. 2 x SMD, 3,8 W  
2 x 350 lm, 3.100 K



872810201



↔ 75 cm, ↑ 13 cm  
incl. 4 x SMD, 3,8 W  
4 x 350 lm, 3.100 K



872810401



↔ 150 cm, ↑ 16 cm  
incl. 6 x SMD, 3,8 W  
6 x 350 lm, 3.100 K



872810601



Ø 25 cm, ↑ 12 cm  
incl. 3 x SMD, 3,8 W  
3 x 350 lm, 3.100 K



872830301



Ø 25 cm, ↑ max. 40 cm  
incl. 5 x SMD, 3,8 W  
5 x 350 lm, 3.100 K



672810501



## Bolou

weiß, Kunststoff/Metall • white, plastic/metal •  
 blanc, plastique/métale • wit, kunststof/metaal • blanco, plástico/metal •  
 bianco, plastica/metallo • alb, plastic/metal • valkoinen, muovi/metalli •  
 biały, plastik/metal • beyaz, plastik/metal

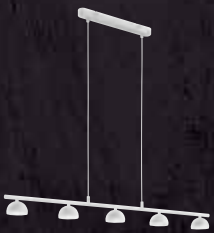

↔ 100 cm, ↑ 130 cm  
 incl. 5 x SMD, 3,8 W  
 5 x 350 lm, 3.100 K

A+

372810501



↓ max. 35 cm, Ø 11,5 cm  
 incl. 1 x SMD, 3,8 W  
 350 lm, 3.100 K

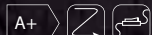

572810101



Ø 8 cm, ↑ max. 30 cm  
 incl. 1 x SMD, 3,8 W  
 350 lm, 3.100 K



872880101





Ø 8 cm, 15 cm  
incl. 1 x SMD, 3,8 W  
350 lm, 3.100 K



828210106



↔ 33,5 cm, ↓ 16,5 cm  
incl. 2 x SMD, 3,8 W  
2 x 350 lm, 3.100 K



828210206



↔ 49,5 cm, ↓ 16,5 cm  
incl. 3 x SMD, 3,8 W  
3 x 350 lm, 3.100 K



828210306



↔ 83 cm, ↓ 16,5 cm  
incl. 4 x SMD, 3,8 W  
4 x 350 lm, 3.100 K



828210406



↔ 180 cm, ↓ 19 cm  
incl. 6 x SMD, 3,8 W  
6 x 350 lm, 3.100 K



828210606



↔ 75 x 45 cm, ↓ 25 cm  
incl. 5 x SMD, 3,8 W  
5 x 350 lm, 3.100 K



628290506





# Baloubet

chrom, Kunststoff/Metall • chrome, plastic/metal •  
 chrome, plastique/metale • chroom, kunststof/metaal •  
 cromo, plástico/metale • cromo, plastica/metale • crom, plastic/metal •  
 kromi, muovi/metalli • chrom, plastik/metal • krom, plastik/metal

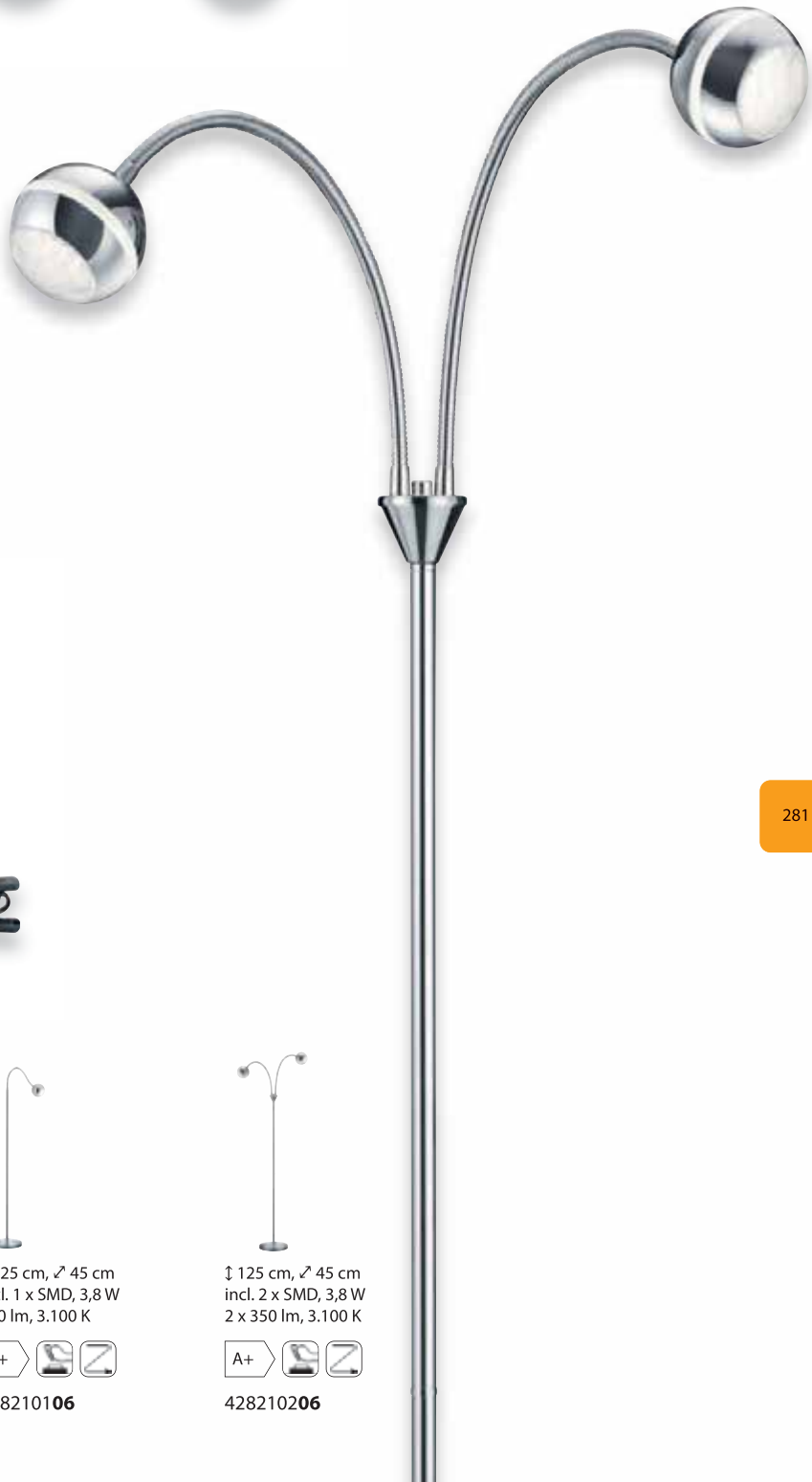

↔ 75 cm, ↑ 79 - 180 cm  
 incl. 4 x SMD, 3,8 W  
 4 x 350 lm, 3.100 K



328210406



↓ 35 cm, ∅ 22 cm  
 incl. 1 x SMD, 3,8 W  
 350 lm, 3.100 K



528210106



↓ max. 44 cm  
 incl. 1 x SMD, 3,8 W  
 350 lm, 3.100 K



828280106



↓ 125 cm, ∅ 45 cm  
 incl. 1 x SMD, 3,8 W  
 350 lm, 3.100 K



428210106



↓ 125 cm, ∅ 45 cm  
 incl. 2 x SMD, 3,8 W  
 2 x 350 lm, 3.100 K



428210206



Ø 8 cm, ↗ 15 cm  
incl. 1 x SMD, 3,8 W  
350 lm, 3.100 K



828210101



↔ 36 cm, ↓ 15 cm  
incl. 2 x SMD, 3,8 W  
2 x 350 lm, 3.100 K



828210201



Ø 21 cm, ↓ 15,5 cm  
incl. 2 x SMD, 3,8 W  
2 x 350 lm, 3.100 K



828230301



↔ 83 cm, ↓ 16,5 cm  
incl. 4 x SMD, 3,8 W  
4 x 350 lm, 3.100 K



828210401



↔ 180 cm, ↓ 19 cm  
incl. 6 x SMD, 3,8 W  
6 x 350 lm, 3.100 K



828210601

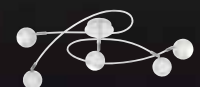

↔ 75 x 45 cm, ↓ 25 cm  
incl. 5 x SMD, 3,8 W  
5 x 350 lm, 3.100 K



628290501



## Baloubet

weiß, Kunststoff/Metall • white, plastic/metal •  
blanc, plastique/métale • wit, kunststof/metaal • blanco, plástico/metal •  
bianco, plastica/metallo • alb, plastic/metal • valkoinen, muovi/metalli •  
biały, plastik/metal • beyaz, plastik/metal



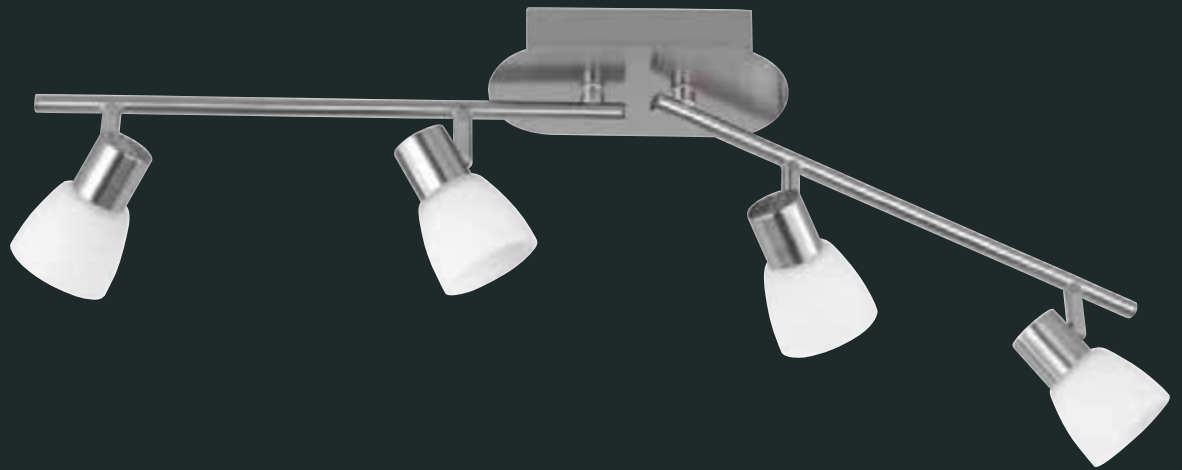

↑ 11 x 7,5 cm, ↗ 16 cm  
incl. 1 x SMD, 4,5 W  
400 lm, 3.000 K

A+

829410107



↔ 32 x 7,5 cm, ↑ 16 cm  
incl. 2 x SMD, 4,5 W  
2 x 400 lm, 3.000 K

A+

829410207



↔ 45 x 7,5 cm, ↑ 16 cm  
incl. 3 x SMD, 4,5 W  
3 x 400 lm, 3.000 K

A+

829410307



↔ 80 x 8 cm, ↑ 21,5 cm  
incl. 4 x SMD, 4,5 W  
4 x 400 lm, 3.000 K

A+

829410407



↔ 184 x 8,5 cm, ↑ 22 cm  
incl. 6 x SMD, 4,5 W  
6 x 400 lm, 3.000 K

A+

829410607



↔ 75 x 37 cm, ↑ 23 cm  
incl. 5 x SMD, 4,5 W  
5 x 400 lm, 3.000 K

A+

629410507



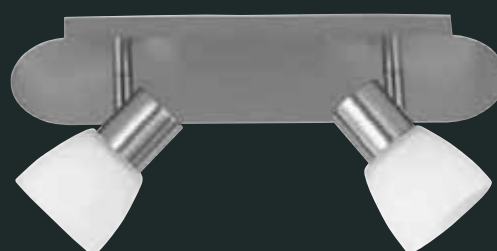
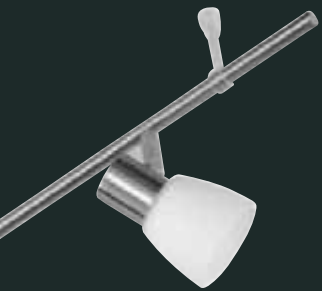

## Charles

Nickel matt, Glas matt • nickel mat, mat glass •  
nickel mat, verre mat • nikkel mat, mat glas •  
níquel mate, vidrio mate • nichel opaco, vetro sabbiato •  
nichel mat, sticla mata • harjattu teräs, mattalasi •  
nikiel mat, szkło matowane • mat nikel, mat cam



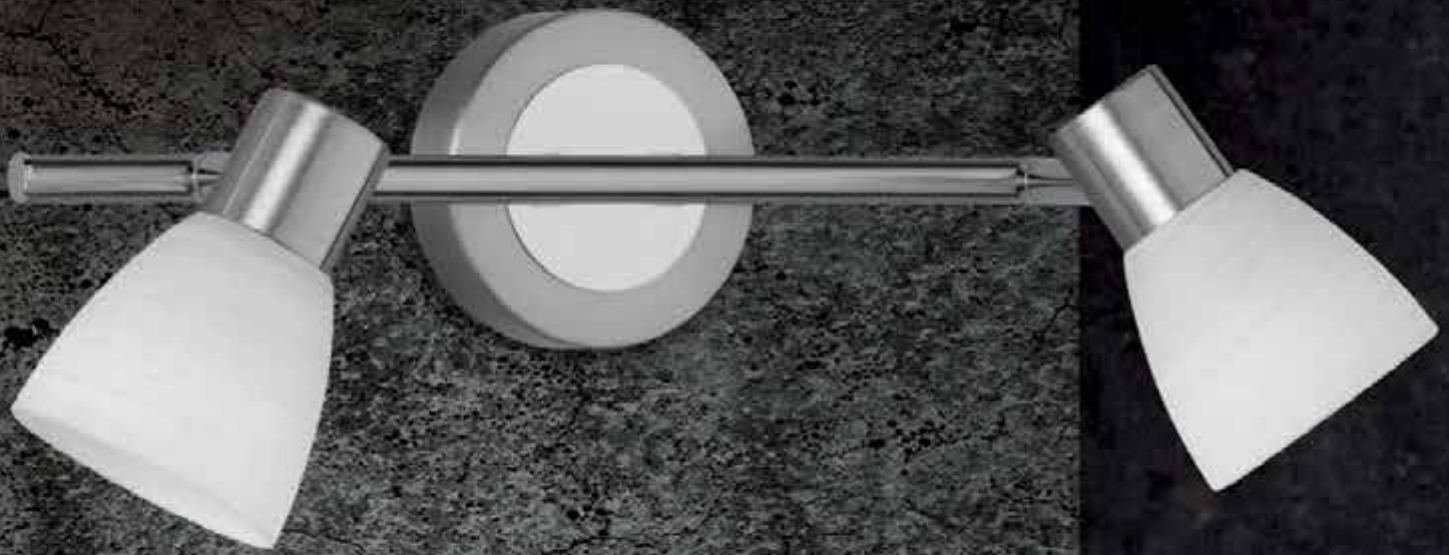

08

07



Ø 9 cm, ↗ 16 cm  
incl. 1 x LED G9, 3,5 W  
300 lm, 3.000 K

↔ 34 cm, ↑ 18 cm  
incl. 2 x LED G9, 3,5 W  
2 x 300 lm, 3.000 K

Ø 29,5 cm, ↑ 18 cm  
incl. 3 x LED G9, 3,5 W  
3 x 300 lm, 3.000 K

↔ 90 cm, ↑ 19 cm  
incl. 4 x LED G9, 3,5 W  
4 x 300 lm, 3.000 K

↔ 150 cm, ↑ 19 cm  
incl. 6 x LED G9, 3,5 W  
6 x 300 lm, 3.000 K



871570107  
871570108

871510207  
871510208

871590307  
871590308

871510407  
871510408

871510607  
871510608





## Carico

Nickel matt oder Messing matt, Glas weiß gewischt • nickel mat or brass mat, glass white brushed glass • nickel mat ou laiton mat, verre blanc balayé • nikkel mat of messing mat, wit geborsteld glas • níquel mate o bronze mate, blanco pulido • nichel opaco o ottone satinato, vetro bianco spazzolato • nichel mat sau bronz mat, alb lucios • harjattu teräs tai mattamessinki, lasi harjattu valkoinen • nikiel mat lub mosiądz mat, szkło białe otarła • mat nikel veya mat pirinç, beyaz cam



incl.  
LED G9, 3,5 W  
300 lm, 3.000 K

A+

929-235



↔ 73 x 34,5 cm, ↑ 21,5 cm  
incl. 5 x LED G9, 3,5 W  
5 x 300 lm, 3.000 K

↔ 74,5 cm, ↑ 95 - 160 cm  
incl. 4 x LED G9, 3,5 W  
4 x 300 lm, 3.000 K



671510507



371510407  
371510408



**07** Nickel matt • matt nickel  
**08** Messing matt • matt brass



## Plucino

Nickel matt, Glas matt • nickel mat, mat glass •  
 nickel mat, verre mat • nikkell mat, mat glas • níquel mate, vidrio mate •  
 nichel opaco, vetro sabbaiato • nichel mat, sticla mata • harjattu teräs, mattalasi •  
 nikiel mat, szkło matowane • mat nikel, mat cam



incl.  
 LED G9, 2,5 W  
 200 lm, 3.000 K

A+



Ø 8 cm, ↗ 16,5 cm  
 incl. 1 x LED G9, 2,5 W  
 200 lm, 3.000 K



876410107



↔ 32 x 8,5 cm, ↓ 18,5 cm  
 incl. 2 x LED G9, 2,5 W  
 3 x 200 lm, 3.000 K  
 incl. 1 x SMD, 3 W  
 300 lm, 3.000 K



876410307



Ø 30 cm, ↓ 17,5 cm  
 incl. 3 x LED G9, 2,5 W  
 3 x 200 lm, 3.000 K  
 incl. 1 x SMD, 3 W  
 300 lm, 3.000 K



876490407



↔ 98 x 8,5 cm, ↓ 21 cm  
 incl. 4 x LED G9, 2,5 W  
 4 x 200 lm, 3.000 K  
 incl. 1 x SMD, 3 W  
 300 lm, 3.000 K



876410507



↔ 180 x 8,5 cm, ↓ 21 cm  
 incl. 8 x LED G9, 2,5 W  
 8 x 200 lm, 3.000 K  
 incl. 1 x SMD, 3 W  
 300 lm, 3.000 K



876410907







07



08

## Levisto

Nickel matt oder Messing matt, Glas alabasterfarbig •  
 nickel mat or brass mat, alabaster-coloured glass •  
 nickel mat ou laiton mat, verre couleur albâtre •  
 nikkell mat of messing mat, albastkleurig glas •  
 níquel mate o bronze mate, vidrio de color alabastro •  
 nichel opaco o ottone satinato, vetro colore alabastro •  
 nichel mat sau bronz mat, sticla culoare alabastru •  
 harjattu teräs tai mattamessinki, lasi alabasteri väri •  
 nikiel mat lub mosiądz mat, szkło alabaster kolor •  
 mat nikel veya mat pirinç, cam kaymaktaşı rengi



incl.  
 LED E14, 6 W  
 470 lm, 3.000 K

A+

983-60



Ø 10 cm, ↗ 19 cm  
 incl. 1 x LED E14, 6 W  
 470 lm, 3.000 K



871010107  
 871010108



↔ 33 cm, ↓ 19 cm  
 incl. 2 x LED E14, 6 W  
 2 x 470 lm, 3.000 K



871010207  
 871010208



↔ 55 cm, ↓ 19 cm  
 incl. 3 x LED E14, 6 W  
 3 x 470 lm, 3.000 K



871010307  
 871010308



Ø 30 cm, ↓ 21 cm  
 incl. 3 x LED E14, 6 W  
 3 x 470 lm, 3.000 K



871090307  
 871090308



↔ 88 cm, ↓ 19 cm  
 incl. 4 x LED E14, 6 W  
 4 x 470 lm, 3.000 K



871010407  
 871010408



↔ 180 cm, ↓ 21 cm  
 incl. 6 x LED E14, 6 W  
 6 x 470 lm, 3.000 K



871010607  
 871010608



↔ 60,5 cm, I 95 - 160 cm  
incl. 3 x LED E14, 6 W  
3 x 470 lm, 3.000 K



371010307  
371010308



↔ 80,5 cm, I 95 - 160 cm  
incl. 4 x LED E14, 6 W  
4 x 470 lm, 3.000 K



371010407  
371010408



**07** Nickel matt • matt nickel  
**08** Messing matt • matt brass



## Freddy

Nickel matt oder rostfarbig, Glas matt • nickel mat or rusty, mat glass •  
 nickel mat ou rouille, verre mat • nikkell mat of roestkleur, mat glas •  
 níquel mate o óxido, vidrio mate • nichel opaco o ruggine, vetro sabbiato •  
 nichel mat sau ruginiu, sticla mata • harjattu teräs tai rustiikki, mattalasi •  
 nikiel mat lub miedz, szkło matowane • mat nikel veyá pas, mat cam



incl.  
 LED E14, 4 W  
 320 lm, 3.000 K

A+

983-40



↓ 13 x 9 cm, ↗ 19 cm  
 incl. 1 x LED E14, 4 W  
 320 lm, 3.000 K



824810107  
 824810128



↔ 30 cm, ↓ 20,5 cm  
 incl. 2 x LED E14, 4 W  
 2 x 320 lm, 3.000 K



824810207  
 824810228



↔ 45 cm, ↓ 20,5 cm  
 incl. 3 x LED E14, 4 W  
 3 x 320 lm, 3.000 K



824810307  
 824810328



↔ 60 cm, ↓ 20,5 cm  
 incl. 4 x LED E14, 4 W  
 4 x 320 lm, 3.000 K



824810407  
 824810428



↔ 150 cm, ↓ 23 cm  
 incl. 6 x LED E14, 4 W  
 6 x 320 lm, 3.000 K

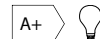

824810607  
 824810628



Ø 52 cm, ↓ 19 cm  
 incl. 3 x LED E14, 4 W  
 3 x 320 lm, 3.000 K



624830307  
 624830328





↑ 40 cm, ↗ 28 cm  
incl. 1 x LED E14, 4 W  
320 lm, 3.000 K



524810107  
524810128



↑ 150 cm, ↗ 55 cm  
incl. 1 x LED E14, 4 W  
320 lm, 3.000 K



424810107  
424810128



↑ 150 cm, ↗ 55 cm  
incl. 2 x LED E14, 4 W  
2 x 320 lm, 3.000 K



424810207  
424810228



↔ 78 cm, ↑ 85 - 180 cm  
incl. 4 x LED E14, 4 W  
4 x 320 lm, 3.000 K



324810407  
324810428



07 Nickel matt • matt nickel  
28 rostfarbig antik • antique rust

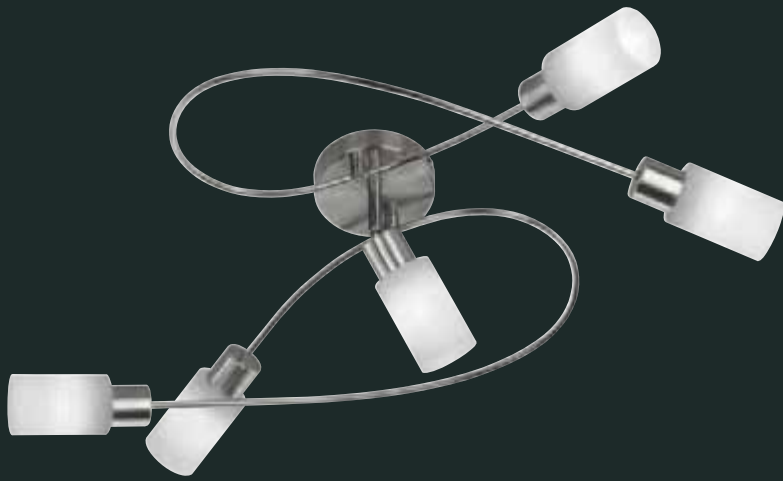

## Jones

Nickel matt, Glas weiß gewischt • nickel mat, glass white brushed glass •  
 nickel mat, verre blanc balayé • nikkell mat, wit geborsteld glas •  
 níquel mate, blanco pulido • nichel opaco, vetro bianco spazzolato •  
 nichel mat, alb lucios • harjattu teräs, lasi harjattu valkoinen •  
 nikiel mat, szkło białe otarła • mat nikel, beyaz cam



incl.  
 LED E14, 4 W  
 320 lm, 3.000 K

A+

989-40



Ø 8 cm, ↗ 18 cm  
 incl. 1 x LED E14, 4 W  
 320 lm, 3.000 K



871410107



↔ 30 cm, ↑ 18 cm  
 incl. 3 x LED E14, 4 W  
 3 x 320 lm, 3.000 K



871410207



↔ 44 cm, ↑ 18 cm  
 incl. 3 x LED E14, 4 W  
 3 x 320 lm, 3.000 K



871410307



↔ 60 cm, ↑ 18 cm  
 incl. 4 x LED E14, 4 W  
 4 x 320 lm, 3.000 K



871410407



↔ 150 cm, ↑ 18 cm  
 incl. 6 x LED E14, 4 W  
 6 x 320 lm, 3.000 K



871410607

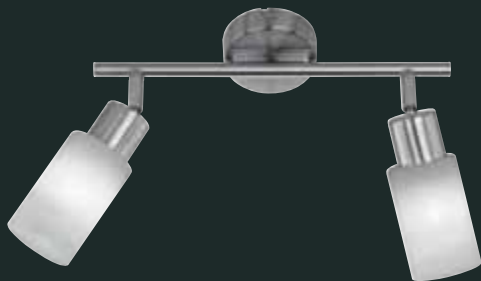

↔ 80 x 48 cm, ↑ 18 cm  
incl. 5 x LED E14, 4 W  
5 x 320 lm, 3.000 K



671410507

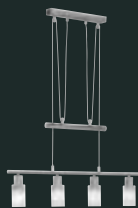

↔ 70 cm, ↑ 77 - 160 cm  
incl. 4 x LED E14, 4 W  
4 x 320 lm, 3.000 K



371410407



## Marlon

Nickel matt, Glas matt • nickel mat, mat glass •  
 nickel mat, verre mat • nikkell mat, mat glas •  
 níquel mate, vidrio mate • nichel opaco, vetro sabbiato •  
 nichel mat, sticla mata • harjattu teräs, mattalasi •  
 nikiel mat, szkło matowane • mat nikel, mat cam

**ECO**  
 HALOGEN



↑ 11 x 8 cm, ↗ 16 cm  
 incl. 1 x G9, 28 W  
 370 lm, 2.800 K



8160211-07



↑ 32 x 8 cm, ↗ 20 cm  
 incl. 1 x G9, 28 W  
 370 lm, 2.800 K



8160911-07



↔ 30 x 6,5 cm, ↑ 17 cm  
 incl. 2 x G9, 28 W  
 2 x 370 lm, 2.800 K



8160221-07



↔ 45 x 6,5 cm, ↑ 17 cm  
 incl. 3 x G9, 28 W  
 3 x 370 lm, 2.800 K



8160031-07





## Dylan

Nickel matt, Glas matt • nickel mat, mat glass •  
 nickel mat, verre mat • nikkell mat, mat glas •  
 níquel mate, vidrio mate • nichel opaco, vetro sabbiato •  
 nichel mat, sticla mata • harjattu teräs, mattalasi •  
 nikiel mat, szkło matowane • mat nikel, mat cam

**ECO** HALOGEN  **LED**



↓ 21 x 12 cm, ↗ 17 cm  
 incl. 1 x G9, 28 W  
 370 lm, 2.800 K  
 incl. 8 x LED 0,06 W (A)  
 4.100 K



821970107



↔ 38 x 12 cm, ↓ 17 cm  
 incl. 2 x G9, 28 W  
 2 x 370 lm, 2.800 K  
 incl. 13 x LED 0,06 W (A)  
 4.100 K



821910207



↔ 56 x 12 cm, ↓ 17 cm  
 incl. 3 x G9, 28 W  
 3 x 370 lm, 2.800 K  
 incl. 20 x LED 0,06 W (A)  
 4.100 K



821910307



↔ 76 x 12 cm, ↓ 17 cm  
 incl. 4 x G9, 28 W  
 4 x 370 lm, 2.800 K  
 incl. 27 x LED 0,06 W (A)  
 4.100 K



821910407



↔ 13 x 9 cm, ↗ 13,5 cm  
incl. 1 x G9, 28 W  
370 lm, 2.800 K



8161011-07



↓ 30 x 9 cm, ↗ 20 cm  
incl. 1 x G9, 18 W  
204 lm, 2.800 K



8161911-07



↔ 31,5 x 9 cm, ↑ 16 cm  
incl. 2 x G9, 28 W  
2 x 370 lm, 2.800 K



8161021-07



## Mercury

chrom, Nickel matt, Glas alabasterfarbig • chrome, nickel mat, alabaster-coloured glass •  
 chrome, nickel mat, verre couleur albâtre • chroom, nikkell mat, albastkleurig glas •  
 cromo, níquel mate, vidrio de color alabastro • cromo, nichel opaco, vetro colore alabastro •  
 crom, nichel mat, sticla culoare alabastru • kromi, harjattu teräs, lasi alabasteri väri •  
 chrom, nikiel mat, szkło alabaster kolor • krom, mat nikel, cam kaymaktaşı rengi

**ECO**  
 HALOGEN



↔ 45,5 x 9,6 cm, ↑ 16 cm  
 incl. 3 x G9, 28 W  
 3 x 370 lm, 2.800 K



8161031-07



↔ 60,5 x 9,6 cm, ↑ 16 cm  
 incl. 4 x G9, 28 W  
 4 x 370 lm, 2.800 K



8161441-07



Ø 25 cm, ↑ 16 cm  
 incl. 3 x G9, 28 W  
 3 x 370 lm, 2.800 K



8161931-07



↔ 155 cm, ↑ 18,5 cm  
 incl. 6 x G9, 28 W  
 6 x 370 lm, 2.800 K



8161061-07



↓ 10,6 x 6 cm, ↗ 13 cm  
incl. 1 x GU10, 50 W  
310 lm, 2.800 K



8130011-07



↓ 37 x 11 cm, ↗ 22 cm  
incl. 1 x GU10, 35 W  
240 lm, 2.800 K



8130911-07



↔ 32 x 5 cm, ↓ 13 cm  
incl. 2 x GU10, 50 W  
2 x 310 lm, 2.800 K



8130021-07



↔ 54 x 5 cm, ↓ 13 cm  
incl. 3 x GU10, 50 W  
3 x 310 lm, 2.800 K

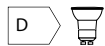

8130031-07



↔ 80 x 10 cm, ↓ 20 cm  
incl. 4 x GU10, 50 W  
4 x 310 lm, 2.800 K



8130441-07



↔ 180 x 10 cm, ↓ 18 cm  
incl. 6 x GU10, 50 W  
6 x 310 lm, 2.800 K



8130061-07





## Jackson

Nickel matt • nickel mat •  
nickel mat • nikkell mat • níquel mate •  
nichel opaco • nichel mat • harjattu teräs •  
nikiel mat • mat nikel



Ø 25,5 cm, ↑ 15 cm  
incl. 3 x GU10, 50 W  
3 x 310 lm, 2.800 K



8130931-07



01

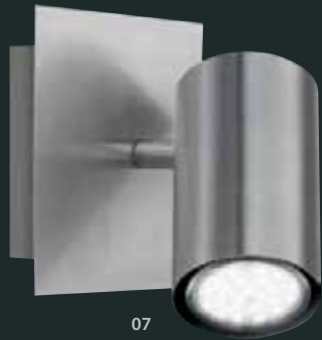

07



↑ 12 x 12 cm, ↗ 15 cm  
excl. 1 x GU10, max. 35 W



802400101  
802400107



↔ 30 x 9 cm, ↑ 15 cm  
excl. 2 x GU10, max. 35 W

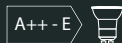

802400201  
802400207

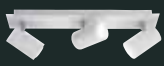

↔ 48 x 9 cm, ↑ 15 cm  
excl. 3 x GU10, max. 35 W

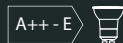

802400301  
802400307



↔ 24 x 24 cm, ↑ 15 cm  
excl. 4 x GU10, max. 35 W

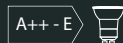

802430401  
802430407



↑ 150 cm, Ø 23 cm  
excl. 2 x GU10, max. 35 W



402400201  
402400207



01 weiß • white  
07 Nickel matt • matt nickel



## Marley

Nickel matt oder weiß • nickel mat or white •  
nickel mat ou blanc • nikkell mat of wit • níquel mate o blanco •  
nichel opaco o bianco • nichel mat sau alb • harjattu teräs tai valkoinen •  
nikiel mat lub biały • mat nikel veya beyaz

Empfohlen:  
recommended:



LED GU10, 5 W  
400 lm, 3.000 K



956-55





## Bowie

chrom • chrome •  
 chrome • chroom • cromo •  
 cromo • crom • kromi • chrom • krom

Empfohlen:  
 recommended:



LED GU10, 5 W  
 400 lm, 3.000 K



**956-55**



↓ 14 x 8 cm, ↗ 15 cm  
 excl. 1 x GU10, max. 25 W



**818070106**



↔ 40 x 8 cm, ↓ 18 cm  
 excl. 2 x GU10, max. 25 W

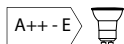

**818000206**



↔ 55 x 8 cm, ↓ 18 cm  
 excl. 3 x GU10, max. 25 W

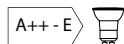

**818000306**



↔ 80 x 8 cm, ↓ 18 cm  
 excl. 4 x GU10, max. 25 W

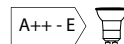

**818000406**



↔ 130 x 8 cm, ↓ 18 cm  
 excl. 6 x GU10, max. 25 W

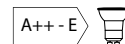

**818000606**





## Morrison

chrom, Glas opal • chrome, opal glass •  
 chrome, verre opale • chrom, opaal glas • cromo, vidrio opal •  
 cromo, vetro opale • crom, sticla opala • kromi, opaalilasi •  
 chrom, szkło opal • krom, opal cam

Empfohlen:  
 recommended:



LED E14, 4 W  
 320 lm, 3.000 K

A+

989-40



Ø 10 cm, 15 cm  
 excl. 1 x E14, max. 40 W

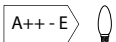

801000106



↔ 35 cm, 17 cm  
 excl. 2 x E14, max. 40 W

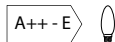

801000206



↔ 50 cm, 17 cm  
 excl. 3 x E14, max. 40 W

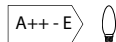

801000306



↔ 92 cm, 17 cm  
 excl. 4 x E14, max. 40 W

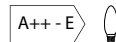

801000406



↔ max. 180 cm, 20 cm  
 excl. 6 x E14, max. 40 W

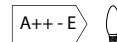

801000606





## Wand- und Deckenleuchten

Wall & Ceiling lamps  
Plafonniers & appliques  
Wandlampen & plafonnières  
Apliques y plafones  
Applique e plafoniere  
Plafoniere si aplice  
Seinä- & katto  
Sufitowe i ścienne  
Tavan & Duvar armatürleri



308

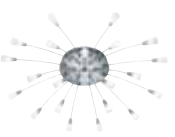

Ø 100 cm, 1 16 cm  
incl. 21 x SMD, 1,1 W  
21 x 115 lm, 3.000 K

A++

628412107

# Miquel

Nickel matt, Glas matt • nickel mat, mat glass •  
nickel mat, verre mat • nikkell mat, mat glas • niqel mate, vidrio mate •  
nichel opaco, vetro sabbato • nichel mat, sticla mata • harjattu teräs,  
mattalasi • nikiel mat, szkło matowane • mat nikel, mat cam







## Umbrella

chrom, Glas matt • chrome, mat glass •  
 chrome, verre mat • chrom, mat glas • cromo, vidrio mate •  
 cromo, vetro sabbaiato • crom, sticla mata • kromi, mattalasi •  
 chrom, szkło matowane • krom, mat cam



Getrennt schaltbar • seperately switchable •  
 interrupteurs séparés • gescheiden schakelbaar •  
 interruptores separados • interruttori separati •  
 intrerupatoare separate • erikseen kytkettävissä •  
 oddzielny przełącznik • dışarıdan anahtarlı

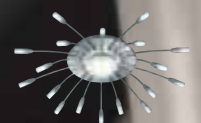

Ø 90 cm, I 16,5 cm  
 incl. 18 x SMD, 1,1 W, A++  
 18 x 115 lm, 3.000 K  
 incl. 2 x SMD, 4,5 W, A+  
 2 x 400 lm, 3.000 K

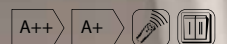

623311806

# Santiago

chrom, Acryl • chrome, acryl •  
chrome, acryl • chroom, acryl • cromo, acrílico • cromo, acrílico •  
crom, acrílic • kromi, akryyli • chrom, akryl • krom, akrilik



310



Ø 80 cm, † 15 cm  
incl. 9 x SMD, 3,2 W  
9 x 300 lm, 3.000 K



678510906  
C678510906 Smart Control





312

## Ruben

chrom, Aluminium gebürstet, Glas weiß gewischt •  
chrome, brushed aluminium, glass white brushed glass •  
chrome, aluminium balayé, verre blanc balayé • chrom, geborsteld aluminium,  
wit geborsteld glas • cromo, aluminio pulido, blanco pulido • cromo, alluminio  
spazzolato, vetro bianco spazzolato • crom, aluminiu lucios, alb lucios • kromi,  
harjattu alumiini, lasi harjattu valkoinen • chrom, aluminium szczotkowane, szkło  
białe otarła • krom, alüminyum, beyaz cam

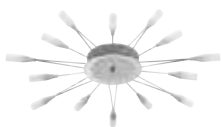

Ø 75 cm, ↑ 7 cm  
incl. 14 x SMD, 1,1 W  
14 x 115 lm, 3.000 K

A++

620711405





## Kowloon

Nickel matt, Acryl • nickel mat, acryl •  
nickel mat, acryl • nikkel mat, acryl • níquel mate, acrílico •  
nichel opaco, acrílico • nichel mat, acrílic • harjattu teräs, akryyli •  
nikiel mat, akryl • mat nikel, akrilik



Ø 35 cm, ↑ 35,5 cm  
incl. SMD, 26 W  
2.700 lm, 3.000 K



675510207  
C675510207 Smart Control



28

314

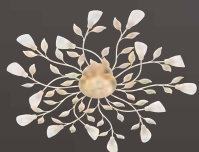

Ø 80 cm, ↑ 10,5 cm  
incl. 15 x SMD, 1 W  
15 x 90 lm, 3.000 K

A++

622811527  
622811528



27 weiß antik • antique white  
28 rostfarbig antik • antique rust



315

## Reposa

weiß antik oder rostfarbig antik, Glas matt • antique white or antique rust, mat glass •  
blanc antique ou rouille antique, verre mat • antiek wit of roestkleur antiek, mat glas • blanco  
decapé o oxido, vidrio mate • bianco anticato o ruggine anticato, vetro sabbato • alb antic sau  
ruginiu antic, sticla mata • antiikkivalkoinen tai rustiikki, mattalasi • antyczny biały lub antyczny  
rdzawy, szkło matowane • antik beyaz veya antik pas rengi, mat cam







89



79

# Vancouver

Glas • glass • verre • glas • vidrio • vetro • sticla • lasi • szkło • cam



316



Ø 50 cm, ↑ 8,5 cm  
incl. SMD, 30 W



656813079  
656813089



Ø 40 cm, ↑ 8,5 cm  
incl. SMD, 20 W



656812079  
656812089



79 goldfarbig • gold  
89 silberfarbig • silver







09



89

## Zenit

Metall, Acryl • metal, acryl •  
 metale, acryl • metaal, acryl • metal, acrílico •  
 metallo, acrilico • metal, acrylic • metalli, akryyli •  
 metal, akryl • metal, akrilik

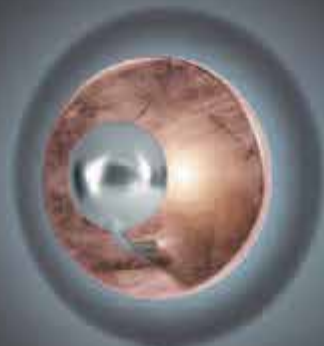

## Aurora

Metall • metal •  
 metale • metaal • metal • metallo •  
 metal • metalli • metal • metal



∇ 12 cm, Ø 20 cm  
 incl. 1 x SMD, 3,2 W, 300 lm  
 incl. 1 x SMD, 3 W, 200 lm  
 3.000 K

↑ max. 50 cm, Ø 36 cm  
 incl. 1 x SMD, 19 W  
 1.700 lm, 3.000 K



223810209  
 223810279  
 223810289

323810109  
 323810179  
 323810189

C 323810109  
 C 323810179  
 C 323810189

09 kupferfarbig • copper  
 79 goldfarbig • gold  
 89 silberfarbig • silver

79



319





## Milano

Glas opal • opal glass  
verre opale • opaal glas • vidrio opal • vetro opale •  
sticla opala • opaalilasi • szkło opal • opal cam



Ø 45 cm, ↑ 11,5 cm  
incl. SMD, 30 W  
2.580 lm, 3.000 K

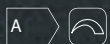

656713001



Ø 36 cm, ↑ 11,5 cm  
incl. SMD, 20 W  
1.720 lm, 3.000 K

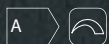

656712001



# Alabaster

Glas alabasterfarbig • alabaster-coloured glass  
verre couleur albâtre • albastkleurig glas • vidrio de color alabastro •  
vetro colore alabastro • sticla culoare alabastru • lasi alabasteri väri •  
szkło alabaster kolor • cam kaymaktaşı rengi



Made in  
Europe

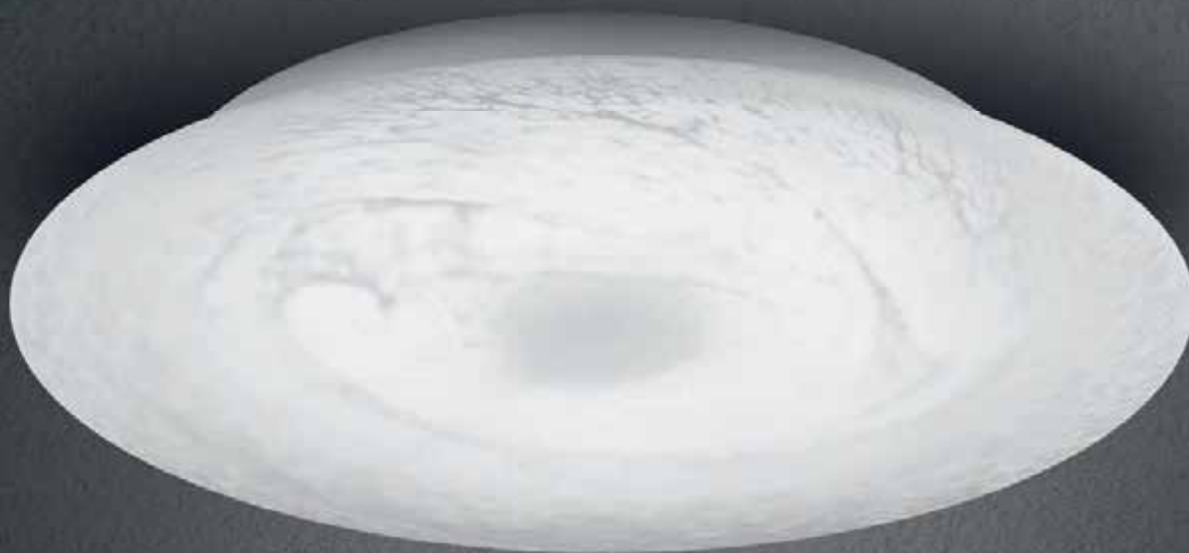

321



Ø 40 cm, ↑ 9,5 cm  
incl. SMD, 30 W  
2.580 lm, 3.000 K



656613001



Ø 32 cm, ↑ 8,5 cm  
incl. SMD, 20 W  
1.720 lm, 3.000 K

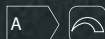

656612001





## Seoul

chrom, Glas satiniert • chrome, satinated glass •  
 chrome, verre satiné • chrom, gesatineerd glas • cromo, vidrio satinado •  
 cromo, vetro satinato • crom, sticla satinata • kromi, satinoitu lasi •  
 chrom, szkło satynowe • krom, satin cam



↔ 42 x 42 cm, ↑ 11 cm  
 incl. 5 x SMD, 4,5 W  
 5 x 400 lm, 3.000 K

A+

623810506



↔ 53 x 34 cm, ↑ 11 cm  
 incl. 4 x SMD, 4,5 W  
 4 x 400 lm, 3.000 K

A+

623810406



↔ 34 x 34 cm, ↑ 11 cm  
 incl. 3 x SMD, 4,5 W  
 3 x 400 lm, 3.000 K

A+

623810306





## Eclipse

chrom, Glas satiniert • chrome, satinated glass •  
chrome, verre satiné • chroom, gesatineerd glas • cromo, vidrio satinado •  
cromo, vetro satinato • crom, sticla satinata • kromi, satinoitu lasi •  
chrom, szkło satynowe • krom, satin cam



323



Ø 35 cm, ↑ 7,5 cm  
incl. 1 x SMD, 12 W  
1.200 lm, 3.500 K



622311206



Ø 24 cm, ↑ 7 cm  
incl. 1 x COB, 5 W  
400 lm, 3.500 K



622310506



∇ 6 cm, Ø 18 cm  
incl. 1 x COB, 3 W  
240 lm, 3.500 K

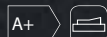

222370306



## Atlanta

Nickel matt, Acryl • nickel mat, acryl •  
 nickel mat, acryl • nikkel mat, acryl • níquel mate, acrílico •  
 nichel opaco, acrílico • nichel mat, acrílic • harjattu teräs, akryyli •  
 nikiel mat, akryl • mat nikel, akrilik



↔ 30 x 30 cm, ↑ 5,5 cm  
 incl. SMD, 22,5 W  
 2.000 lm, 3.000 K



675410107

C 675410107 Smart control



↔ 40 x 40 cm, ↑ 5,6 cm  
 incl. 4 x SMD, 4,3 W  
 4 x 390 lm, 3.000 K



675410407

C 675410407 Smart control



↔ 19 x 19 cm, ↗ 5,1 cm  
 incl. SMD, 4,3 W  
 390 lm, 3.000 K



275470107



↔ 40 x 19 cm, ↗ 5,6 cm  
 incl. 2 x SMD, 4,3 W  
 2 x 390 lm, 3.000 K



275470207



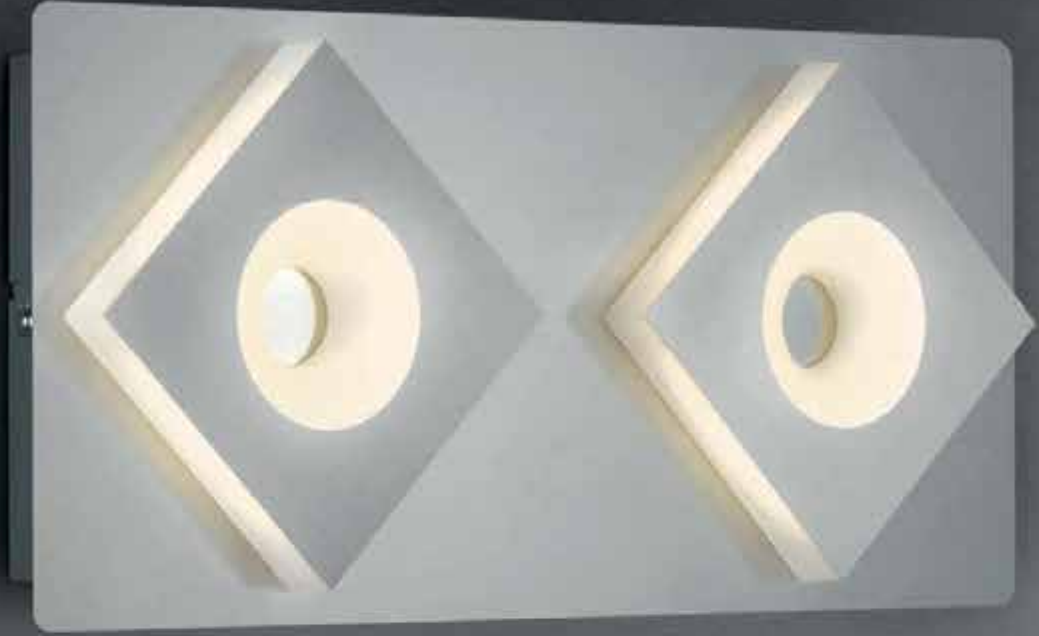



## Dorian

chrom, Acryl • chrome, acryl •  
 chrome, acryl • chroom, acryl • cromo, acrílico • cromo, acrílico •  
 crom, acrílic • kromi, akryyli • chrom, akryl • krom, akrilik



Ø 45 cm, ↑ 32,5 cm  
 incl. SMD, 18 W  
 1.350 lm, 3.000 K



657211806



Ø 35 cm, ↑ 27,5 cm  
 incl. SMD, 12 W  
 900 lm, 3.000 K



657211206



↔ 45 x 45 cm, ↑ 30,5 cm  
 incl. SMD, 18 W  
 1.350 lm, 3.000 K



657311806



↔ 35 x 35 cm, ↑ 26,5 cm  
 incl. SMD, 12 W  
 900 lm, 3.000 K



657311206



## Torino

chrom, Kristallglas • chrome, crystalglass •  
 chrome, cristalverre • chroom, kristalglas • cromo, cristalvidrio • cromo, cristalovetro •  
 crom, cristalsticla • kromi, kristallilasi • chrom, kryształszkło • krom, camkumaş



↑ 8,5 cm, Ø 50 cm  
 incl. SMD, 12,5 W, 1.250 lm,  
 3.000 K



incl. 5 x SMD, 4,5 W, 5 x 450 lm,  
 3.000 K



621513506



↑ 8 cm, Ø 38 cm  
 incl. SMD, 10 W, 900 lm,  
 3.000 K



incl. 5 x SMD, 2,8 W, 5 x 340 lm,  
 3.000 K



621512406



# Antonio

chrom, Glas satiniert • chrome, satinated glass •  
chrome, verre satiné • chrom, gesatineerd glas • cromo, vidrio satinado •  
cromo, vetro satinato • crom, sticla satinata • kromi, satinoitu lasi •  
chrom, szkło satynowe • krom, satin cam



↔ 12 x 12 cm, ↗ 8 cm  
incl. 1 x SMD, 4,5 W  
400 lm, 3.000 K

↔ 26 x 12 cm, ↗ 8 cm  
incl. 2 x SMD, 4,5 W  
2 x 400 lm, 3.000 K

↔ 45 x 12 cm, ↗ 8 cm  
incl. 4 x SMD, 4,5 W  
4 x 400 lm, 3.000 K

↔ 26 x 26 cm, ↑ 8 cm  
incl. 4 x SMD, 4,5 W  
4 x 400 lm, 3.000 K

↔ 38 x 38 cm, ↑ 8 cm  
incl. 5 x SMD, 4,5 W  
5 x 400 lm, 3.000 K

↔ 60 x 60 cm, ↑ 8 cm  
incl. 9 x SMD, 4,5 W  
9 x 400 lm, 3.000 K



227970106

227970206

227970406

627910406

627910506

627910906

C 627910906 Smart Control





## Grandeur

Nickel matt, chrom, Kristallglas • nickel mat, chrome, crystal glass •  
 nickel mat, chrome, verre cristal • nikkel mat, chrom, kristal glas •  
 níquel mate, cromo, vidrio cristal • nichel opaco, cromo, vetro cristallo •  
 nichel mat, crom, sticla cristal • harjattu teräs, kromi, kristallilasi •  
 nikiel mat, chrom, szkło kryształ • mat nikel, krom, kristal cam



↔ 13 x 13 cm, ⌀ 10 cm  
 incl. 1 x SMD, 4,5 W  
 430 lm, 3.000 K



279070107



↔ 32 x 13 cm, ⌀ 10 cm  
 incl. 2 x SMD, 4,5 W  
 2 x 430 lm, 3.000 K



279070207



↔ 50 x 13 cm, ⌀ 10 cm  
 incl. 3 x SMD, 4,5 W  
 3 x 430 lm, 3.000 K

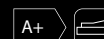

279070307



↔ 35 x 35 cm, ⌀ 10 cm  
 incl. 4 x SMD, 4,5 W  
 4 x 430 lm, 3.000 K



679010407



## Dario

chrom, Glas satiniert • chrome, satinated glass •  
chrome, verre satiné • chroom, gesatineerd glas • cromo, vidrio satinado •  
cromo, vetro satinato • crom, sticla satinata • kromi, satinoitu lasi •  
chrom, szkło satynowe • krom, satin cam



↔ 55 x 9 cm, ↑ 18 cm  
incl. 3 x SMD, 4,5 W  
3 x 400 lm, 3.000 K

A+

628910306



↔ 80 x 9 cm, ↑ 18 cm  
incl. 4 x SMD, 4,5 W  
4 x 400 lm, 3.000 K

A+

628910406

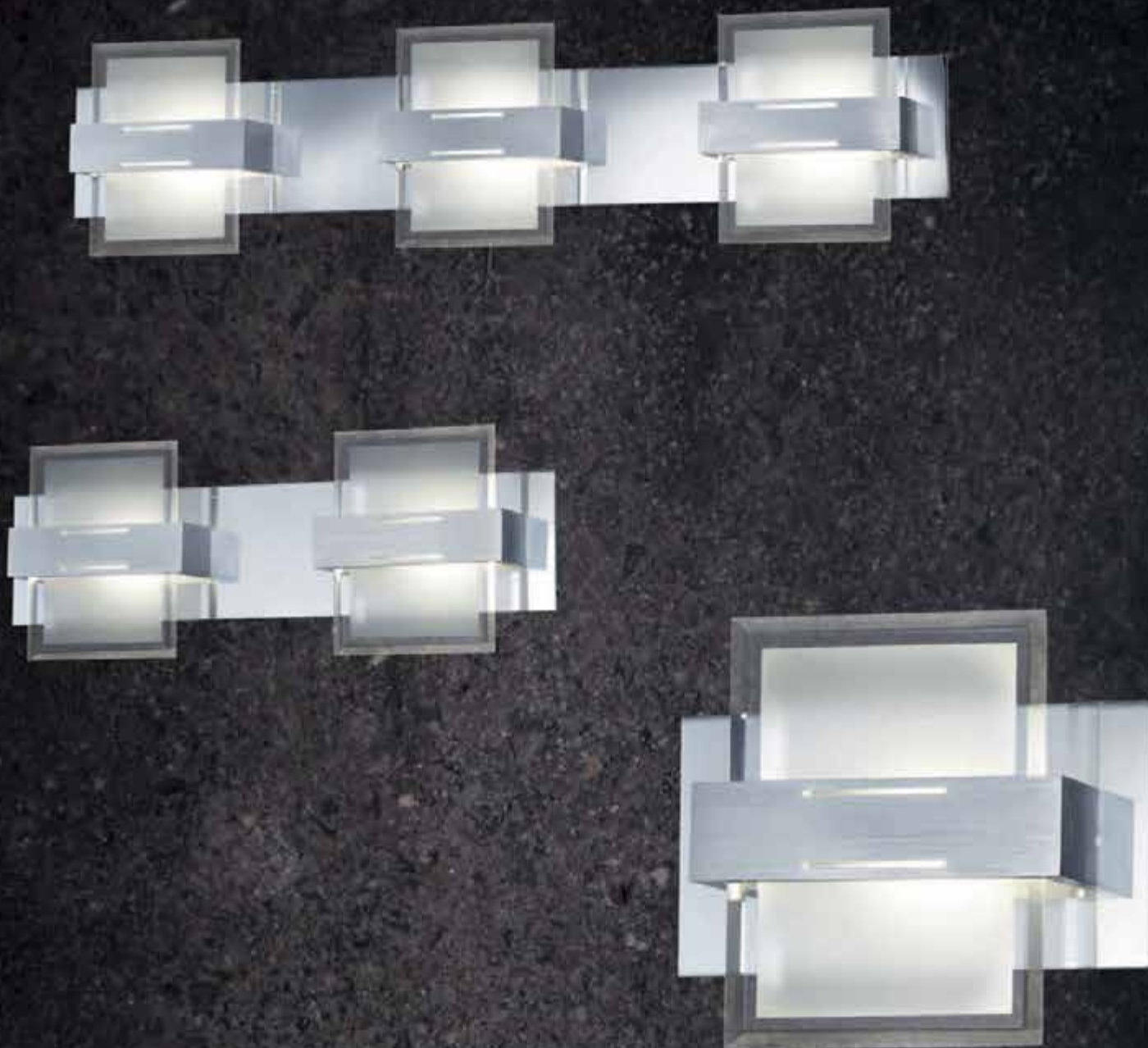

## Juan

chrom, Aluminium gebürstet, Glas satiniert • chrome, brushed aluminium, satinated glass •  
 chrome, aluminium balayé, verre satiné • chrom, geborsteld aluminium, gesatineerd glas •  
 cromo, aluminio pulido, vidrio satinado • cromo, alluminio spazzolato, vetro satinato •  
 crom, aluminiu lucios, sticla satinata • kromi, harjattu alumiini, satinoitu lasi •  
 chrom, aluminium szczotkowane, szkło satynowe • krom, alüminyum, satin cam



↔ 15 x 13 cm, ∅ 7,5 cm  
 incl. 1 x SMD, 4,5 W  
 400 lm, 3.000 K



224670106



↔ 35 x 13 cm, ∅ 7,5 cm  
 incl. 2 x SMD, 4,5 W  
 2 x 400 lm, 3.000 K



224610206



↔ 55 x 13 cm, ∅ 7,5 cm  
 incl. 3 x SMD, 4,5 W  
 3 x 400 lm, 3.000 K



224610306

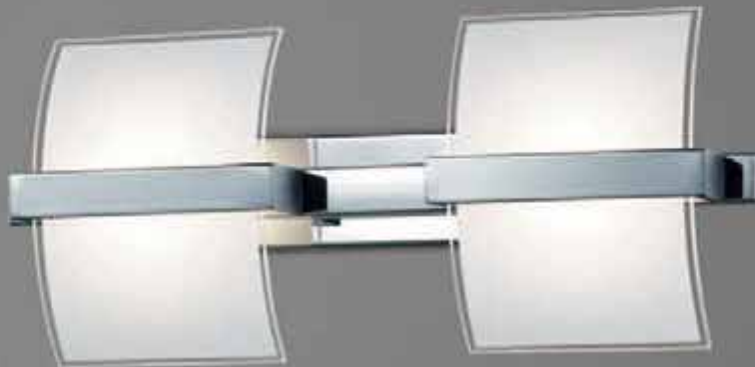
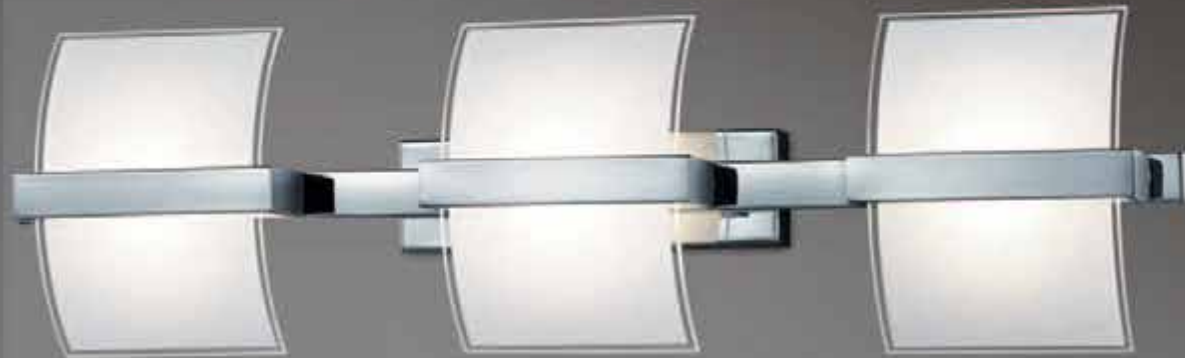

## Colino

chrom, Glas opal • chrome, opal glass • chrome, verre opale •  
 chroom, opaal glas • cromo, vidrio opal • cromo, vetro opale •  
 crom, sticla opala • kromi, opaalilasi • chrom, szkło opal •  
 krom, opal cam



↔ 16 x 18 cm, ∠ 9 cm  
 incl. 1 x SMD, 4,5 W  
 430 lm, 3.000 K

A+

227410106



↔ 42 x 18 cm, ∠ 10 cm  
 incl. 2 x SMD, 4,5 W  
 2 x 430 lm, 3.000 K

A+

227410206



↔ 65 x 18 cm, ∠ 10 cm  
 incl. 3 x COB, 5 W  
 3 x 400 lm, 3.000 K

A+

227410306





## Lentin II

chrom, Glas matt • chrome, mat glass • chrome, verre mat •  
chrom, mat glas • cromo, vidrio mate • cromo, vetro sabbato •  
crom, sticla mata • kromi, mattalasi • chrom, szkło matowane •  
krom, mat cam



Ø 50 cm, 18 cm  
incl. 5 x SMD, 4,5 W  
5 x 400 lm, 3.000 K

A+

628010506



## Pyramid

chrom, Glas satiniert • chrome, satinated glass •  
chrome, verre satiné • chroom, gesatineerd glas • cromo, vidrio satinado • cromo, vetro satinato •  
crom, sticla satinata • kromi, satinoitu lasi • chrom, szkło satynowe • krom, satin cam



334



↔ 38 x 38 cm, ↓ 8 cm  
incl. 1 x SMD, 18 W  
1.400 lm, 3.000 K



628611806



↔ 29 x 29 cm, ↓ 8 cm  
incl. 1 x SMD, 12 W  
960 lm, 3.000 K



628611206



↔ 20 x 20 cm, ↗ 6 cm  
incl. 1 x COB, 5 W  
400 lm, 3.000 K



228610506





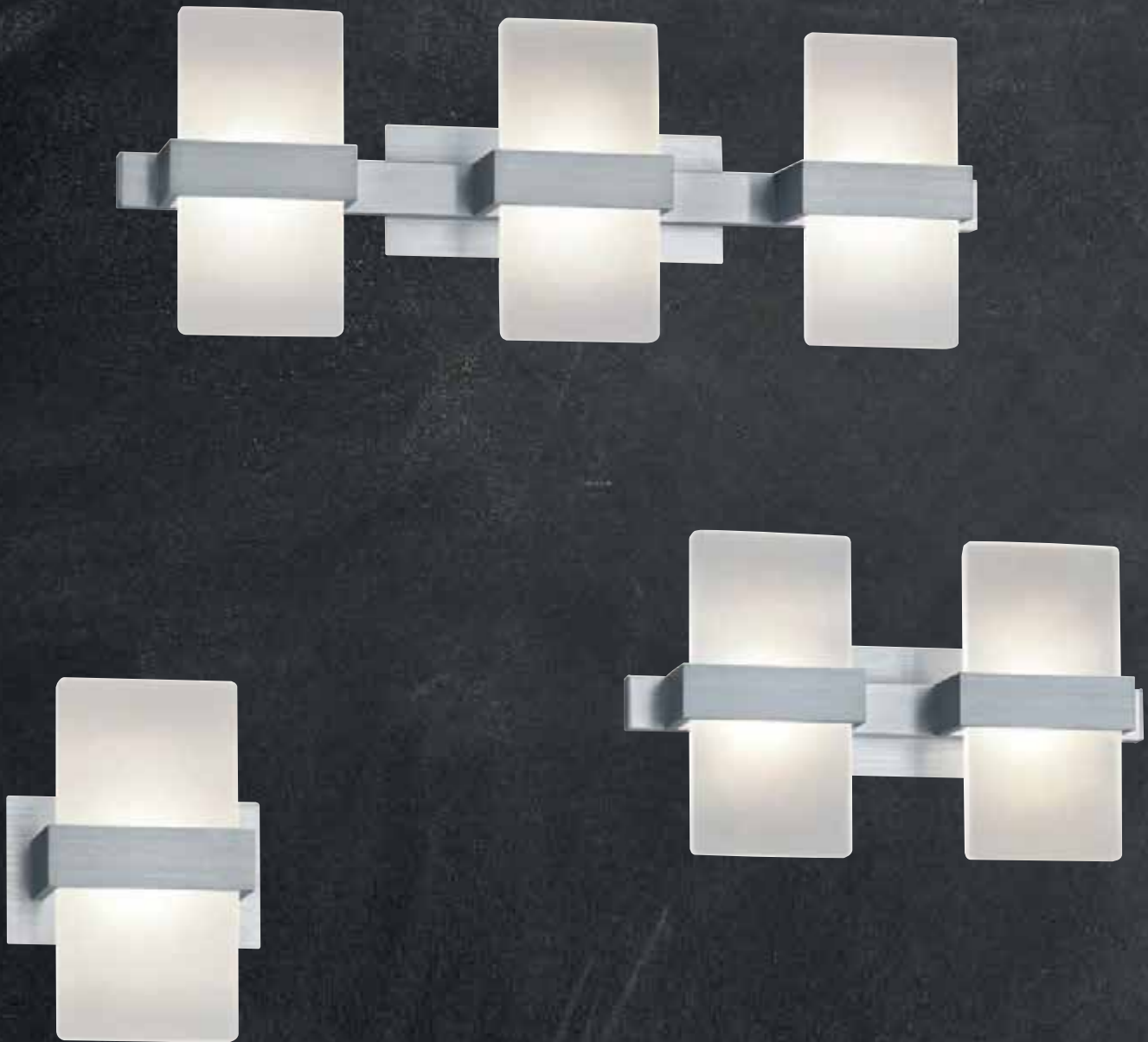

## Platon

Aluminium gebürstet, Acryl • brushed aluminium, acryl •  
 aluminium balayé, acryl • geborsteld aluminium, acryl •  
 aluminio pulido, acrílico • alluminio spazzolato, acrilico •  
 aluminiu lucios, acrilic • harjattu alumiini, akryyli •  
 aluminium szczotkowane, akryl • alüminyum, akrilik



↔ 13 x 18 cm, ∅ 9 cm  
 incl. 1 x SMD, 4,5 W  
 430 lm, 3.000 K



274670105



↔ 30 x 18 cm, ∅ 11 cm  
 incl. 2 x SMD, 4,5 W  
 2 x 430 lm, 3.000 K

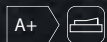

274670205



↔ 45 x 18 cm, ∅ 11 cm  
 incl. 3 x SMD, 4,5 W  
 3 x 430 lm, 3.000 K

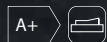

274670305





## Canturo

Nickel matt, Acryl • nickel mat, acryl •  
 nickel mat, acryl • nikkell mat, acryl • níquel mate, acrílico •  
 nichel opaco, acrílico • nichel mat, acrílico harjattu teräs, akryyli •  
 nikiel mat, akryl • mat nikel, akrilik



337



↔ 13 x 13 cm, ∅ 5,5 cm  
 incl. 1 x SMD, 4,5 W  
 340 lm, 3.000 K



275770107



↔ 25,5 x 13 cm, ∅ 5,5 cm  
 incl. 2 x SMD, 4,5 W  
 2 x 340 lm, 3.000 K

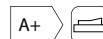

275770207



↔ 38 x 13 cm, ∅ 5,5 cm  
 incl. 3 x SMD, 4,5 W  
 3 x 340 lm, 3.000 K

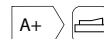

275770307



↔ 35 x 35 cm, ∅ 5,5 cm  
 incl. 5 x SMD, 4,5 W  
 5 x 340 lm, 3.000 K



675710507

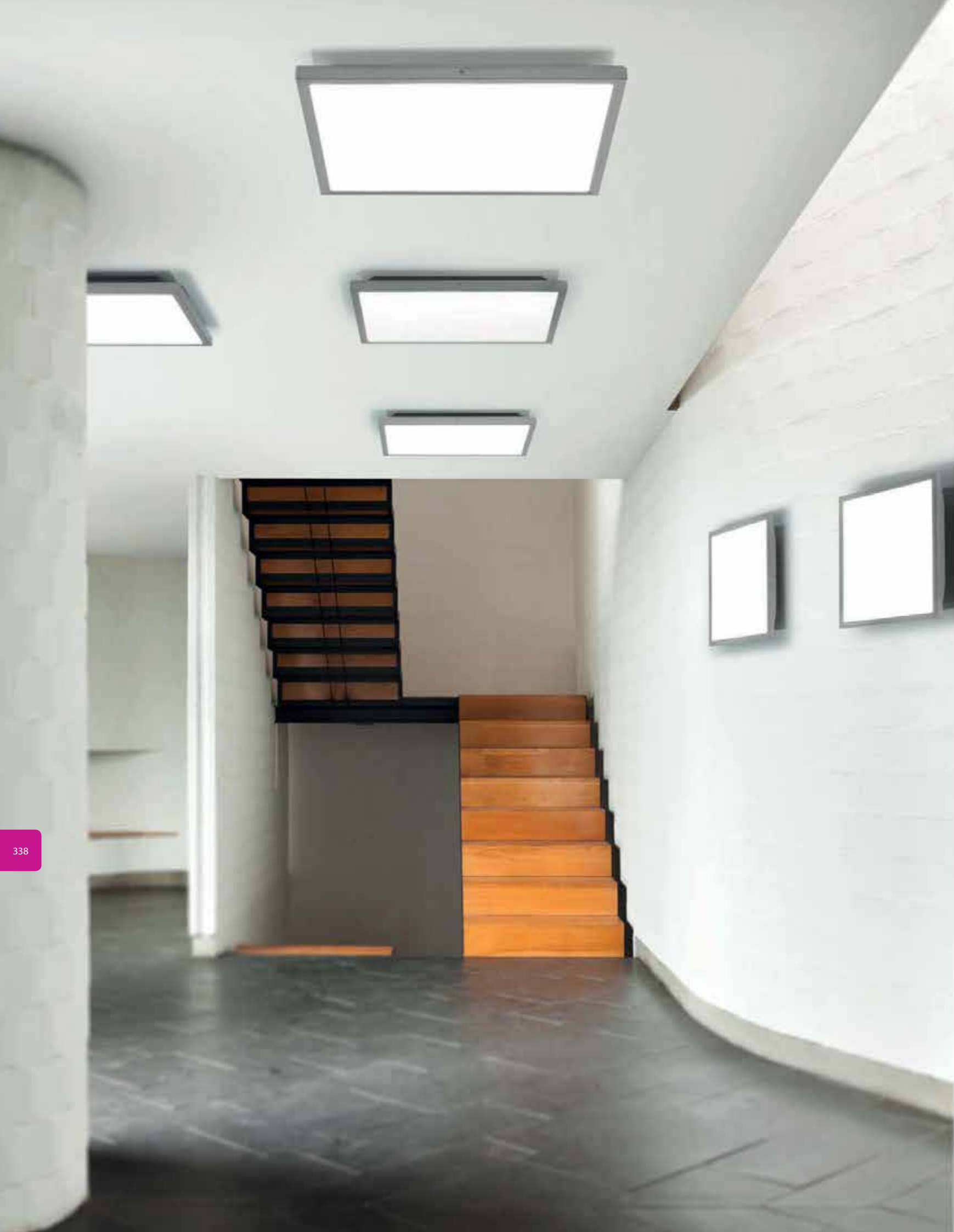



## Future

Edelstahl, Acryl • steel, acryl •  
 acier, acryl • staal, acryl • acero, acrílico • acciaio, acrilico •  
 inox, acrylic • teräs, akryyli • stal, akryl • çelik, akrilik



↔ 60 x 60 cm, ↑ 5,5 cm  
 incl. SMD, 40 W  
 3.000 lm, 3.500 K



622716007  
 C 622716007 Smart control



↔ 40 x 40 cm, ↑ 4,5 cm  
 incl. SMD, 18 W  
 1.600 lm, 3.500 K



622714007



↔ 30 x 30 cm, ↑ 4,5 cm  
 incl. SMD, 12 W  
 1.100 lm, 3.500 K



622713007



# Denver

Metall, Acryl • metal, acryl •  
metale, acryl • metaal, acryl • metal, acrílico • metallo, acrilico •  
metal, acrylic • metalli, akryyli • metal, akryl • metal, akrilik



↔ 30 x 30 cm, ↓ 6 cm  
incl. SMD, 20 W  
1.900 lm, 3.000 K



- 679612006
- 679612007
- 679612008
- 679612028

- C 679612006
- C 679612007
- C 679612008
- C 679612028

- 06** chrom • chrome
- 07** Nickel matt • nickel mat
- 08** Messing matt • brass mat
- 28** rostfarbig antik • antique rust



08



07



28



06





342

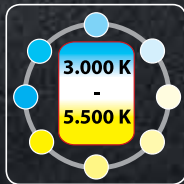

Ø 75 cm, ↑ 14 cm  
incl. SMD, 58 W  
4.800 lm, 3.000-5.500 lm



658715801

Ø 48 cm, ↑ 10 cm,  
incl. SMD, 40 W  
3.600 lm, 3.000-5.500 lm



658714001

# Yokohama

Acryl, Fernbedienung • acryl, remote control •  
acryl, commande à distance • acryl, afstandsbediening • acrílico, mando a distancia •  
acrilico, comando a distanza • acrilic, telecomanda • akryyli, kauko-ohjain •  
akryl, pilot • akrilik, uzaktan kumanda



343



3.000 K



8.500 K







## Kyoto

Acryl, Fernbedienung • acryl, remote control •  
acryl, commande à distance • acryl, afstandsbediening • acrílico, mando a distancia •  
acrílico, comando a distanza • acrilic, telecomanda • akryyli, kauko-ohjain •  
akryl, pilot • akrilik, uzaktan kumanda

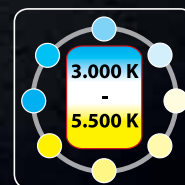

344

↔ 52,5 x 52,5 cm, ↑ 6,5 cm  
incl. SMD, 50 W  
4.000 lm, 3.000-5.500 lm



628815001





## Tokyo

Acryl, Fernbedienung • acryl, remote control •  
acryl, commande à distance • acryl, afstandsbediening • acrílico, mando a distancia •  
acrilico, comando a distanza • acrilic, telecomanda • akryyli, kauko-ohjain •  
akryl, pilot • akrilik, uzaktan kumanda

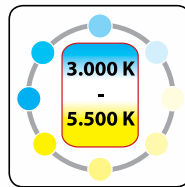

Ø 60 cm, ↓ 6,5 cm  
incl. SMD, 50 W  
4.000 lm, 3.000-5.500 lm



628915001



## Esprit

Aluminium gebürstet, Acryl • brushed aluminium, acryl • aluminium balayé, acryl • geborsteld aluminium, acryl • aluminio pulido, acrílico • alluminio spazzolato, acrilico • aluminiu lucios, acrilic • harjattu alumiini, akryyli • aluminium szczotkowane, akryl • alüminyum, akrilik



## Lordanos

Aluminium gebürstet, Acryl • brushed aluminium, acryl • aluminium balayé, acryl • geborsteld aluminium, acryl • aluminio pulido, acrílico • alluminio spazzolato, acrilico • aluminiu lucios, acrilic • harjattu alumiini, akryyli • aluminium szczotkowane, akryl • alüminyum, akrilik

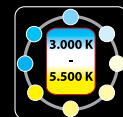

Ø 41 cm, ↓ 11 cm  
incl. SMD, 11 W  
1.100 lm, 3.000 K  
incl. RGB, 4 W  
100 lm, 3.000 K



658811505

Ø 51 cm, ↓ 11,5 cm  
incl. SMD, 23 W  
2.300 lm, 3.000 K  
incl. RGB, 7 W  
200 lm, 3.000 K



658813005

Ø 39,5 cm, ↓ 11 cm  
incl. 1 x SMD, 25 W  
2.100 lm, 3.000 - 5.500 K



620912505



## Nagoya

Acryl • acryl •  
acryl • acryl • acrílico • acrílico • acrilic • akryyli • akryl • akrilik

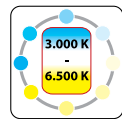

↔ 52 x 52 cm, ↓ 00 cm  
incl. SMD, max. 50 W  
max. 4.800 lm, 3.000 - 6.500 K



628715001





## Shogun

Acryl, Starlight-Effekt, Fernbedienung • acryl, starlight effect, remote control • acryl, effet étoile, commande à distance • acryl, sterlicht effect, afstandsbediening • acrilico, efecto de la luz, mando a distancia • acrilico, effetto di stelle, comando a distanza • acrilic, efect lumina stelelor, telecomanda • akryyli, starlight vaikutus, kauko-ohjain • akryl, efekt starlight, pilot • akrilik, starlight etkisi, uzaktan kumanda

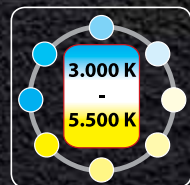

Ø 42,5 cm, ↑ 6 cm  
incl. SMD, 30 W  
2.400 lm, 3.000-5.500 K



628513001





## Samurai

Acryl, Starlight-Effekt, Fernbedienung • acryl, starlight effect, remote control •  
acryl, effet étoile, commande à distance • acryl, sterlicht effect, afstandsbediening •  
acrilico, efecto de la luz, mando a distancia • acrilico, effetto di stelle, comando a distanza •  
acrilic, efect lumina stelelor, telecomanda • akryyli, starlight vaikutus, kauko-ohjain •  
akryl, efekt starlight, pilot • akrilik, starlight etkisi, uzaktan kumanda

 LED

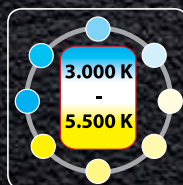

↔ 42,5 x 42,5 cm, ↑ 6 cm  
incl. SMD, 30 W  
2.400 lm, 3.000-5.500 K



628613001



## Marcos

Aluminium gebürstet, Acryl • brushed aluminium, acryl •  
aluminium balayé, acryl • geborsteld aluminium, acryl •  
aluminio pulido, acrílico • alluminio spazzolato, acrilico •  
aluminiiu lucios, acrilic • harjattu alumiini, akryyli •  
aluminium szczotkowane, akryl • alüminyum, akrilik



↔ 28 x 28 cm, ↑ 9 cm  
incl. SMD, 12 W  
1.050 lm, 3.000 K



625911205



↔ 43 x 43 cm, ↑ 10 cm  
incl. SMD, 23 W  
2.000 lm, 3.000 K



625912305





## Lucas

Aluminium gebürstet, Acryl • brushed aluminium, acryl •  
 aluminium balayé, acryl • geborsteld aluminium, acryl •  
 aluminio pulido, acrílico • alluminio spazzolato, acrilico •  
 aluminium lucios, acrilic • harjattu alumiini, akryyli •  
 aluminium szczotkowane, akryl • alüminyum, akrilik



↔ 31,5 x 31,5 cm, ↑ 4,5 cm  
 incl. SMD, 16 W  
 1.450 lm, 3.000 K



659511605



↔ 41,5 x 41,5 cm, ↑ 4,5 cm  
 incl. SMD, 24 W  
 2.000 lm, 3.000 K

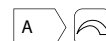

659512405



↔ 81,5 x 31,5 cm, ↑ 5 cm  
 incl. SMD, 30 W  
 3.000 lm, 3.000 K

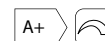

659513605



28



07

## Casillas

Nickel matt oder rostfarbig antik, Glas satiniert • nickel mat or antique rust, satinated glass •  
 nickel mat ou rouille antique, verre satiné • nikkel mat ofroestkleur antiek, gesatineerd glas •  
 níquel mate o oxido, vidrio satinado • nichel opaco o ruggine anticato, vetro satinato • nichel mat sau  
 ruginiu antic, sticla satinata • harjattu teräs tai rustiikki, satinoitu lasi • nikiel mat lub antyczny rdzawy,  
 szkło satynowe • mat nikel veyá antik pas rengi, satin cam



↔ 42 x 19 cm, ↓ 8 cm  
 incl. 2 x SMD, 4,5 W  
 2 x 400 lm, 3.000 K



223570207  
 223570228



↔ 42,5 x 42,5 cm, ↓ 8 cm  
 incl. 4 x SMD, 4,5 W  
 4 x 400 lm, 3.000 K

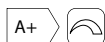

623510407  
 623510428



**07** Nickel matt • matt nickel  
**28** rostfarbig antik • antique rusty





## Iker

chrom, Glas opal • chrome, opal glass •  
chrome, verre opale • chroom, opaal glas • cromo, vidrio opal •  
cromo, vetro opale • crom, sticla opala • kromi, opaalilasi •  
chrom, szkło opal • krom, opal cam



↔ 29,5 x 29,5 cm, ↑ 6,5 cm  
incl. 1 x SMD, 10 W  
980 lm, 3.000 K



625511006



↔ 38 x 38 cm, ↑ 7 cm  
incl. 1 x SMD, 18 W  
1.750 lm, 3.000 K



625511806



## Concorde

Acryl • acryl •  
acryl • acryl • acrílico • acrílico • acrilic • akryyli • akryl • akrilik

### LED autoDimmer

Stufenlos dimmbar mit herkömmlichem Lichtschalter · infinitely dimmable with conventional lightswitch · infiniment dimmable avec interrupteur conventionnel · traploos dimbaar met conventionele lichtschakelaar · infinitamente dimmable con interruptor convencional · infinitamente dimmerabile con interruttore convenzionale · infinit estompat cu comutator de convenționale · äärettömän himmennettävä tavanomaisen kytkin · nieskończenie ściemniania z zwykły przełącznik · geleneksel anahtarı ile sonsuz kısılabilir

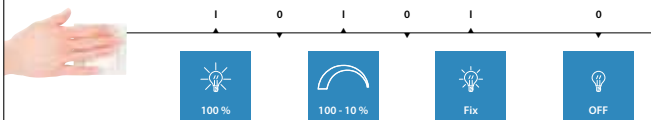

↔ 43 x 43 cm, ↑ 9 cm  
incl. SMD, 21 W  
max. 2.000 lm, 3.000 K

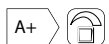

658512601



Ø 41 cm, ↑ 9 cm  
incl. SMD, 21 W  
max. 2.000 lm, 3.000 K

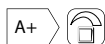

658412601

# Congress

Acryl • acryl •  
acryl • acryl • acrílico • acrílico • acrilic • akryyli • akryl • akrilik

LED autoDimmer





## Converter

Acryl • acryl •  
acryl • acryl • acrílico • acrílico •  
acrílico • akryyli • akryl • akrilik

## LED autoDimmer



Ø 30 cm, ↑ 9,5 cm  
incl. SMD, 11 W  
max. 1.000 lm, 3.000 K



658311401



Ø 40 cm, ↑ 10 cm  
incl. SMD, 21 W  
max. 2.000 lm, 3.000 K



658312601





## Contender

Nickel matt, Acryl · nickel mat, acryl ·  
 nickel mat, acryl · nikkell mat, acryl · níquel mate, acrílico ·  
 nichel opaco, acrílico · nichel mat, acrílico · harjattu teräs, akryyli ·  
 nikiel mat, akryl · mat nikel, akrilik

### LED autoDimmer

Stufenlos dimmbar mit herkömmlichem Lichtschalter · infinitely dimmable with conventional lightswitch · infiniment dimmable avec interrupteur conventionnel · traploos dimbaar met conventionele lichtschakelaar · infinitamente dimmable con interruptor convencional · infinitamente dimmerabile con interruttore convenzionale · infinit estompat cu comutator de convenționale · äärettömän himmennettävä tavanomaisen kytkin · nieskończenie ściemniania z zwykły przełącznik · geleneksel anahtarı ile sonsuz kısılabilir

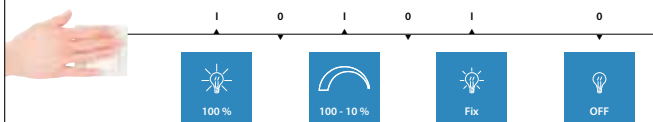

Ø 31 cm, ↓ 9 cm  
 incl. SMD, 11 W  
 max. 1.050 lm, 3.000 K

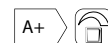

658611407



Ø 42 cm, ↓ 10 cm  
 incl. SMD, 21 W  
 max. 2.000 lm, 3.000 K

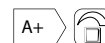

658612607



87



01

42

15

358

# Cornet

Acryl • acryl •  
acryl • acryl • acrílico • acrílico • acrilic • akryyli • akryl • akrilik



↔ 40,5 x 40,5 cm, ↑ 9,5 cm  
incl. 4 x SMD, 4,5 W  
4 x 400 lm, 3.000 K

A+



678811801  
678811815  
678811842  
678811887

01 weiß • white  
15 grün • green  
42 anthrazit • anthracite  
87 titanfarbig • titanium-coloured



## Linaro

chrom, Acryl • chrome, acryl •  
chrome, acryl • chroom, acryl • cromo, acrílico • cromo, acrílico •  
chrom, acrilic • kromi, akryyli • chrom, akryl • krom, akrilik



Ø 45 cm, ↓ 11 cm  
incl. SMD, 24 W  
2.100 lm, 3.000 K



659112406



07



08

## Alvaro

Nickel matt oder Messing matt, Glas matt • nickel mat or brass mat, mat glass • nickel mat ou laiton mat, verre mat • nikkell mat of messing mat, mat glas • niquel mate o bronze mate, vidrio mate • nichel opaco o ottone satinato, vetro sabbiato • nichel mat sau bronz mat, sticla mata • harjattu teräs tai mattamessinki, mattalasi • nikiel mat lub mosiądz mat, szkło matowane • mat nikel veya mat pirinç, mat cam



360



Ø 30 cm, ↓ 9,5 cm  
incl. SMD, 13 W  
1.200 lm, 3.000 K



625211007  
625211008



Ø 41 cm, ↓ 11 cm  
incl. SMD, 22,5 W  
2.000 lm, 3.000 K



625211807  
625211808



**07** Nickel matt • matt nickel  
**08** Messing matt • matt brass





## Nicolas

chrom, Acryl • chrome, acryl •  
chrome, acryl • chroom, acryl • cromo, acrílico •  
cromo, acrilico • crom, acrilic • kromi, akryyli •  
chrom, akryl • krom, akrilik



Ø 31 cm, ↑ 9 cm  
incl. SMD, 12 W  
1.050 lm, 3.000 K

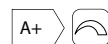

624011206



Ø 42 cm, ↑ 10 cm  
incl. SMD, 25 W  
2.000 lm, 3.000 K



624012306



## Manuel

Acryl • acryl •  
acryl • acryl • acrílico • acrilico •  
acrilic • akryyli • akryl • akrilik



01



87

## Joel

Acryl • acryl •  
acryl • acryl • acrílico • acrilico •  
acrilic • akryyli • akryl • akrilik



362



Ø 29 cm, ↓ 5,4 cm  
incl. SMD, 10 W  
730 lm, 3.000 K



627111001  
627111087



Ø 33 cm, ↓ 5,4 cm  
incl. SMD, 15 W  
1.100 lm, 3.000 K



627111501  
627111587



↔ 27 x 27 cm, ↓ 4,5 cm  
incl. SMD, 10 W  
730 lm, 3.000 K



627211001  
627211087



↔ 31 x 31 cm, ↓ 4,5 cm  
incl. SMD, 15 W  
1.100 lm, 3.000 K



627211501  
627211587



**01** weiß • white  
**87** titanfarbig • titanium-coloured



87



01

# Gonzalo

Acryl • acryl •  
acryl • acryl • acrílico • acrílico • acrilic • akryyli • akryl • akrilik



Ø 30 cm, 1 8 cm  
incl. SMD, 9 W  
750 lm, 3.000 K

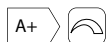

626510901  
626510987



Ø 34 cm, 1 9 cm  
incl. SMD, 12 W  
1.050 lm, 3.000 K

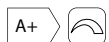

626511201  
626511287



Ø 42 cm, 1 9 cm  
incl. SMD, 25 W  
2.000 lm, 3.000 K



626512501  
626512587



01 weiß • white  
87 titanfarbig • titanium-coloured



## Zeus

Metall, Acryl • metal, acryl •  
metale, acryl • metaal, acryl • metal, acrílico • metallo, acrilico •  
metal, acrilic • metalli, akryyli • metal, akryl • metal, akrilik



↔ 12 x 12 cm, ↓ 3,5 cm  
incl. 1 x SMD, 5 W  
700 lm, 3.000 K

A++

657110601  
657110607



↔ 17 x 17 cm, ↓ 3,5 cm  
incl. 1 x SMD, 11 W  
1.300 lm, 3.000 K

A+

657111201  
657111207



↔ 22,5 x 22,5 cm, ↓ 3,5 cm  
incl. 1 x SMD, 16,5 W  
2.000 lm, 3.000 K

A+

657111801  
657111807



**01** weiß • white  
**07** Nickel matt • matt nickel





07

01

## Cento

Metall, Acryl • metal, acryl •  
 metale, acryl • metaal, acryl • metal, acrílico • metallo, acrilico •  
 metal, acrylic • metalli, akryyli • metal, akryl • metal, akrilik



Ø 12 cm, ↑ 3,5 cm  
 incl. 1 x SMD, 5 W  
 700 lm, 3.000 K



657010601  
 657010607



Ø 17 cm, ↑ 3,5 cm  
 incl. 1 x SMD, 11 W  
 1.300 lm, 3.000 K



657011201  
 657011207



Ø 23 cm, ↑ 3,5 cm  
 incl. 1 x SMD, 16,5 W  
 2.000 lm, 3.000 K



657011801  
 657011807



**01** weiß • white  
**07** Nickel matt • matt nickel



06



01

## Pageno

Metall, Glas satiniert • metal, satinated glass •  
metale, verre satiné • metaal, gesatineerd glas • metal, vidrio satinado •  
metallo, vetro satinato • metal, sticla satinata • metalli, satinoitu lasi •  
metal, szkło satynowe • metal, satin cam



87



01

## Pacco

Metall, Dekorglas • metal, glas decorated •  
metale, verre décoré • metaal, decoratief glas • metal, vidrio decorado •  
metallo, vetro decorato • metal, sticla decorativa • metalli, ornamenttilasi •  
metal, szkło dekoracyjne • metal, dekoratif cam



Ø 30 cm, ↑ 8 cm  
incl. 1 x SMD, 10 W  
800 lm, 3.000 K

A+

677211001  
677211006  
677211087



Ø 30 cm, ↑ 8 cm  
incl. 1 x SMD, 10 W  
800 lm, 3.000 K

A+

677111001  
677111087



01 weiß • white  
06 chrom • chrome  
87 titanfarbig • titanium-coloured

## Facette

chrom, Facettenglas • chrome, faceted glass •  
chrome, verre à facettes • chrom, facet glas • cromo, cristal facetado •  
cromo, vetro sfaccettato • crom, sticlă fațetată • kromi, fasettihiottuja •  
chrom, szkło szlifowane • krom, yönlü cam



## Cristalina

Dekorglas • glas decorated •  
verre décoré • decoratief glas • vidrio decorado •  
vetro decorato • sticla decorativa • ornamenttilasi •  
szkło dekoracyjne • dekoratif cam



Ø 30 cm, 1 8 cm  
incl. 1 x SMD, 10 W  
800 lm, 3.000 K



629110106



Ø 25 cm, 1 9,5 cm  
incl. 1 x SMD, 10 W  
850 lm, 3.000 K



659611006



Ø 33 cm, 1 10,5 cm  
incl. 1 x SMD, 15 W  
1.200 lm, 3.000 K



659611506



Ø 40 cm, 1 12 cm  
incl. 1 x SMD, 18 W  
1.600 lm, 3.000 K

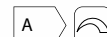

659612006



24



08



07



Ø 50 cm, ↓ 16 cm  
incl. 3 x G9, 28 W  
3 x 370 lm, 2.800 K



6380031-07  
6380031-08  
6380031-24

Ø 50 cm, ↓ 16 cm  
incl. 5 x G9, 28 W  
5 x 370 lm, 2.800 K



6380051-07  
6380051-08  
6380051-24



**07** Nickel matt • matt nickel  
**08** Messing matt • matt brass  
**24** rostfarbig • rusty





## Lentin

Nickel matt, Messing matt oder rostfarbig, Glas • nickel mat, brass mat or rusty, glass •  
nickel mat, laiton mat ou rouille, verre • nikkel mat, messing mat of roestkleur, glas •  
níquel mate, bronze mate o óxido, vidrio • nichel opaco, ottone satinato o ruggine, vetro •  
nichel mat, bronz mat sau ruginiu, sticla • harjattu teräs, mattamessinki tai rustiikki, lasi •  
nikiel mat, mosiądz mat lub miedź, szkło • mat nikel, mat pirinç veya pas, cam

369



↔ 110 x 46 cm, ↓ 13 cm  
incl. 6 x G9, 28 W  
6 x 370 lm, 2.800 K



638090607  
638090624



**07** Nickel matt • matt nickel  
**24** rostfarbig • rusty



## Curva

Nickel matt, Glas matt • nickel mat, mat glass •  
 nickel mat, verre mat • nikkel mat, mat glas • níquel mate, vidrio mate •  
 nichel opaco, vetro sabbiato • nichel mat, sticla mata • harjattu teräs,  
 mattalasi • nikiel mat, szkło matowane • mat nikel, mat cam



↔ 50 x 20 cm, ↓ 27 cm  
 excl. 3 x E14, max. 40 W

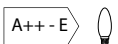

605600307



↔ 72 x 28 cm, ↓ 27 cm  
 excl. 5 x E14, max. 40 W

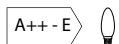

605600507



## Disc

chrom, Acryl • chrome, acryl •  
chrome, acryl • chroom, acryl • cromo, acrílico • cromo, acrilico •  
crom, acrilic • kromi, akryyli • chrom, akryl • krom, akrilik

371



Ø 45 cm, ↑ 25 cm  
excl. 3 x E14, max. 40 W

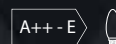

609000306



87



14



01

# Embassy

Stoff • fabric •  
tissu • textiel • tela • tessuto • textil •  
tekstiili • tkanina • kumaş

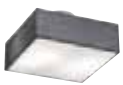

↔ 30 x 30 cm, ↓ 16 cm  
excl. 2 x E14, max. 40 W

↔ 50 x 50 cm, ↓ 17 cm  
excl. 4 x E27, max. 60 W

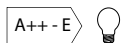
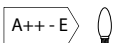

603800201  
603800214  
603800287

603800401  
603800414  
603800487

01 weiß • white  
14 braun • brown  
87 titanfarbig • titanium-coloured







## Campo

rostfarbig, Scavo glas • rusty, scavo glass •  
rouille, verre scavo • roestkleur, scavo glas • óxido, vidrio scavo •  
ruggine, vetro scavo • ruginiu, sticla scavo • rustiikki, scavo-lasi •  
miedź, szkło scavo • pas, scavo cam

374



↑ 44 cm, ↔ 12 cm, ↗ 16 cm  
excl. 1 x E14, max. 40 W

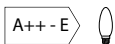

200970124



Ø 40 cm, ↓ 10,5 cm  
excl. 2 x E27, max. 40 W

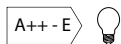

600900224



## Quinta

rostfarbig, Glas alabasterfarbig • rusty, alabaster-coloured glass • rouille, verre couleur albâtre • roestkleur, albastkleurig glas • óxido, vidrio de color alabastro • ruggine, vetro colore alabastro • ruginiu, sticla culoare alabastru • rustiikki, lasi alabasteri väri • miedz, szkło alabaster kolor • pas, cam kaymaktaşi rengi



Ø 33 cm, 1 20 cm  
excl. 2 x E27, max. 40 W

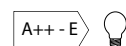

608100224



Ø 42 cm, 1 32 cm  
excl. 3 x E27, max. 60 W

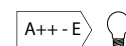

608100324



## Bianca

Dekorglas • glas decorated •  
verre décoré • decoratief glas • vidrio decorado •  
vetro decorato • sticla decorativa • ornamenttilasi •  
szkło dekoracyjne • dekoratif cam



↔ 23 x 29 cm, ↗ 8 cm  
excl. 1 x E27, max. 40 W

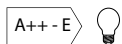

203100100



Ø 30 cm, ↑ 8 cm  
excl. 1 x E27, max. 40 W

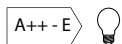

603100100



Ø 40 cm, ↑ 9,5 cm  
excl. 2 x E27, max. 40 W

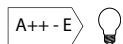

603100200





## Alba

Dekorglas • glas decorated •  
verre décoré • decoratief glas • vidrio decorado •  
vetro decorato • sticla decorativa • ornamentilasi •  
szkło dekoracyjne • dekoratif cam



## Lucia

Dekorglas • glas decorated •  
verre décoré • decoratief glas • vidrio decorado •  
vetro decorato • sticla decorativa • ornamentilasi •  
szkło dekoracyjne • dekoratif cam

377



Ø 25 cm, 1 8 cm  
excl. 1 x E27, max. 40 W

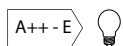

601900100



Ø 30 cm, 1 8,5 cm  
excl. 2 x E27, max. 40 W

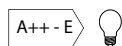

601900200



Ø 30 cm, 1 8 cm  
excl. 2 x E14, max. 40 W

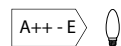

602600200



Ø 40 cm, 1 9 cm  
excl. 2 x E27, max. 40 W

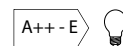

602700200



01



24

## Adrian

Glas alabasterfarbig oder Glas amber • alabaster-coloured glass or glass amber • verre couleur albâtre ou verre ambre • albastkleurig glas of glas amber • vidrio de color alabastro o vidrio ámbar • vetro colore alabastro o vetro ambra • sticla culoare alabastru sau sticla amber • lasi alabasteri väri tai lasi meripihka • szkło alabaster kolor lub szkło bursztynowy • cam kaymaktaşı rengi veya cam amber



Ø 30 cm, ↑ 9 cm  
excl. 1 x E27, max. 40 W

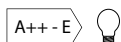

6105011-01  
6105011-24



Ø 40 cm, ↑ 10 cm  
excl. 2 x E27, max. 40 W

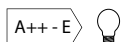

6105021-01  
6105021-24



01 weiß • white  
24 amber • amber



## Carlos

Nickel matt, Glas alabasterfarbig • nickel mat, alabaster-coloured glass • nickel mat, verre couleur albâtre • nikkell mat, albastkleurig glas • níquel mate, vidrio de color alabastro • nichel opaco, vetro colore alabastro • nichel mat, sticla culoare alabastru • harjattu teräs, lasi alabasteri väri • nikiel mat, szkło alabaster kolor • mat nikel, cam kaymaktaşı rengi



## Bulto

Nickel matt, Glas matt • nickel mat, mat glass • nickel mat, verre mat • nikkell mat, mat glas • níquel mate, vidrio mate • nichel opaco, vetro sabbiato • nichel mat, sticla mata • harjattu teräs, mattalasi • nikiel mat, szkło matowane • mat nikel, mat cam



Ø 30 cm, ↑ 10 cm  
excl. 1 x E27, max. 60 W

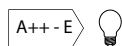

6151011-01



Ø 40 cm, ↑ 10 cm  
excl. 2 x E27, max. 60 W

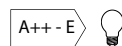

6151021-01



Ø 29 cm, ↑ 11,7 cm  
excl. 1 x E27, max. 60 W

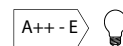

6107011-07



Ø 40 cm, ↑ 14,3 cm  
excl. 2 x E27, max. 60 W

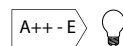

6107021-07



## Carbonada

Dekorglas • glas decorated •  
verre décoré • decoratief glas • vidrio decorado •  
vetro decorato • sticla decorativa • ornamentilasi •  
szkło dekoracyjne • dekoratif cam



↔ 22 x 20 cm, ↗ 10 cm  
excl. 1 x E14, max. 40 W

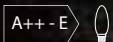

202400106



Ø 25 cm, ↑ 9,5 cm  
excl. 1 x E27, max. 40 W

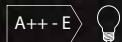

602400106



Ø 30 cm, ↑ 10,5 cm  
excl. 2 x E27, max. 40 W

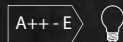

602400206





## Andrea

chrom, Acryl • chrome, acryl •  
 chrome, acryl • chroom, acryl • cromo, acrílico •  
 cromo, acrílico • crom, acrílic • kromi, akryyli •  
 chrom, akryl • krom, akrilik



## Floris

Dekorglas • glas decorated •  
 verre décoré • decoratief glas • vidrio decorado •  
 vetro decorato • sticla decorativa • ornamenttilasi •  
 szkło dekoracyjne • dekoratif cam

381

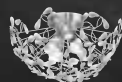

Ø 45 cm, ↑ 27 cm  
 excl. 4 x E14, max. 40 W

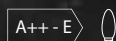

609200406



↔ 28,5 x 28,5 cm, ↑ 8,5 cm  
 excl. 1 x E27, max. 40 W

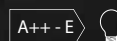

604200106



↔ 32,5 x 32,5 cm, ↑ 9 cm  
 excl. 2 x E27, max. 40 W

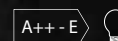

604200206



## Espejo

Spiegelglas, Glas satiniert • mirror glass, satinated glass • verre miroir, verre satiné • spiegelglas, gesatineerd glas • espejo de cristal, vidrio satinado • specchio, vetro satinato • sticlă oglinda, sticla satinata • peililasi, satinoitu lasi • lustro szkło, szkło satynowe • ayna cam, satin cam

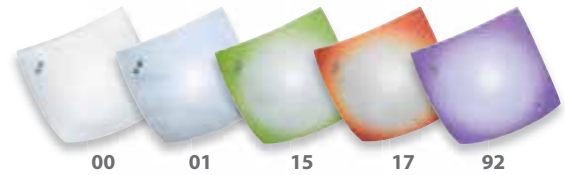

## Busa

Glas • glass • verre • glas • vidrio • vetro • sticla • lasi • szkło • cam



↔ 26 x 26 cm, ↓ 8,2 cm  
excl. 1 x E14, max. 40 W

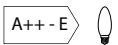

601100100

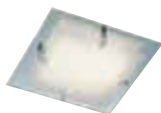

↔ 32 x 32 cm, ↓ 8,2 cm  
excl. 2 x E14, max. 40 W

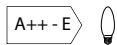

601100200



↔ 23 x 23 cm, ↓ 7,5 cm  
excl. 1 x E27, max. 40 W

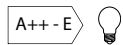

601400100 opal • opal  
601400101 alabasterfarbig • alabaster-coloured  
601400106 weiß satiniert • white satinated  
601400115 grün • green  
601400117 orange • orange  
601400192 purpurrot • purple



## Cormint

Glas • glass •  
verre • glas • vidrio • vetro •  
sticla • lasi • szkło • cam



↔ 20 x 22 cm, ↕ 8 cm  
excl. 1 x E14, max. 40 W

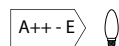

204000106



Ø 25 cm, ↕ 7,5 cm  
excl. 1 x E27, max. 40 W

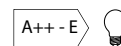

604000106



Ø 30 cm, ↕ 8,5 cm  
excl. 2 x E27, max. 40 W

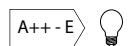

604000206



## Nora

Dekorglas • glas decorated •  
 verre décoré • decoratief glas • vidrio decorado •  
 vetro decorato • sticla decorativa • ornamenttilasi •  
 szkło dekoracyjne • dekoratif cam



07



01

## Lana

Glas • glass •  
 verre • glas • vidrio • vetro • sticla • lasi • szkło • cam



Ø 25 cm, ↑ 8 cm  
 excl. 1 x E27, max. 40 W

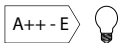

602100100



Ø 30 cm, ↑ 8,5 cm  
 excl. 2 x E27, max. 40 W

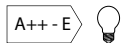

602100200



Ø 25 cm, ↑ 8 cm  
 excl. 1 x E27, max. 40 W

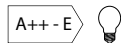

6196011-01 weiß matt • white mat  
 6196011-07 alabasterfarbig • alabaster-coloured



## Chico

Glas • glass •  
verre • glas • vidrio • vetro • sticla • lasi • szkło • cam



07



01



06

## Primo

Metall, Glas • metal, glass •  
metale, verre • metaal, glas • metal, vidrio • metallo, vetro •  
metal, sticla • metalli, lasi • metal, szkło • metal, cam



Ø 30 cm, 1 7,5 cm  
excl. 1 x E27, max. 60 W

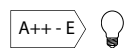

6160011-00



Ø 30 cm, 1 7,5 cm  
excl. 1 x E27, max. 60 W

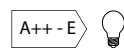

6101011-01  
6101011-06  
6101011-07



01 weiß • white  
06 chrom • chrome  
07 Nickel matt • nickel mat



04



06

## Cuadro

altmessing, chrom oder Nickel matt • old brass, chrome or nickel mat •  
 laiton fumé, chrome ou nickel mat • oud brons, chrom of nikkel mat •  
 bronce viejo, cromo o níquel mate • ottone invecchiato, cromo o nichel opaco •  
 bronz antic, crom sau nichel mat • antiikkimessinki, kromi tai harjattu teräs •  
 patyna, chrom lub nikel mat • antik piring, krom veya mat nikel



↔ 48 x 10,5 cm, ∇ 10 cm  
 incl. 1 x SMD, 8 W  
 600 lm, 3.000 K

A



225210104  
 225210106  
 225210107

04 altmessing • old brass  
 06 chrom • chrome  
 07 Nickel matt • nickel mat

07





04



07



08

## Curtis

altmessing, Nickel matt oder Messing matt • old brass, nickel mat or brass mat •  
 laiton fumé, nickel mat ou laiton mat • oud brons, nikkell mat of messing mat •  
 bronze viejo, níquel mate o bronze mate • ottone invecchiato, nichel opaco o  
 ottone satinato • bronz antic, nichel mat sau bronz mat • antiikkimesinki,  
 harjattu teräs tai mattamessinki • patyna, nikiel mat lubmosiędz mat •  
 antik piriç, mat nikel veya mat piriç



↔ 18,5 cm, ↗ max. 35 cm  
 incl. SMD, 4 W  
 380 lm, 3.000 K



279770104  
 279770107  
 279770108



↑ 35 cm, ↗ max. 18,5  
 incl. SMD, 4 W  
 380 lm, 3.000 K



579790104  
 579790107  
 579790108



04 Altmessing • old brass  
 07 Nickel matt • matt nickel  
 08 Messing matt • matt brass





07



31



## Lacapo

Metall • metal •  
metale • metaal • metallo • metal • metalli • metal • metal



↔ 10,5 cm, ↑ 6 cm, ↗ 15 cm  
incl. SMD, 4,5 W  
430 lm, 3.000 K



223410107  
223410131  
223410132



**07** Nickel matt • nickel mat  
**31** weiß matt • white mat  
**32** schwarz matt • black mat





32



28



06

07

## Bolero

Metall • metal •  
metale • metaal • metal • metallo •  
metal • metalli • metal • metal



↑ 38 x 6 cm, ↗ 8 cm  
incl. 2 x SMD, 3,2 W  
2 x 300 lm, 3.000 K



221570206  
221570207  
221570228



06 chrom • chrome  
07 Nickel matt • matt nickel  
28 rostfarbig antik • antique rusty



# Lips

Metall • metal •  
metale • metaal • metal • metallo •  
metal • metalli • metal • metal



02



01



05



- 01 weiß • white
- 02 schwarz • black
- 05 Aluminium gebürstet • brushed aluminium



↔ 15 x 21 cm, ∅ 10 cm  
incl. 1 x SMD, 4,5 W  
400 lm, 3.000 K

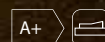

227170101  
227170102  
227170105



## Adriano

Aluminium gebürstet oder weiß • brushed aluminium or white • aluminium balayé ou blanc • geborsteld aluminium of wit • aluminio pulido o blanco • alluminio spazzolato o bianco • aluminiu lucios sau alb • harjattu alumiini tai valkoinen • aluminium szczotkowane lub biały • alüminyum veya beyaz



## Cologne

Aluminium gebürstet • brushed aluminium • aluminium balayé • geborsteld aluminium • aluminio pulido • alluminio spazzolato • aluminiu lucios • harjattu alumiini • aluminium szczotkowane • alüminyum



↔ 30 x 6 cm, ↗ 8 cm  
incl. 2 x SMD, 3,2 W  
2 x 300 lm, 3.000 K

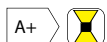

220810201  
220810205



↔ 8 cm, ↑ 8 cm, ↗ 4,5 cm  
incl. 2 x SMD, 2,3 W  
2 x 150 lm, 3.200 K



220110205



01 weiß • white  
05 Aluminium gebürstet • brushed aluminium



## Aberdeen

Nickel matt • nickel mat •  
nickel mat • nikkel mat • níquel mate • nichel opaco •  
nichel mat • harjattu teräs • nikiel mat • mat nikel



↔ 20 cm, ↑ 8 cm, ↙ 7 cm  
incl. 6 x SMD, 1 W  
6 x 100 lm, 3.000 K



225610607



06



07



01

## Rotario

Metall • metal •  
metale • metaal • metal • metallo •  
metal • metalli • metal • metal



↔ 14 x 14 cm, 2 6 cm  
incl. 2 x SMD, 5 W  
2 x 450 lm, 3.000 K



223170201  
223170206  
223170207



01 weiß • white  
06 chrom • chrome  
07 Nickel matt • matt nickel



## Wales

Nickel matt • nickel mat •  
nickel mat • nikkell mat •  
níquel mate • nichel opaco •  
nichel mat • harjattu teräs •  
nikiel mat • mat nikel



397



↔ 9 cm, ↑ 9 cm, ↙ 6 cm  
incl. 2 x SMD, 3,2 W  
2 x 300 lm, 3.000 K

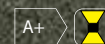

225510207

## Oval

chrom, Acryl • chrome, acryl •  
chrome, acryl • chroom, acryl • cromo, acrílico • cromo, acrílico •  
crom, acrílic • kromi, akryyli • chrom, akryl • krom, akrilik



## Valerio

Nickel matt, Acryl • nickel mat, acryl •  
nickel mat, acryl • nikkell mat, acryl • níquel mate, acrílico •  
nichel opaco, acrílico • nichel mat, acrílic • harjattu teräs, akryyli •  
nikiel mat, akryl • mat nikel, akrilik



## Valeria

Nickel matt, Acryl • nickel mat, acryl •  
nickel mat, acryl • nikkell mat, acryl • níquel mate, acrílico •  
nichel opaco, acrílico • nichel mat, acrílic • harjattu teräs, akryyli •  
nikiel mat, akryl • mat nikel, akrilik



↔ 23 cm, ↑ 12 cm, ∠ 15 cm  
incl. 1 x SMD, 7 W  
650 lm, 3.000 K



228370106



∅ 6 cm, ↑ 16,5 cm, ∠ 10 cm  
incl. 2 x SMD, 3,2 W  
2 x 300 lm, 3.000 K



222970207



↔ 6 cm, ↑ 16 cm, ∠ 9,5 cm  
incl. 2 x SMD, 3,2 W  
2 x 300 lm, 3.000 K



223070207



399

# Celia

Nickel matt, Glas matt • nickel mat, mat glass •  
nickel mat, verre mat • nikkell mat, mat glas • níquel mate, vidrio mate •  
nichel opaco, vetro sabbaiato • nichel mat, sticla mata • harjattu teräs,  
mattalasi • nikiel mat, szkło matowane • mat nikel, mat cam

**ECO**  
HALOGEN



↑ 20 cm, ↔ 19 cm, ↗ 15 cm  
incl. 1 x R7s, 80 W  
1.375 lm, 2.800 K



2606011-07



## Olivia

Nickel matt, Glas matt • nickel mat, mat glass •  
 nickel mat, verre mat • nikkell mat, mat glas • níquel mate, vidrio  
 mate • nichel opaco, vetro sabbiato • nichel mat, sticla mata •  
 harjattu teräs, mattalasi • nikiel mat, szkło matowane • mat nikel,  
 mat cam



## Marian

Nickel matt • nickel mat •  
 nickel mat • nikkell mat • níquel mate • nichel opaco •  
 nichel mat • harjattu teräs • nikiel mat • mat nikel



## Roco

Nickel matt, Acryl • nickel mat, acryl •  
 nickel mat, acryl • nikkell mat, acryl • níquel mate, acrílico •  
 nichel opaco, acrílico • nichel mat, acrylic • harjattu teräs, akryyli •  
 nikiel mat, akryl • mat nikel, akrilik



↔ 10 cm, ↓ 38 cm, ↗ 9 cm  
 incl. 1 x G9, 28 W  
 370 lm, 2.800 K



210710107



↓ 15 cm, ↔ 8 cm, ↗ 8 cm  
 incl. 2 x GU10, 35 W  
 2 x 240 lm, 2.800 K



2611021-07



↔ 24 cm, ↓ 7 cm, ↗ 11 cm  
 incl. 2 x G9, 28 W  
 2 x 370 lm, 2.800 K



212410207



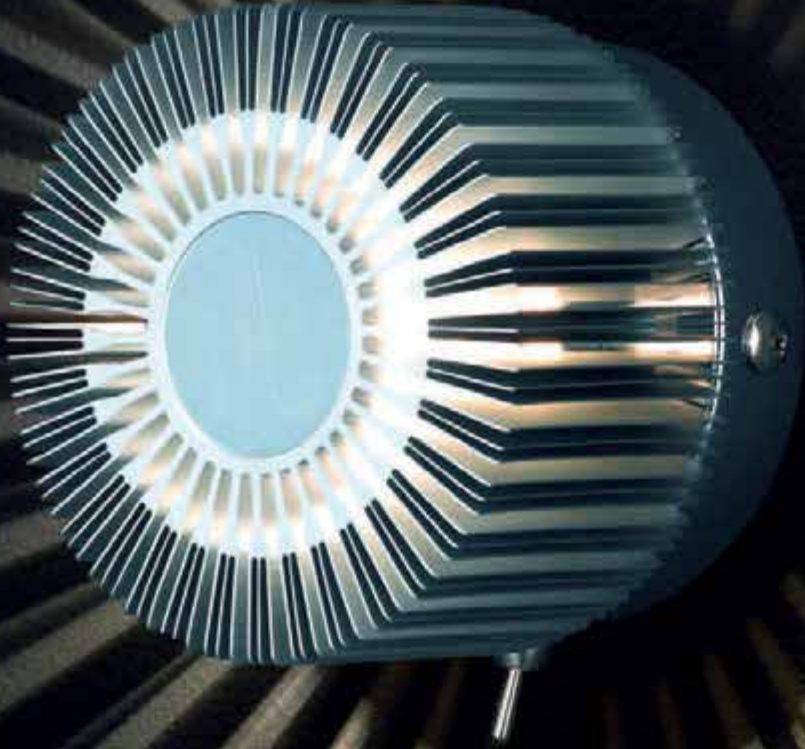

# Airlight

Aluminium • aluminium •  
aluminium • aluminium • aluminio • alluminio •  
aluminu • alumiini • aluminium • alüminyum

**ECO**  
HALOGEN

Ø 9 cm, 7 cm  
incl. 1 x G9, 18 W  
204 lm, 2.800 K



261910105



## Cono

Nickel matt oder rostfarbig, Glas • nickel mat or rusty, glass •  
 nickel mat ou rouille, verre • nikkell mat of roestkleur, glas •  
 níquel mate o óxido, vidrio • nichel opaco o ruggine, vetro •  
 nichel mat sau ruginiu, sticla • harjattu teräs tai rustiikki, lasi •  
 nikiel mat lub miedz, szkło • mat nikel veya pas, cam



## Facella

Nickel matt oder rostfarbig, Glas alabasterfarbig • nickel mat or rusty, alabaster-coloured glass •  
 nickel mat ou rouille, verre couleur albâtre • nikkell mat of roestkleur, albastkleurig glas •  
 níquel mate o óxido, vidrio de color alabastro • nichel opaco o ruggine, vetro colore alabastro •  
 nichel mat sau ruginiu, sticla culoare alabastru • harjattu teräs tai rustiikki, lasi alabasteri väri •  
 nikiel mat lub miedz, szkło alabaster kolor • mat nikel veya pas, cam kaymaktaş rengi

**ECO**  
 HALOGEN



↑ 27 cm, ↔ 5,5 cm, ↗ 10 cm  
 incl. 1 x G9, 28 W  
 370 lm, 2.800 K

↑ 35 cm, ↔ 10 cm, ↗ 15 cm  
 excl. 1 x E14, max. 60 W



216070107  
 216070124



2502211-07  
 2502211-24



**07** Nickel matt • matt nickel  
**24** rostfarbig • rusty





24

## Torcia

Nickel matt oder rostfarbig, Glas • nickel mat or rusty, glass • nickel mat ou rouille, verre • nikkel mat of roestkleur, glas • níquel mate o óxido, vidrio • nichel opaco o ruggine, vetro • nichel mat sau ruginiu, sticla • harjattu teräs tai rustiikki, lasi • nikiel mat lub miedz, szkło • mat nikel veyá pas, cam

403



↑ 80 cm, ↔ 15 cm, ↗ 18,2 cm  
excl. 1 x E14, max. 60 W

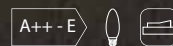

2529211-07  
2529211-24



**07** Nickel matt • matt nickel  
**24** rostfarbig • rusty



## Vita

Glas alabasterfarbig • alabaster-coloured glass •  
verre couleur albâtre • albastkleurig glas • vidrio de color alabastro •  
vetro colore alabastro • sticla culoare alabastru • lasi alabasteri väri •  
szkło alabaster kolor • cam kaymaktaşı rengi

## Miro

Glas matt • mat glass •  
verre mat • mat glas • vidrio mate • vetro sabbiato •  
sticla mata • matalasi • szkło matowane • mat cam



↑ 40 cm, ↔ 18,5 cm, ↗ 9,5 cm  
excl. 2 x E14, max. 40 W

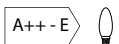

2501021-01



↑ 29 cm, ↔ 20 cm, ↗ 11 cm  
excl. 1 x E27, max. 60 W

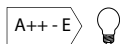

2524011-07



## Divo

chrom, Glas • chrome, glass •  
chrome, verre • chrom, glas • cromo, vidrio • cromo, vetro •  
crom, sticla • kromi, lasi • chrom, szkło • krom, cam



01



24

## Marta

chrom, Glas • chrome, glass •  
chrome, verre • chrom, glas • cromo, vidrio • cromo, vetro •  
crom, sticla • kromi, lasi • chrom, szkło • krom, cam



↔ 20 x 20 cm, ∅ 8 cm  
excl. 1 x E14, max. 40 W

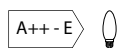

2522011-06



↔ 20 x 20 cm, ∅ 8 cm  
excl. 1 x E14, max. 40 W

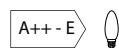

2523011-01 alabasterfarbig weiß • alabaster-coloured white  
2523011-24 alabasterfarbig amber • alabaster-coloured amber



## Inesto

Metall, Glas • metal, glass •  
 metale, verre • metaal, glas • metal, vidrio • metallo, vetro •  
 metal, sticla • metalli, lasi • metal, szkło • metal, cam



## Eudura

Metall • metal •  
 metale • metaal • metal • metallo •  
 metal • metalli • metal • metal



## Ligara

Kunststoff • plastic •  
 plastique • kunststof • plástico •  
 plastica • plastic • muovi • plastik • plastik



↓ 26 cm, ∅ max. 18 cm  
 incl. 1 x G9, 28 W  
 370 lm, 2.800 K



898470107



↓ 24,5 cm, ∅ max. 17 cm  
 incl. 1 x GU10, 35 W  
 240 lm, 2.800 K



8951211-07



↓ 28 cm, ∅ max. 20 cm  
 excl. 1 x E14, max. 40 W



8911211-07



01



19



51



87



93



## Foxi

Kunststoff, Aluminium • plastic, aluminium •  
 plastique, aluminium • kunststof, aluminium • plástico, aluminio •  
 plastica, alluminio • plastic, aluminium • muovi, alumiini •  
 plastik, aluminium • plastik, alüminyum



## Fix

Kunststoff, Aluminium • plastic, aluminium •  
 plastique, aluminium • kunststof, aluminium • plástico, aluminio •  
 plastica, alluminio • plastic, aluminium • muovi, alumiini •  
 plastik, aluminium • plastik, alüminyum



↔ 7,8 x 7,8 cm, √ 2,6 cm  
 incl. 1 x SMD, 2,8 W  
 130 lm, 3.000 K



25990



∅ 7,8 cm, √ 2,6 cm  
 incl. 1 x SMD, 2,8 W  
 130 lm, 3.000 K



25991



↔ 7,6 x 7,6 cm, √ 3,6 cm  
 incl. 1 x SMD, 2 W  
 100 lm, 3.000 K



25701 weiß • white  
 25719 türkis • turquoise  
 25751 apfelgrün • applegreen  
 25787 titanfarbig • titanium-coloured  
 25793 pink • pink

# Simeo

Kunststoff, weiß • plastic, white •  
plastique, blanc • kunststof, wit • plástico, blanco •  
plastica, bianco • plastic, alb • muovi, valkoinen •  
plastik, biały • plastik, beyaz

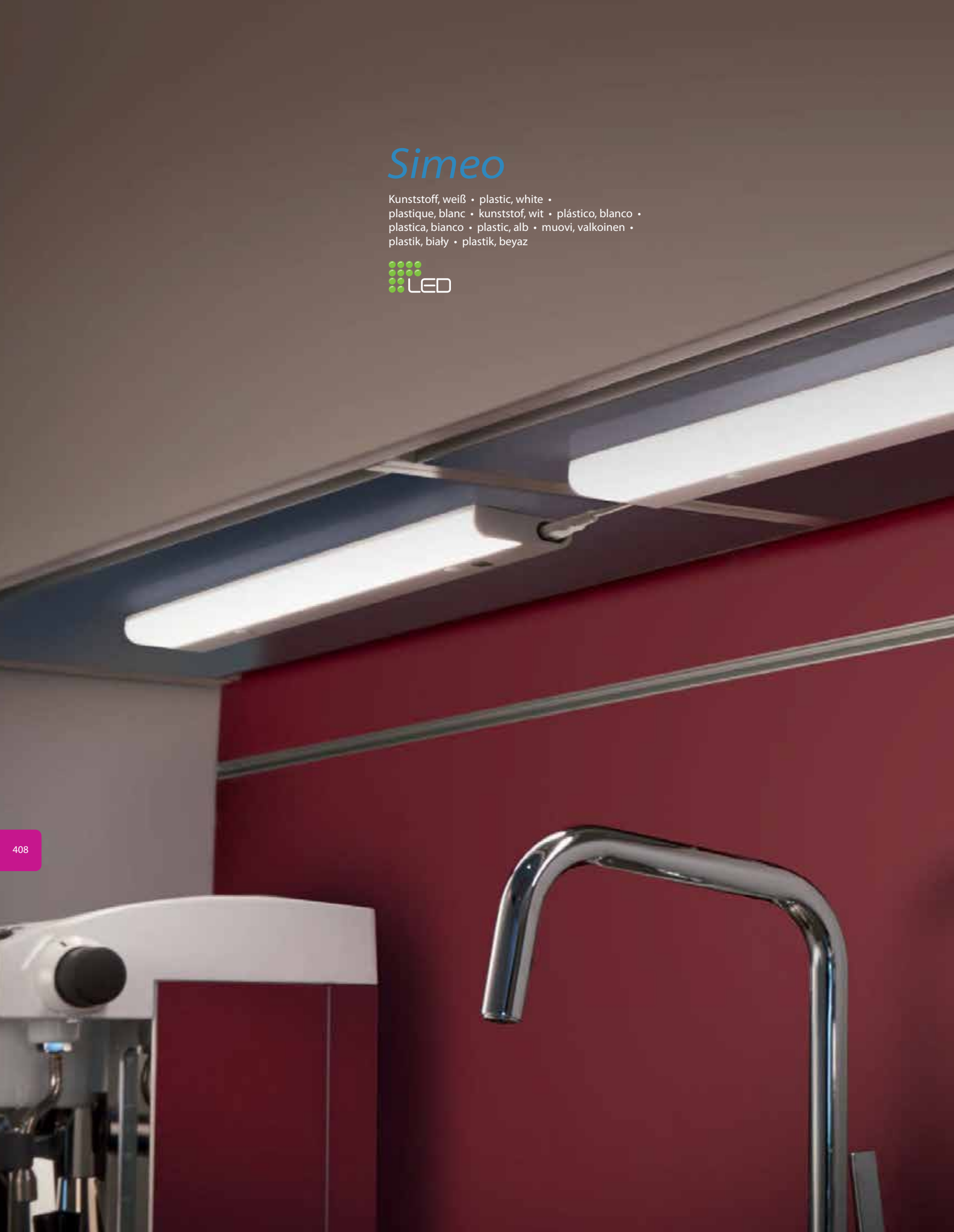





Bewegungssensor • motion sensor •  
Bewegungssensor • motion sensor • Bewegungssensor •  
motion sensor • Bewegungssensor • motion sensor •  
Bewegungssensor • motion sensor •



↔ 52,8 x 6,8 cm, ↑ 1,8 cm  
incl. SMD, 10 W  
850 lm, 3.000 K

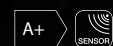

273271201



↔ 77 x 6,8 cm, ↑ 1,8 cm  
incl. SMD, 15,5 W  
1.300 lm, 3.000 K



273271801



# Mayan

Kunststoff, weiß • plastic, white •  
plastique, blanc • kunststof, wit • plástico, blanco •  
plastica, bianco • plastic, alb • muovi, valkoinen •  
plastik, biały • plastik, beyaz



↔ 53,5 x 9 cm, ↑ 4,4 cm  
incl. SMD, 10,5 W  
950 lm, 3.000 K

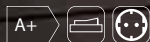

273471201

↔ 83,8 x 9 cm, ↑ 4,4 cm  
incl. SMD, 15,5 W  
1.370 lm, 3.000 K



273471801





01



87

## Aragon

Kunststoff, weiß oder titanfarbig • plastic, white or titan •  
 plastique, blanc ou titane • kunststof, wit of titaan • plástico,  
 blanco o titán • plastica, bianco o titano • plastic, alb sau titaniu •  
 muovi, valkoinen tai titaani • plastik, biały lub tytanowy • plastik,  
 beyaz veya titan



01



87

## Alino

Kunststoff, weiß oder titanfarbig • plastic, white or titan •  
 plastique, blanc ou titane • kunststof, wit of titaan • plástico,  
 blanco o titán • plastica, bianco o titano • plastic, alb sau titaniu •  
 muovi, valkoinen tai titaani • plastik, biały lub tytanowy • plastik,  
 beyaz veya titan



↔ 40 x 4 cm, ↓ 2 cm  
 incl. 3 x SMD, 1 W  
 3 x 80 lm, 3.000 K

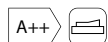

273170301  
 273170387

↔ 55 x 4 cm, ↓ 2 cm  
 incl. 4 x SMD, 1 W  
 4 x 80 lm, 3.000 K

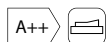

273170401  
 273170487

↔ 34 x 7 cm, ↓ 2 cm  
 incl. SMD, 4 W  
 350 lm, 3.000 K

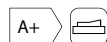

272970401  
 272970487

↔ 55 x 7 cm, ↓ 2 cm  
 incl. SMD, 7 W  
 600 lm, 3.000 K

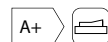

272970701  
 272970787



01 weiß • white  
 87 titanfarbig • titanium-coloured



## Ramon

Kunststoff • plastic •  
 plastique • kunststof • plástico • plastica •  
 plastic • muovi • plastik • plastik

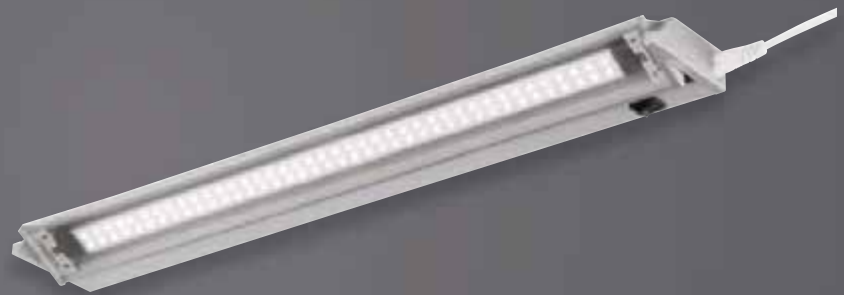

## Florian

titanfarbig, Kunststoff • titan, plastic •  
 titane, plastique • titaan, kunststof • titán, plástico •  
 titano, plastica • titaniu, plastic • titaani, muovi •  
 tytanowy, plastik • titan, plastik



↔ 28 x 2,5 cm, ↑ 4 cm  
 incl. 1 x SMD, 4 W  
 350 lm, 3.000 K



273070401



↔ 51 x 2,5 cm, ↑ 4 cm  
 incl. 1 x SMD, 7 W  
 600 lm, 3.000 K



273070701



↔ 84 x 2,5 cm, ↑ 4 cm  
 incl. 1 x SMD, 13 W  
 1.100 lm, 3.000 K



273071301



↔ 114 x 2,5 cm, ↑ 4 cm  
 incl. 1 x SMD, 18 W  
 1.500 lm, 3.000 K



273071801



↔ 57,5 cm, ↗ 8,5 cm  
 incl. 1 x SMD, 5,7 W  
 290 lm, 6.100 K



220515587





## Ecco

Nickel matt • nickel mat •  
nickel mat • nikkell mat • níquel mate • nichel opaco •  
nichel mat • harjattu teräs • nikiel mat • mat nikel



↔ 13 x 13 cm, ↑ 4 cm  
incl. 3 x SMD, 3 W  
3 x 200 lm, 3.000 K



273370307 Set: 3 St./3 pc.



# Steh- und Tischleuchten

Table- & floor lamps

Lampes de table & lampadaires

Tafel- & vloerlampen

Sobremesas y lámparas de pie

Lampade da tavolo e piantane

Veioze si lampadare

Pöytä- & lattia

Stołowe i podłogowe

Lambader & Masa lambaları

## Beijing

Nickel matt, Glas • nickel mat, glass •  
nickel mat, verre • nikkell mat, glas • níquel mate, vidrio • nichel opaco, vetro •  
nichel mat, sticla • harjattu teräs, lasi • nikiel mat, szkło • mat nikel, cam

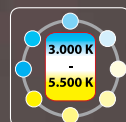

↑ 180 cm, ↗ 45 cm, Ø 48 cm  
incl. 1 x SMD, 40 W  
3.200 lm, 3.000 K  
incl. 1 x SMD, 6 W  
480 lm, 3.000 - 5.500 K



478610207





# Calgary

Nickel matt oder weiß • matt nickel or white •  
nickel mat ou blanc • nikkell mat of wit • níquel mate o blanco • nichel opaco o bianco •  
nichel mat sau alb • harjattu teräs tai valkoinen • nikiel mat lub biały • mat nikel veya beyaz



01



↓ 180 cm, ↗ 45 cm, Ø 38 cm  
incl. 1 x SMD, 30 W  
2.100 lm, 3.000 K

A

incl. 1 x SMD, 5 W  
400 lm, 3.000 K



422510201  
422510207



01 weiß • white  
07 Nickel matt • nickel mat



## Santo II

Metall, Glas alabasterfarbig • metal, alabaster-coloured glass •  
metale, verre couleur albâtre • metaal, albastkleurig glas •  
metal, vidrio de color alabastro • metallo, vetro colore alabastro •  
metal, sticla culoare alabastru • metalli, lasi alabasteri väri •  
metal, szkło alabaster kolor • metal, cam kaymaktaşı rengi



↑ 180 cm, Ø 25,5 cm, √ 40 cm  
incl. 4 x SMD, 4,5 W, 4 x 400 lm, 3.000 K  
incl. 1 x SMD, 4,5 W, 400 lm, 3.000 K



421910207  
421910228

07 Nickel matt • nickel mat  
28 rostfarbig antik • antique rust

## Arizona

Nickel matt oder Messing matt • nickel mat or brass mat •  
nickel mat ou laiton mat • nikkel mat of messing mat •  
níquel mate o bronce mate • nichel opaco o ottone satinato •  
níchel mat sau bronz mat • harjattu teräs tai mattamessinki •  
nikiel mat lub mosiądz mat • mat nikel veya mat pirinç



↓ 180 cm, Ø 25,5 cm, ∇ 40 cm  
incl. 1 x SMD, 20 W, 1.650 lm, 3.000 K  
incl. 1 x SMD, 5 W, 460 lm, 3.000 K

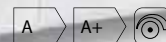

426410207  
426410208

**07** Nickel matt • nickel mat  
**88** Messing matt • matt brass



## Arango

Nickel matt oder altmessing • nickel mat or old brass •  
nickel mat ou laiton fumé • nikkel mat of oud brons • níquel  
mate o bronze viejo • nichel opaco o ottone invecchiato • nichel  
mat sau bronz antic • harjattu teräs tai antiikkimessinki • nikiel  
mat lub patyna • mat nikel veya antik piring



420



↑ 180 cm, Ø 31 cm  
incl. 1 x SMD, 20 W  
1.750 lm, 3.000 K



429110104  
429110107



**04** altmessing • old brass  
**07** Nickel matt • nickel mat





## Evans

chrom, schwarz • chrome, black •  
 chrome, noir • chroom, zwart • cromo, negro •  
 cromo, nero • crom, negru • kromi, musta •  
 chrom, czarny • krom, siyah

**ECO**  
 HALOGEN



## Lopez

Nickel matt, Glas satiniert • nickel mat, satinated glass •  
 nickel mat, verre satiné • nikkel mat, gesatineerd glas •  
 níquel mate, vidrio satinado • nichel opaco, vetro  
 satinato • nichel mat, sticla satinata • harjattu teräs,  
 satinoitu lasi • nikiel mat, szkło satynowe •  
 mat nikel, satin cam

**ECO**  
 HALOGEN



↓ 180 cm, ↔ 32 cm, ↗ 60 cm  
 incl. 1 x R7S, 230 W  
 4.650 lm, 2.800 K  
 incl. 1 x G9, 28 W  
 370 lm, 2.800 K



4348021-06



↓ 180 cm, Ø 30 cm, ↗ 50 cm  
 incl. 1 x R7S, 230 W  
 4.650 lm, 2.800 K  
 incl. 1 x G9, 28 W  
 370 lm, 2.800 K



438410207



## Santo

Metall, Glas alabasterfarbig • metal, alabaster-coloured glass •  
metale, verre couleur albâtre • metaal, albastkleurig glas •  
metal, vidrio de color alabastro • metallo, vetro colore alabastro •  
metal, sticla culoare alabastru • metalli, lasi alabasteri väri •  
metal, szkło alabaster kolor • metal, cam kaymaktaşı rengi

**ECO**  
HALOGEN

422



↑ 180 cm, Ø 25,5 cm, √ 40 cm  
incl. 1 x R7S, 230 W  
4.650 lm, 2.800 K  
incl. 1 x G9, 28 W  
370 lm, 2.800 K



431912107  
431912108  
431912124



**07** Nickel matt • nickel mat  
**08** Messing matt • brass mat  
**24** rostfarbig • rusty



## Como

Metall, Glas amber oder Glas matt •  
 metal, glass amber or mat glass •  
 metale, verre ambre ou verre mat • metaal, glas amber of mat  
 glas • metal, vidrio ámbar o vidrio mate • metallo, vetro ambra o  
 vetro sabbato • metal, sticla amber sau sticla mata • metalli, lasi  
 meripihka tai mattalasi • metal, szkło bursztynowy lub szkło  
 matowane • metal, cam amber veyá mat cam

**ECO**  
 HALOGEN



## Casco

rostfarbig, Scavo glas • rusty, scavo glass •  
 rouille, verre scavo • roestkleur, scavo glas • óxido, vidrio scavo •  
 ruggine, vetro scavo • ruginiu, sticla scavo • rustiikki, scavo-lasi •  
 miedź, szkło scavo • pas, scavo cam

**ECO**  
 HALOGEN



↓ 180 cm, Ø 31 cm, ∇ 43 cm  
 incl. 1 x R7S, 230 W  
 4.650 lm, 2.800 K  
 incl. 1 x G9, 28 W  
 370 lm, 2.800 K



4344021-24



↓ 180 cm, Ø 32 cm, ∇ 50 cm  
 incl. 1 x R7S, 230 W  
 4.650 lm, 2.800 K  
 incl. 1 x G9, 28 W  
 370 lm, 2.800 K



436410208  
 436410224



**08** Messing matt • brass mat  
**24** rostfarbig • rusty



## Florestan

Nickel matt • nickel mat •  
nickel mat • nikkell mat • níquel mate • nichel opaco •  
nichel mat • harjattu teräs • nikiel mat • mat nikel



424



↓ 180 cm, Ø 32,5 cm, ↗ 100 cm  
incl. 4 x SMD, 4,5 W  
4 x 400 lm, 3.000 K



429910107



# Seattle

Nickel matt, Glas satiniert • nickel mat, satinated glass •  
nickel mat, verre satiné • nikkell mat, gesatineerd glas • níquel  
mate, vidrio satinado • nichel opaco, vetro satinato • nichel mat,  
sticla satinata • harjattu teräs, satinoitu lasi • nikiel mat, szkło  
satynowe • mat nikel, satin cam

LED

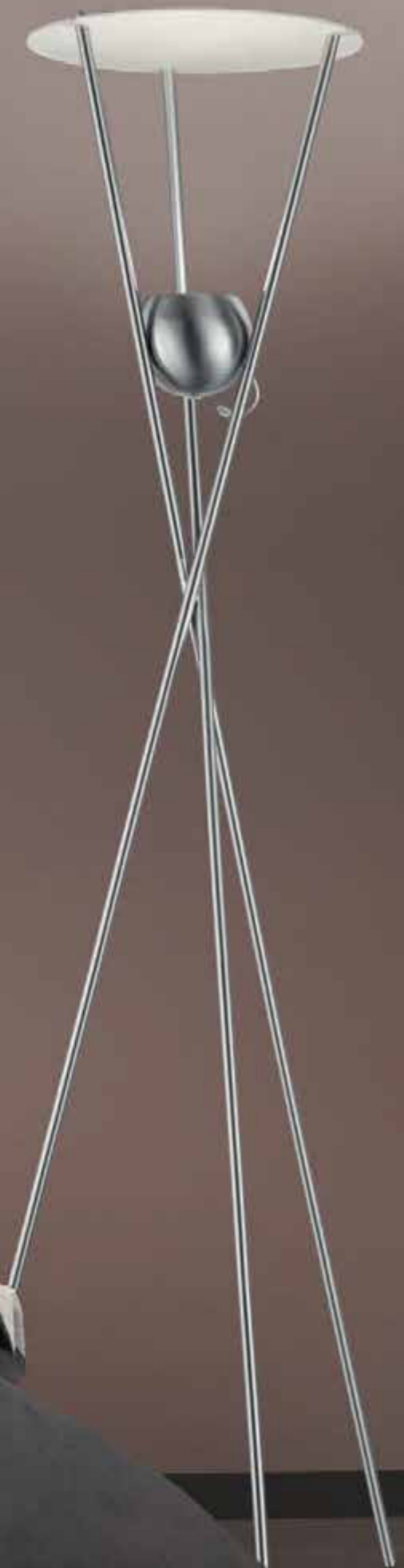

↑ 180 cm, ↔ 60 cm  
incl. 1 x SMD, 20 W  
1.800 lm, 3.000 K



424290107



01

02

87

426

# Shanghai

Metall • metal •  
metale • metaal • metallo • metal • metalli • metal • metal



↑ 210 cm, ↔ 65 cm, ↗ 200 cm  
incl. SMD, 18 W  
1.800 lm, 3.000 K



427511801  
427511802  
427511887

**01** weiß • white  
**02** schwarz • black  
**87** titanfarbig • titan





## Perez

chrom, Marmor, Stoff chrome, marble, fabric •  
 chrome, marbre, tissu • chroom, marmer, textiel •  
 cromo, mármol, tela • cromo, marmo, tessuto • crom, marmura,  
 textil • kromi, marmori, tekstiili • chrom, marmur, tkanina •  
 krom, mermer, kumaş



↑ 180 - 205 cm, ↗ 180 cm, Ø 50 cm  
 excl. 3 x E27, max. 60 W



421100301  
 421100302



**01** weiß • white  
**02** schwarz • black



# Sola

chrom, Marmor, Acryl • chrome, marble, acryl •  
chrome, marbre, acryl • chroom, marmer, acryl •  
cromo, mármol, acrílico • cromo, marmo, acrílico •  
crom, marmura, acrílic • kromi, marmori, akryyli •  
chrom, marmur, akryl • krom, mermer, akrilik

429



↑ 180 - 210 cm, ↗ 160 cm, Ø 40 cm  
excl. 1 x E27, max. 75 W

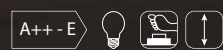

4200011-06



↓ 200 cm, ↗ 175 cm, Ø 41 cm  
excl. 1 x E27, max. 60 W

A++ - E



461200101  
461200102  
461200142

01 weiß • white  
02 schwarz • black  
42 anthrazit • anthracite



## Colorit

chrom, Stoff • chrome, fabric •  
chrome, tissu • chroom, textiel • cromo, tela • cromo, tessuto •  
crom, textil • kromi, tekstiili • chrom, tkanina • krom, kumaş

# Landor

Metall, Stoff • metal, fabric •  
metale, tissu • metaal, textiel • metal, tela metallo, tessuto •  
metal, textil • metalli, tekstiili • metal, tkanina • metal, kumaş



‡ 45 cm, Ø 22 cm  
excl. 1 x E14, max. 40 W



501400101  
501400102



‡ 155 cm, Ø 35 cm  
excl. 1 x E27, max. 60 W



401400101  
401400102



**01** weiß • white  
**02** schwarz • black





# Liège

Holz, Metall • wood, metal •  
bois, métal • hout, metaal • mader, metal • di legno, metallo •  
lemn, metal • puu, metalli • drewno, metal • tahta, metal



32

31



434



↑ 120 - 160 cm, ↔ 80 cm  
excl. 1 x E27, max. 60 W

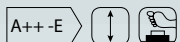

407800131  
407800132



↑ 29 cm, ↔ 22,5 cm, ↗ 28 cm  
excl. 1 x E14, max. 40 W

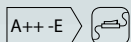

507800131  
507800132



**31** weiß matt • white matt  
**32** schwarz matt • black matt



# Antwerp

Holz, chrom • wood, chrome •  
bois, chrome • hout, chroom • mader, cromo • di legno, cromo •  
lemn, crom • puu, kromi • drewno, chrom • tahta, krom



436



↔ 80 cm, ↑ 110 - 155 cm  
excl. 1 x E27, max. 42 W



407300106



↔ 36 cm, ↑ 66 cm  
excl. 1 x E14, max. 28 W

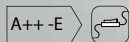

507300106







## Gent

Holz, Stoff weiß • wood, fabric white •  
bois, tissu blanc • hout, textiel wit • mader, tela blanco • di legno, tessuto bianco •  
lemn, textil alb • puu, tekstiili valkoinen • drewno, tkanina biały • tahta, kumaş beyaz



438



↔ 80 cm, ↑ 110-155 cm  
excl. 1 x E27, max. 60 W



407400101



↔ 36 cm, ↑ 67 cm  
excl. 1 x E27, max. 60 W



507400101



# Florence

Polyresin, Stoff • polyresin, fabric •  
polyresin, tissu • polyresin, textiel • polirasina, tela • poliestere, tessuto •  
polirasina, textil • polyresiini, tekstiili • polyresin, tkanina • polirezin, kumaş

02



440



↓ 142 cm, Ø 30 cm  
excl. 1 x E27, max. 60 W

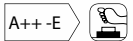

400800101  
400800102

↓ 51 cm, Ø 18 cm  
excl. 1 x E14, max. 40 W

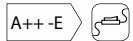

500800101  
500800102



01 weiß • white  
02 schwarz • black





01

441

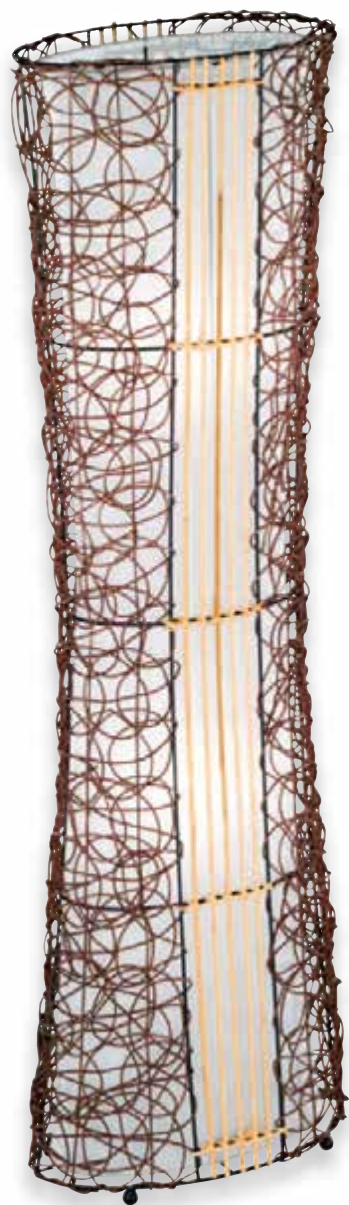

## Salim

Rattangeflecht, Stoff • rattan meshwork, fabric •  
 maillage rotin, tissu • rotan vlechtwerk, textiel •  
 malla de rattan, tela • reticolo rattan, tessuto •  
 impletitura ratan, textil • rottinki, tekstiili •  
 rattan, tkanina • örgü, kumaş



↑ 40 cm, ↔ 26 x 14,5 cm  
 excl. 1 x E14, max. 40 W



516600100



↑ 110 cm, ↔ 35,5 x 20 cm  
 excl. 2 x E14, max. 40 W



416600200







## Mons

chrom, Acryl • chrome, acryl •  
chrome, acryl • chroom, acryl • cromo, acrílico • cromo, acrílico •  
crom, acrilic • kromi, akryyli • chrom, akryl • krom, akrilik



444



↑ 160 cm, Ø 80 cm  
incl. 1 x SMD, 11 W  
1.000 lm, 3.000 K



477710106



↑ 55 cm, Ø 26 cm  
1 x SMD, 7 W  
700 lm, 3.000 K



577710106







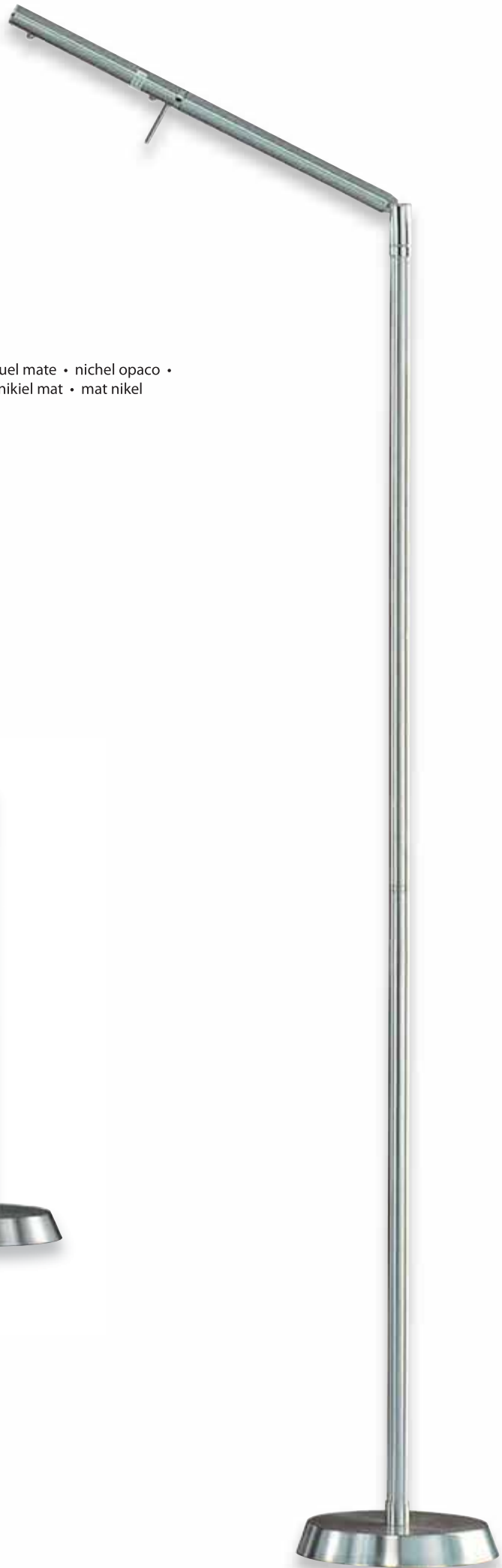

## Filigran

Nickel matt • nickel mat •  
nickel mat • nikkell mat • niquel mate • nichel opaco •  
nichel mat • harjattu teräs • nikiel mat • mat nikel



↓ 45 cm, ↗ 51 cm  
incl. 1 x SMD, 6 W  
560 lm, 3.000 K



520490107



↓ 162 cm, ↗ 52 cm  
incl. 1 x SMD, 6 W  
560 lm, 3.000 K



420490107

## Clapton

Aluminium gebürstet, chrom, Glas weiß gewischt •  
brushed aluminium, chrome, glass white brushed glass •  
aluminium balayé, chrome, verre blanc balayé • geborsteld aluminium,  
chrom, wit geborsteld glas • aluminio pulido, cromo, blanco pulido •  
alluminio spazzolato, cromo, vetro bianco spazzolato • aluminiu lucios,  
crom, alb lucios • harjattu alumiini, kromi, lasi harjattu valkoinen •  
aluminium szczotkowane, chrom, szkło białe otarła • alüminyum, krom,  
beyaz cam



↑ 145 cm, ↔ 23 cm  
incl. 3 x SMD, 4,5 W  
3 x 400 lm, 3.000 K



421410305

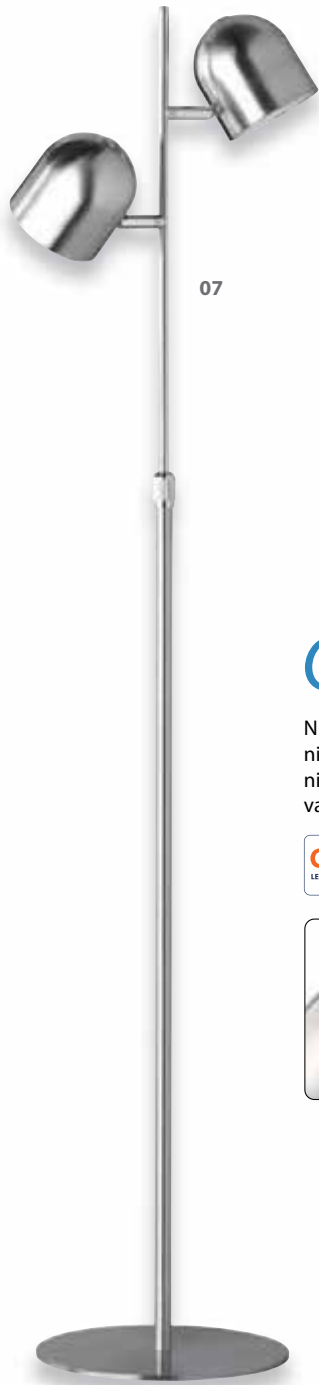

07

## Quidam

Nickel matt oder weiß • nickel mat or white •  
nickel mat ou blanc • nikkell mat of wit • níquel mate o blanco •  
nichel opaco o bianco • nichel mat sau alb • harjattu teräs tai  
valkoinen • nikiel mat lub biały • mat nikel veya beyaz

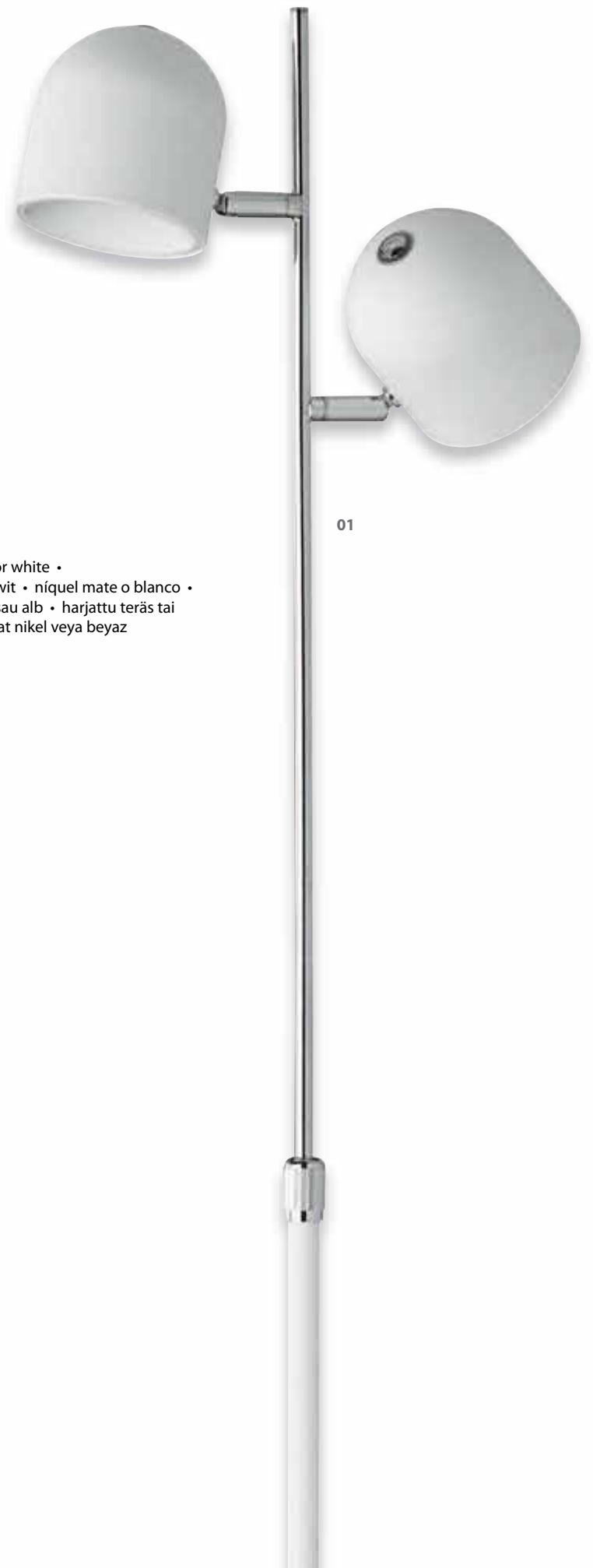

01



↑ 100 - 150 cm, Ø 23 cm  
incl. 2 x SMD, 4,5 W  
2 x 430 lm, 3.000 K



472490201  
472490207



01 weiß • white  
07 Nickel matt • nickel mat





## Zidane

chrom oder Nickel matt • chrome or nickel mat •  
chrome ou nickel mat • chroom of nikkel mat • cromo o níquel  
mate • cromo o nichel opaco • crom sau nichel mat • kromi tai  
harjattu teräs • chrom lub nikiel mat • krom veya mat nikel



↓ 145 cm, Ø 24 cm  
incl. 3 x SMD, 4,5 W  
3 x 430 lm, 3.000 K

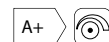

478610306  
478610307



**06** chrom • chrome  
**07** Nickel matt • nickel mat



87

# Palo

Metall • metal •  
metale • metaal • metal • metallo •  
metal • metalli • metal • metal



02

01

17



87



↓ max. 40 cm, Ø 14 cm, ∠ 25 cm  
incl. SMD, 3 W  
300 lm, 3.100 K



524510101  
524510102  
524510117  
524510187



↓ 150 cm, Ø 20 cm, ∠ 40 cm  
incl. SMD, 5 W  
480 lm, 3.100 K



424510187



**01** weiß • white  
**02** schwarz • black  
**17** mehrfarbig • multicolor  
**87** titanfarbig • titanium-coloured



07



07



06

## Palo II

Metall • metal •  
 metale • metaal • metal • metallo •  
 metal • metalli • metal • metal



↓ 40 cm, Ø 14 cm, √ 25 cm  
 incl. SMD, 3 W  
 300 lm, 3.100 K



524590106  
 524590107



↓ 130 cm, Ø 20 cm, √ 40 cm  
 incl. SMD, 5 W  
 480 lm, 3.100 K

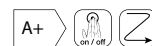

424590107



**06** chrom • chrome  
**07** Nickel matt • nickel mat



↑ 60 cm, ↗ 55 cm  
incl. 1 x SMD, 6 W  
670 lm, 3.000 K



527410101  
527410142



↑ 160 cm, ↗ 55 cm  
incl. 1 x SMD, 6 W  
670 lm, 3.000 K



427410101  
427410142



**01** weiß • white  
**42** anthrazit • anthracite





## Roderic

Nickel matt, Stoff • nickel mat, fabric •  
nickel mat, tissu • nikkel mat, textiel • níquel mate, tela •  
nichel opaco, tessuto • nichel mat, textil • harjattu teräs, tekstiili •  
nikiel mat, tkanina • mat nikel, kumaş





08

## Salido

Metall • metal •  
metale • metaal • metal • metallo •  
metal • metalli • metal • metal



04



07



07

## Icaro

Metall, Glas matt • metal, mat glass •  
metale, verre mat • metaal, mat glas •  
metal, vidrio mate • metallo, vetro  
sabbaiato • metal, sticla mata • metalli,  
mattalasi • metal, szkło matowane •  
metal, mat cam



04



08



↓ 160 cm, ↗ 55 cm  
incl. 1 x GY6,35, 50 W  
850 lm, 2.800 K



4403011-04  
4403011-07  
4403011-08



↓ 165 cm, ↗ 44 cm  
excl. 1 x E27, max. 60 W



4035011-04  
4035011-07  
4035011-08



04 altmessing • old brass  
07 Nickel matt • nickel mat  
08 Messing matt • brass mat



## Zinedine

Nickel matt, Glas matt • nickel mat, mat glass •  
 nickel mat, verre mat • nikkell mat, mat glas •  
 níquel mate, vidrio mate • nichel opaco, vetro sabbiato •  
 nichel mat, sticla mata • harjattu teräs, mattalasi •  
 nikiel mat, szkło matowane • mat nikel, mat cam

**ECO**  
 HALOGEN

## Sanero

Metall • metal •  
 metale • metaal • metal •  
 metallo • metal • metalli • metal • metal

**ECO**  
 HALOGEN

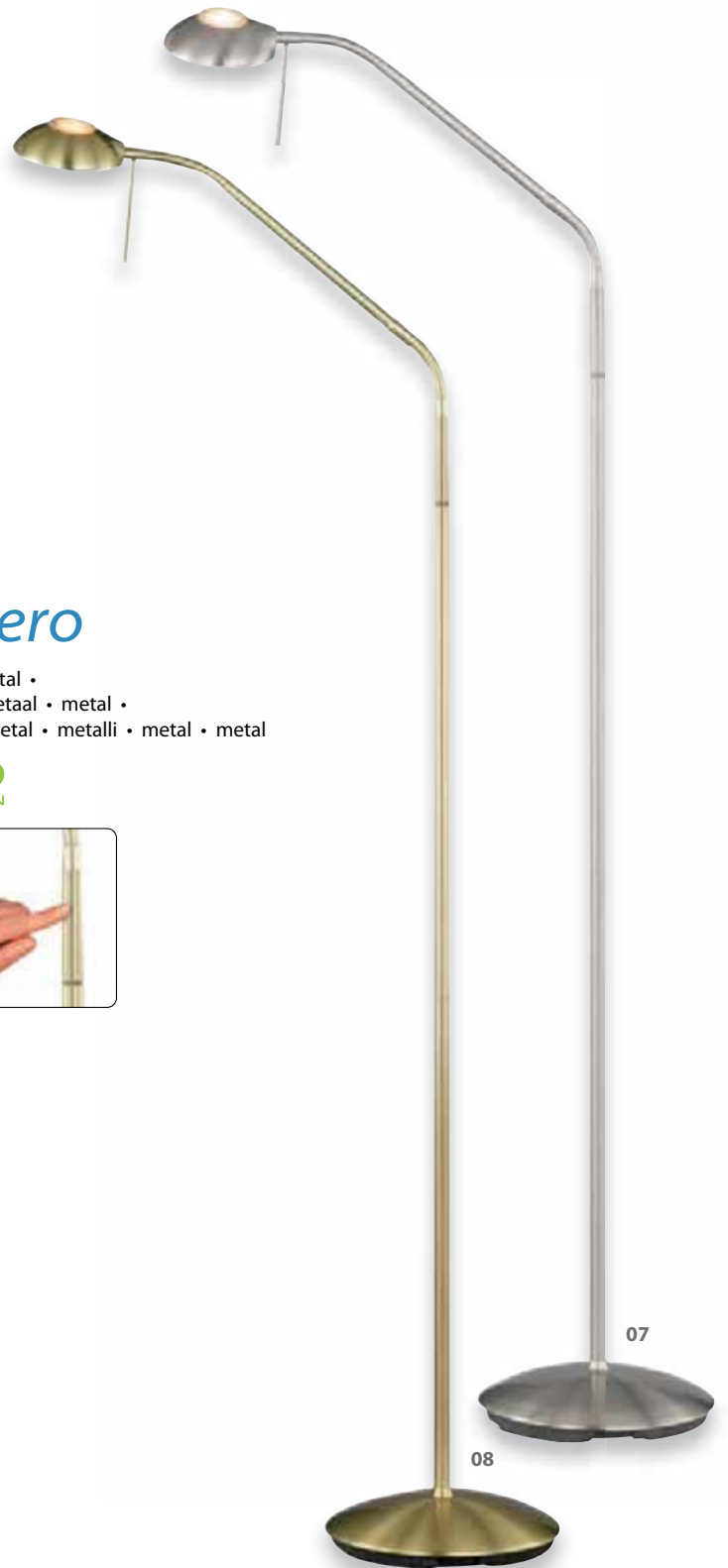

↓ 160 cm, Ø 26 cm  
 incl. 3 x G9, 28 W  
 3 x 370 lm, 2.800 K



403010307



↓ 150 cm, √ 48 cm  
 incl. 1 x G9, 28 W  
 370 lm, 2.800 K



4912011-07  
 4912011-08



07 Nickel matt • nickel mat  
 08 Messing matt • brass mat

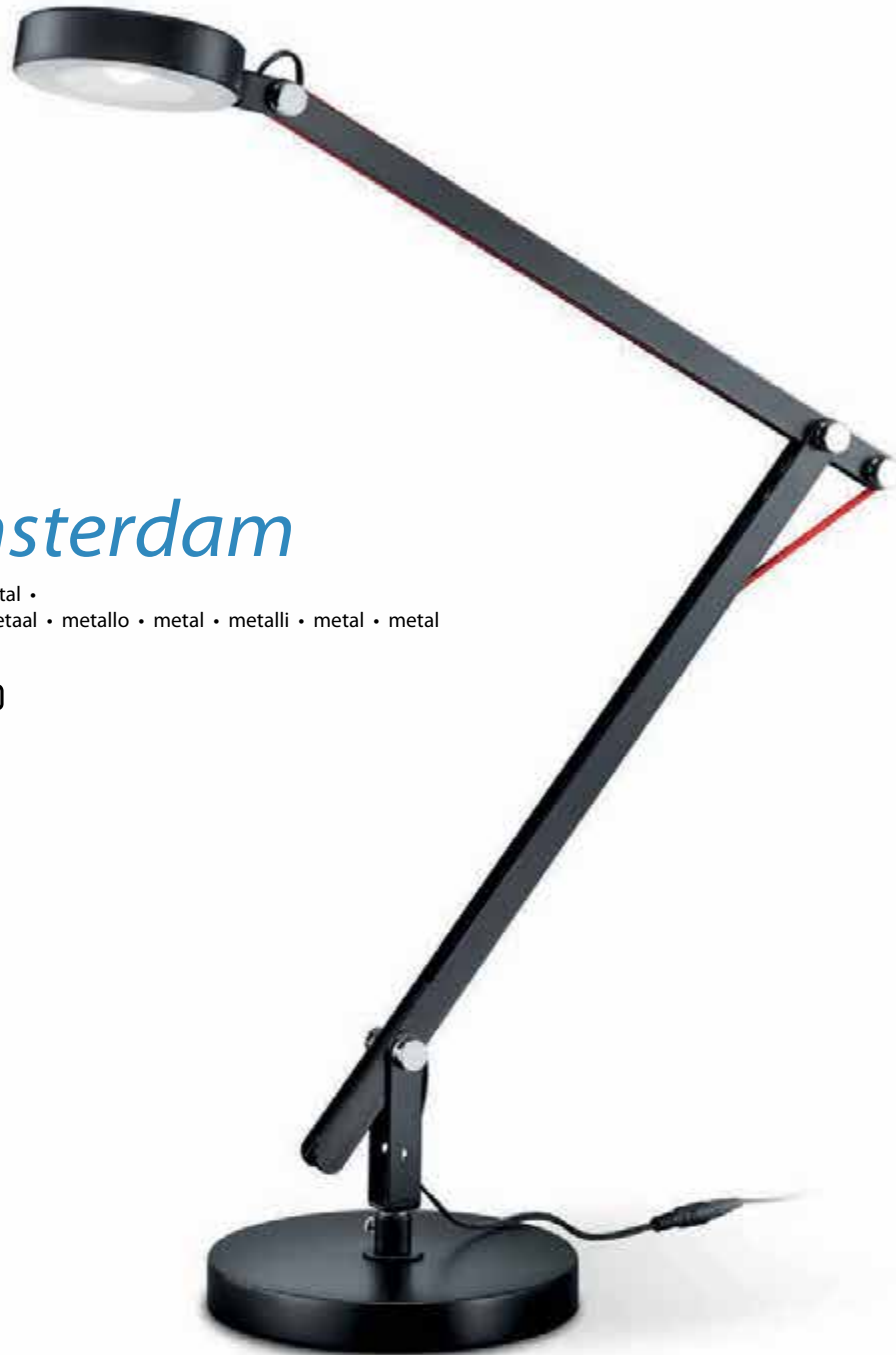

02

# Amsterdam

Metall • metal •  
metale • metaal • metallo • metal • metalli • metal • metal



456



↑ max. 90 cm, ↗ max. 90 cm, Ø 18 cm  
incl. 1 x COB, 5 W  
500 lm, 3.000 K



527920101  
527920102

01 weiß • white  
02 schwarz • black





01



01

02

## Swan

Aluminium, Kunststoff • aluminium, plastic •  
 aluminium, plastique • aluminium, kunststof • aluminio, plástico •  
 alluminio, plastica • aluminiu, plastic • alumiini, muovi •  
 aluminium, plastik • alüminyum, plastik

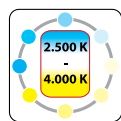

↑ 50 cm, ↔ 16 cm, ↗ 45 cm  
 incl. 1 x SMD, 7 W  
 470 lm, 2.500 - 4.000 K



523910101  
 523910102



**01** weiß • white  
**02** schwarz • black

# Miami

Kunststoff, schwarz oder titanfarbig •  
plastic, black or titan •  
plastique, noir ou titane • kunststof, zwart of titaan •  
plástico, negro o titán • plastica, nero o titano •  
plastic, negru sau titaniu • muovi, musta tai titaani •  
plastik, czarny lub tytanowy • plastik, siyah veya titan

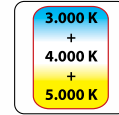

induktive Ladestation • inductive loading station •  
station de chargement inductif • inductief laadstation •  
estación de carga inductiva • stazione di carico  
induttivo • stație de încărcare inductivă • induktiivinen  
latausasema • stacja ładowania indukcyjnego •  
endüktif yükleme istasyonu

87

459

↓ 50 cm, ↔ 18 cm, ↗ 29 cm  
incl. 1 x SMD, 5 W  
600 lm, 3.000, 4.000, 5.000 K



02 schwarz • black

87 titanfarbig • titanium-coloured



570190102

570190187



## Bruno

Kunststoff, anthrazit/titanfarbig • plastic, anthracite/titan •  
 plastique, antracite/titane • kunststof, antraciet/titaan •  
 plástico, antracita/titán • plastica, antracite/titano •  
 plastic, antracit/titanium • muovi, antrasiitti/titaani •  
 plastik, antracyt/tytanowy • plastik, antrasit/titan



## Loris

Kunststoff, titanfarbig • plastic, titan •  
 plastique, titane • kunststof, titaan • plástico, titán •  
 plastica, titano • plastic, titaniu • muovi, titaani •  
 plastik, tytanowy • plastik, titan

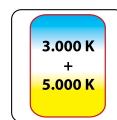

↓ 75 cm, ↔ 21 cm, ↗ 52 cm  
 incl. 1 x SMD, 7 W  
 600 lm, 4.100 K



525110142



↓ 45 cm, ↔ 12 cm, ↗ 47 cm  
 incl. 1 x SMD, 5,5 W  
 500 lm, 3.000 K + 5.000 K



526290187



# Brentano

Kunststoff • plastic •  
plastique • kunststof • plástico •  
plastica • plastic • muovi • plastik • plastik



↑ max. 50 cm, Ø 18 cm, √ 51 cm  
incl. 1 x SMD, 5 W  
500 lm, 3.000 K



526410101  
526410102  
526410187



01 weiß • white  
02 schwarz • black  
87 titanfarbig • titanium-coloured



## Arko

Kunststoff • plastic •  
 plastique • kunststof • plástico •  
 plastica • plastic • muovi • plastik • plastik

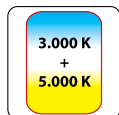

## Lucio

Kunststoff • plastic •  
 plastique • kunststof • plástico •  
 plastica • plastic • muovi • plastik • plastik



↑ 50 cm, ↔ 13 cm, ↗ 45 cm  
 incl. 1 x SMD, 7 W  
 600 lm, 4.100 K



523410101

523410187

↑ 35 cm, ↔ 28 x 14 cm, ↗ 43 cm  
 incl. 1 x SMD, 4 W  
 1 x 360 / 400 lm, 3.000 K / 5.000 K



577390101

577390102

577390187

**01** weiß • white

**02** schwarz • black

**87** titanfarbig • titanium-coloured



## Baco

Kunststoff • plastic •  
 plastique • kunststof • plástico •  
 plastica • plastic • muovi • plastik • plastik



## Polly

Kunststoff • plastic •  
 plastique • kunststof • plástico •  
 plastica • plastic • muovi • plastik • plastik



↑ 40 cm, Ø 17 cm, ↗ 50 cm  
 incl. 1 x COB, 5 W  
 450 lm, 3.000 K



526610101



↑ 40 cm, ↔ 16 x 16 cm, ↗ 39 cm  
 incl. 1 x SMD, 4,8 W  
 450 lm, 3.000 K



573910101  
 573910102  
 573910106

**01** weiß • white  
**02** schwarz • black  
**06** chrom • chrome



## Lupo

Kunststoff • plastic •  
 plastique • kunststof • plástico •  
 plastica • plastic • muovi • plastik • plastik



↑ 35 cm, Ø 13,5 cm, ∠ 30 cm  
 incl. 1 x SMD, 5 W  
 550 lm, 3.500 K



527290101  
 527290102



↑ 35 cm, Ø 13,5 cm, ∠ 30 cm  
 incl. 1 x SMD, 5 W  
 550 lm, 3.500 K

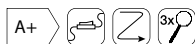

227280101  
 227280102



**01** weiß • white  
**02** schwarz • black





Grundlagen der Optik

Formeln der geometrischen Optik  
den Vergleich ähnlicher  
der Darstellung der optischen  
Zustandsverhältnisse ergibt  
Fundamenten der geometrischen  
Abbildungslehre  
DOP und MOFF alle  
D und O recht  
M gilt  
folgende

Der Abbildungsmaßstab  
Verhältnis der  
der Bildgröße  
ist, in welchem Ver  
ist auf der Filmben

Abbildungsmäßig ist das Verhältnis zwischen  
der Abbildung und der Größe  
des Gegenstandes. Ein Maßstab von 1:1  
bedeutet, dass die Abbildung die gleiche Größe  
wie der Gegenstand hat. Ein Maßstab von 1:2  
bedeutet, dass die Abbildung die Hälfte der  
Größe des Gegenstandes hat. Ein Maßstab von 2:1  
bedeutet, dass die Abbildung doppelt so groß  
wie der Gegenstand ist. Ein Maßstab von 1:n  
bedeutet, dass die Abbildung n-mal so groß  
wie der Gegenstand ist. Ein Maßstab von n:1  
bedeutet, dass die Abbildung n-mal so klein  
wie der Gegenstand ist. Ein Maßstab von 1:1  
bedeutet, dass die Abbildung die gleiche Größe  
wie der Gegenstand hat. Ein Maßstab von 1:2  
bedeutet, dass die Abbildung die Hälfte der  
Größe des Gegenstandes hat. Ein Maßstab von 2:1  
bedeutet, dass die Abbildung doppelt so groß  
wie der Gegenstand ist. Ein Maßstab von 1:n  
bedeutet, dass die Abbildung n-mal so groß  
wie der Gegenstand ist. Ein Maßstab von n:1  
bedeutet, dass die Abbildung n-mal so klein  
wie der Gegenstand ist.

Abbildungsverhältnis  
das kleinere Glied  
Zwar weniger bi  
rechnerische Zwer  
erlaubt, ist die  
Maßstabes ab

Praxis wissen  
um so größer  
je kleiner die Aufnah  
bei gleich  
je länger  
Wenn wir  
gleichbleib

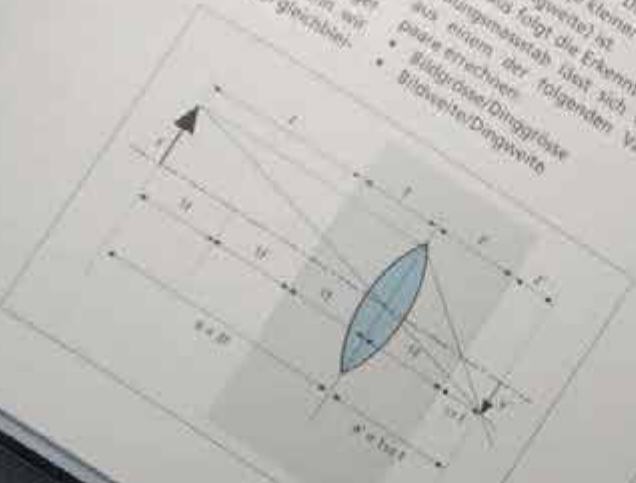

Aufnahmestandpunkt ein OR  
einholen, machen wir nichts  
als die Brennweite verlängern  
den Abbildungsmaßstab ver  
Well der Bildausschnitt des  
unverformt dabei gleich bleibt  
wie lediglich einen Ausschnitt  
größerem Bildes  
hängt sowohl von der Aufnah  
als auch von der Objekt  
Aus Erfahrung und aus den bishe  
gen Betrachtungen wissen wir, dass die  
Kamerazaug (die Bildweite) gleich  
groß ist wie die Brennweite, wenn sich  
der Aufnahmegegenstand unendlich  
weit weg befindet. Die Bildweite wird  
um so größer, je kleiner die Aufnahme  
distanz (Dingweite) ist.  
Daraus folgt die Erkenntnis: Der Ab  
bildungsmaßstab lässt sich wahlweise  
aus einem der folgenden Variablen  
paare errechnen  
• Bildgröße/Dinggröße  
• Bildweite/Dingweite



## Toledo

Metall • metal •  
metale • metaal • metal • metallo •  
metal • metalli • metal • metal

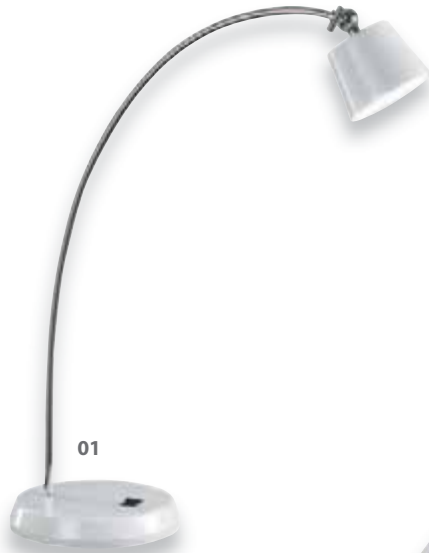

## Pareto

chrom • chrome •  
chrome • chroom • cromo • cromo •  
crom • kromi • chrom • krom



↑ 35 cm, Ø 23 cm  
incl. COB, 5 W  
300 lm, 3.000 K



524910106



↑ 35 cm, ∇ 27 cm  
incl. COB, 5 W  
320 lm, 3.000 K



522610101  
522610187



**01** weiß • white  
**87** titanfarbig • titanium-coloured



87

01

## Vario

Metall, Kunststoff • metal, plastic •  
 metale, plastique • metaal, kunststof • metal, plástico •  
 metallo, plastica • metal, plastic • metalli, muovi •  
 metal, plastik • metal, plastik

LED



02



↑ max. 64,5 cm, ↗ max. 50 cm  
 incl. SMD, 3,6 W  
 200 lm, 3.000 K



- 01 weiß • white
- 02 schwarz • black
- 87 titanfarbig • titanium-coloured

522520101  
 522520102  
 522520187





## Preto

Metall, Kunststoff • metal, plastic •  
 metale, plastique • metaal, kunststof • metal,  
 plástico • metallo, plastica • metal, plastic •  
 metalli, muovi • metal, plastik • metal, plastik



## Nadir

Kunststoff • plastic •  
 plastique • kunststof • plástico •  
 plastica • plastic • muovi • plastik • plastik



↓ max. 40 cm, ↗ 25 cm  
 incl. SMD, 3,8 W  
 350 lm, 3.100 K



528310102  
 528310107



↓ max. 40 cm, ↗ 40 cm  
 incl. SMD, 3,8 W  
 350 lm, 3.100 K



528380107



↓ 23 - 40 cm, ↔ 12 x 12 cm, ↗ 35 cm  
 incl. SMD, 3 W  
 320 lm, 3.000 K

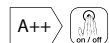

573510101  
 573510102  
 573510115  
 573510187



01 weiß • white  
 02 schwarz • black  
 07 Nickel matt • nickel mat  
 15 grün • green  
 87 titanfarbig • titanium-coloured



# Kolibri

Metall, Kunststoff • metal, plastic •  
 metals, plastique • metaal, kunststof • metal, plástico •  
 metallo, plastica • metal, plastic • metalli, muovi •  
 metal, plastik • metal, plastik

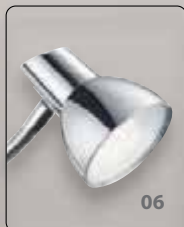

↑ 35 cm, ↗ 32 cm  
 incl. 1 x SMD, 4,4 W  
 450 lm, 3.000 K



527810101  
 527810106  
 527810107  
 527810115  
 527810119



**01** weiß • white  
**06** chrom • chrome  
**07** Nickel matt • matt nickel  
**15** grün • green  
**19** türkis • turquoise



## Tajo

Metall • metal •  
metale • metaal • metal • metallo •  
metal • metalli • metal • metal

47



17

01



17



01

02

47

## Flexo

Metall, Kunststoff • metal, plastic •  
metale, plastique • metaal, kunststof • metal, plástico •  
metallo, plastica • metal, plastic • metalli, muovi •  
metal, plastik • metal, plastik



↑ 73,5 cm, ↗ 51 cm  
excl. 1 x E27, max. 40 W



5029010-01 weiß • white  
5029010-17 mehrfarbig • multicolor  
5029010-47 anthrazit • anthracite



↑ 30 cm, ↗ 30 cm  
excl. 1x E14, max. 18 W



5028010-01 weiß • white  
5028010-02 schwarz • black  
5028010-17 mehrfarbig • multicolor  
5028010-47 silberfarbig • silver-coloured



47



01



17

## Pronto

Metall, Kunststoff • metal, plastic •  
 metale, plastique • metaal, kunststof • metal, plástico •  
 metallo, plastica • metal, plastic • metalli, muovi •  
 metal, plastik • metal, plastik



87

42

## Pirlo

Kunststoff, Metall • plastic, metal •  
 plastique, metale • kunststof, metaal • plástico, metal •  
 plastica, metallo • plastic, metal • muovi, metalli •  
 plastik, metal • plastik, metal



↓ 30 cm, ↗ 22 cm  
 excl. 1 x E27, max. 18 W



↓ 53,5 cm, ↗ 50 cm  
 incl. 1 x GY 6,35, 50 W  
 850 lm, 2.800 K



5027011-01 weiß • white  
 5027011-17 mehrfarbig • multicolor  
 5027011-47 silberfarbig • silver-coloured



5410011-42 anthrazit • anthracite  
 5410011-87 titanfarbig • titanium-coloured



## Ventura

Metall, Glas matt • metal, mat glass •  
metale, verre mat • metaal, mat glas • metal, vidrio mate •  
metallo, vetro sabbiato • metal, sticla mata • metalli, mattalasi •  
metal, szkło matowane • metal, mat cam



↓ 28 cm, Ø 15,5 cm  
incl. 1 x SMD, 5 W  
400 lm, 3.000 K



529990103  
529990106  
529990107  
529990124



03 Messing poliert • polished brass  
06 chrom • chrome  
07 Nickel matt • matt nickel  
24 rostfarbig • rusty



# Pear

chrom, Nickel matt, Glas opal • chrome, nickel mat, opal glass •  
chrome, nickel mat, verre opale • chrom, nikkell mat, opaal glas •  
cromo, níquel mate, vidrio opal • cromo, nichel opaco, vetro opale •  
crom, nichel mat, sticla opala • kromi, harjattu teräs, opaallasi •  
chrom, nikiel mat, szkło opal • krom, mat nikel, opal cam



↑ 32 cm, Ø 18 cm  
incl. SMD, 5 W  
350 lm, 3.000 K

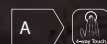

528990506



↑ 43 cm, Ø 20 cm  
incl. SMD, 8 W  
600 lm, 3.000 K

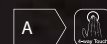

528990806

# Parabol

Aluminium gebürstet, chrom • brushed aluminium, chrome •  
aluminium balayé, chrome • geborsteld aluminium, chroom •  
aluminio pulido, cromo • alluminio spazzolato, cromo •  
aluminium lucios, crom • harjattu alumiini, kromi •  
aluminium szczotkowane, chrom • alüminyum, krom



474



↑ 48 cm, Ø 18 cm  
incl. SMD, 7,5 W  
550 lm, 3.500 K



572711005



## Cristo

chrom oder Nickel matt, Glas • chrome or nickel mat, glass •  
 chrome ou nickel mat, verre • chrom of nikkell mat, glas •  
 cromo o níquel mate, vidrio • cromo o nichel opaco, vetro •  
 crom sau nichel mat, sticla • kromi tai harjattu teräs, lasi •  
 chrom lub nikiel mat, szkło • krom veyá mat nikel, cam



28



03



06



07

## Monti

Metall, Glas • metal, glass •  
 metale, verre • metaal, glas • metal, vidrio • metallo, vetro •  
 metal, sticla • metalli, lasi • metal, szkło • metal, cam



LED E14, 4 W  
 320 lm, 3.000 K

A+

983-40



‡ 15 cm, Ø 11 cm  
 incl. 1 x SMD, 4,5 W  
 400 lm, 3.000 K



529690100  
 529690106  
 529690107



‡ 25,5 cm, Ø 15 cm  
 incl. 1 x SMD, 4 W  
 320 lm, 3.000 K

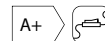

529310103  
 529310106  
 529310107  
 529310128



00 transparent • transparent  
 03 Messing poliert • polished brass  
 06 chrom • chrome  
 07 Nickel matt • matt nickel  
 28 rostfarbig antik • antique rust

## Henk

Metall, Glas alabasterfarbig • metal, alabaster-coloured glass •  
metale, verre couleur albâtre • metaal, albastkleurig glas • metal,  
vidrio de color alabastro • metallo, vetro colore alabastro • metal,  
sticla culoare alabastru • metalli, lasi alabasteri väri • metal, szkło  
alabaster kolor • metal, cam kaymaktaşı rengi



24



07

04

08

476



↑ 38 cm, Ø 26 cm  
excl. 1 x E14, max. 40 W



5925011-04  
5925011-07  
5925011-08  
5925011-24



04 altmessing • old brass  
07 Nickel matt • nickel mat  
08 Messing matt • brass mat  
24 rostfarbig • rusty





24

01

## Gerrit

Metall, Glas alabasterfarbig •  
 metal, alabaster-coloured glass •  
 metale, verre couleur albâtre • metaal, albastkleurig  
 glas • metal, vidrio de color alabastro • metallo,  
 vetro colore alabastro • metal, sticla culoare  
 alabastru • metalli, lasi alabasteri väri • metal, szkło  
 alabaster kolor • metal, cam kaymaktaşl rengi



## Eik

Nickel matt, Glas matt • nickel mat, mat glass •  
 nickel mat, verre mat • nikkell mat, mat glas •  
 níquel mate, vidrio mate • nichel opaco, vetro sabbato •  
 nichel mat, sticla mata • harjattu teräs, mattalasi •  
 nikiel mat, szkło matowane • mat nikel, mat cam



↓ 31 cm, Ø 19 cm  
 excl. 1 x E14, max. 40 W



5949011-07



↓ 25 cm, Ø 15 cm  
 excl. 1 x E14, max. 40 W



5930011-01  
 5930011-24



## Fynn

Metall, Glas alabasterfarbig • metal, alabaster-coloured glass •  
 metale, verre couleur albâtre • metaal, albastkleurig glas •  
 metal, vidrio de color alabastro • metallo, vetro colore alabastro •  
 metal, sticla culoare alabastru • metalli, lasi alabasteri väri •  
 metal, szkło alabaster kolor • metal, cam kaymaktaşı rengi



## Rey

Metall, Glas • metal, glass •  
 metale, verre • metaal, glas • metal, vidrio • metallo, vetro •  
 metal, sticla • metalli, lasi • metal, szkło • metal, cam



↑ 21 cm, Ø 15 cm  
 excl. 1 x E14, max. 40 W



599000106  
 599000107  
 599000108  
 599000118  
 599000124



↑ 36 cm, Ø 12 cm  
 excl. 1 x E14, max. 40 W



5950011-07  
 5950011-18



06 chrom • chrome  
 07 Nickel matt • nickel mat  
 08 Messing matt • brass mat  
 18 orange • orange  
 24 rostfarbig • rusty

## Joost

Nickel matt, Glas matt • nickel mat, mat glass •  
nickel mat, verre mat • nikkell mat, mat glas •  
níquel mate, vidrio mate • nichel opaco, vetro  
sabbaiato • nichel mat, sticla mata • harjattu teräs,  
mattalasi • nikiel mat, szkło matowane •  
mat nikel, mat cam



479



↑ 39 cm, Ø 19 cm  
excl. 1 x E27, max. 60 W



5922011-07



## Luis

Metall, Glas alabasterfarbig • metal, alabaster-coloured glass •  
 metale, verre couleur albâtre • metaal, albastkleurig glas •  
 metal, vidrio de color alabastro • metallo, vetro colore alabastro •  
 metal, sticla culoare alabastru • metalli, lasi alabasteri väri •  
 metal, szkło alabaster kolor • metal, cam kaymaktaşı rengi



↑ 32 cm, Ø 12  
 excl. 1 x E14, max. 40 W



595500106  
 595500107  
 595500108  
 595500124

**06** chrom • chrome  
**07** Nickel matt • nickel mat  
**08** Messing matt • brass mat  
**24** rostfarbig • rusty



# Morten

Metall, Glas alabasterfarbig • metal, alabaster-coloured glass •  
 metale, verre couleur albâtre • metaal, albastkleurig glas •  
 metal, vidrio de color alabastro • metallo, vetro colore alabastro •  
 metal, sticla culoare alabastru • metalli, lasi alabasteri väri •  
 metal, szkło alabaster kolor • metal, cam kaymaktaşı rengi

**ECO**  
 HALOGEN



07



08



# Ary

Nickel matt, Glas matt • nickel mat, mat glass •  
 nickel mat, verre mat • nikkell mat, mat glas •  
 níquel mate, vidrio mate • nichel opaco, vetro sabbbiato •  
 nichel mat, sticla mata • harjattu teräs, mattalasi •  
 nikiel mat, szkło matowane • mat nikel, mat cam



↔ 15 x 8 cm, ↓ 18,5 cm  
 incl. 1 x G9, 28 W  
 370 lm, 2.800 K



592000107  
 592000108



↓ 15 cm, Ø 9 cm  
 excl. 1 x E14, max. 40 W

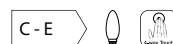

5908011-07



07 Nickel matt • nickel mat  
 08 Messing matt • brass mat



## Tubo

Nickel matt, Glas • nickel mat, glass •  
 nickel mat, verre • nikkell mat, glas • níquel mate, vidrio •  
 nichel opaco, vetro • nichel mat, sticla • harjattu teräs, lasi •  
 nikiel mat, szkło • mat nikel, cam



07



03



06



28

## Seta

Metall, Glas • metal, glass •  
 metale, verre • metaal, glas • metal, vidrio •  
 metallo, vetro • metal, sticla • metalli, lasi •  
 metal, szkło • metal, cam



incl.  
 LED E14, 4 W  
 320 lm, 3.000 K

A+

989-40



↓ 20 cm, Ø 8,5 cm  
 excl. 1 x E14, max. 40 W



500011-07



↓ 21 cm, Ø 8,5 cm  
 incl. 1 x SMD, 4 W  
 320 lm, 3.000 K



574090103  
 574090106  
 574090107  
 574090128



03 Messing poliert • polished brass  
 06 chrom • chrome  
 07 Nickel matt • nickel mat  
 28 rostfarbig antik • antique rust



## Till

Nickel matt, Glas matt • nickel mat, mat glass •  
 nickel mat, verre mat • nikkell mat, mat glas •  
 níquel mate, vidrio mate • nichel opaco, vetro sabbato •  
 nichel mat, sticla mata • harjattu teräs, mattalasi •  
 nikiel mat, szkło matowane • mat nikel, mat cam



07



04



08

## Davi

Metall, Glas matt • metal, mat glass •  
 metale, verre mat • metaal, mat glas • metal, vidrio mate •  
 metallo, vetro sabbato • metal, sticla mata • metalli, mattalasi •  
 metal, szkło matowane • metal, mat cam



↓ 15 cm, ↔ 10 x 15 cm  
 excl. 1 x E14, max. 40 W

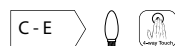

5901011-07



↓ 16 cm, ↔ 10 x 15 cm  
 excl. 1 x E14, max. 40 W

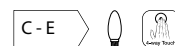

5900011-04  
 5900011-07  
 5900011-08



04 altmessing • old brass  
 07 Nickel matt • nickel mat  
 08 Messing matt • matt brass

# Zucca

chrom, Acryl • chrome, acryl •  
 chrome, acryl • chroom, acryl • cromo, acrílico •  
 cromo, acrílico • crom, acrílic • kromi, akryyli •  
 chrom, akryl • krom, akrilik

**ECO**  
 HALOGEN



92

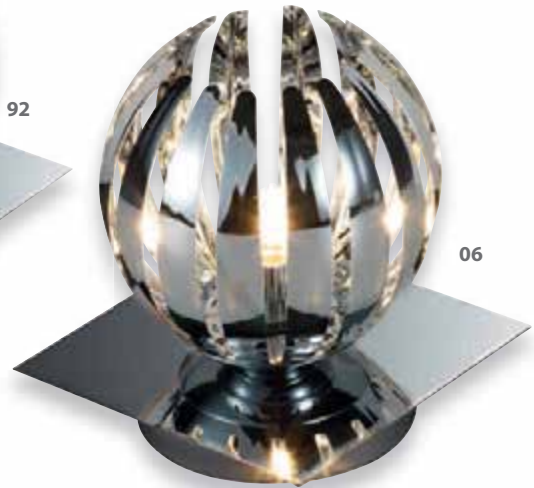

06



00



16



42



92

# Lacan

chrom, Acryl • chrome, acryl •  
 chrome, acryl • chroom, acryl • cromo, acrílico • cromo, acrílico •  
 crom, acrílic • kromi, akryyli • chrom, akryl • krom, akrilik



↓ 15 cm, ↔ 13 x 13 cm  
 incl. 1 x G9, 28 W  
 370 lm, 2.800 K



594010106  
 594010192



↓ 30 cm, Ø 13 cm  
 excl. 1 x E14, max. 40 W



593900100  
 593900116  
 593900142  
 593900192



00 transparent • transparent  
 06 chrom • chrome  
 16 gelb • yellow  
 42 anthrazit • antracite  
 92 purpurrot • purple





00



13



01

## Landino

chrom, Acryl • chrome, acryl •  
chrome, acryl • chroom, acryl • cromo, acrílico • cromo, acrílico •  
crom, acrylic • kromi, akryyli • chrom, akryl • krom, akrilik

485



↓ 23 cm, Ø 20 cm  
excl. 1 x E14, max. 40 W

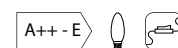

505600100  
505600101  
505600113



00 transparent • transparent  
01 weiß • white  
13 amber • amber



## Mats

Nickel matt, Stoff • nickel mat, fabric •  
 nickel mat, tissu • nikkell mat, textiel • níquel mate, tela •  
 nichel opaco, tessuto • nichel mat, textil • harjattu teräs, tekstiili •  
 nikiel mat, tkanina • mat nikel, kumaş



↑ 24 cm, Ø 14 cm  
 excl. 1 x E14, max. 40 W



599600101  
 599600102  
 599600115  
 599600119  
 599600142



**01** weiß • white  
**02** schwarz • black  
**15** grün • green  
**19** türkis • turquoise  
**42** anthrazit • anthracite



## Piet

Nickel matt, Stoff • nickel mat, fabric •  
 nickel mat, tissu • nikkel mat, textiel • níquel mate, tela •  
 nichel opaco, tessuto • nichel mat, textil • harjattu teräs, tekstiili •  
 nikiel mat, tkanina • mat nikel, kumaş



## Wim

chrom, Stoff • chrome, fabric •  
 chrome, tissu • chroom, textiel • cromo, tela • cromo, tessuto •  
 crom, textil • kromi, tekstiili • chrom, tkanina • krom, kumaş



↑ 30 cm, Ø 15,5 cm  
 excl. 1 x E14, max. 40 W



5960011-01  
 5960011-02



↑ 35,5 cm, ↔ 12 x 12 cm  
 excl. 1 x E14, max. 40 W



5914011-01  
 5914011-02  
 5914011-10  
 5914011-42



01 weiß • white  
 02 schwarz • black  
 10 rot • red  
 42 anthrazit • anthracite







## **Badezimmerleuchten**

**Bathroom lighting**  
**Éclairage salle de bains**  
**Badkamer verlichting**  
**Iluminación de cuarto de baño**  
**Illuminazione per bagno**  
**Iluminat baie**  
**Kylpyhuone valaistus**  
**Oświetlenie łazienkowe**  
**Banyo aydınlatma**

## Brandon

chrom, Acryl • chrome, acryl •  
chrome, acryl • chroom, acryl • cromo, acrílico •  
cromo, acrílico • crom, acrilic • kromi, akryyli •  
chrom, akryl • krom, akrilik



490



↑ 14,5 cm, ↔ 9 cm, ↗ 12,5 cm  
incl. 1 x SMD, 3,4 W  
260 lm, 3.000 K  
▲ IP 44

A+

282810106

↑ 22 cm, ↔ 9 cm, ↗ 12,5 cm  
incl. 2 x SMD, 3,4 W  
2 x 260 lm, 3.000 K  
▲ IP 44

A+

282810206

## Brian

chrom, Acryl • chrome, acryl •  
 chrome, acryl • chroom, acryl • cromo, acrílico •  
 cromo, acrílico • crom, acrílic • kromi, akryyli •  
 chrom, akryl • krom, akrilik

LED



491



↓ 10 cm, ↔ 8,5 cm, ∠ 12,5 cm  
 incl. 1 x SMD, 3,6 W  
 260 lm, 3.000 K  
 ▲ IP 44

↓ 16,5 cm, ↔ 8,5 cm, ∠ 12,5 cm  
 incl. 2 x SMD, 2,8 W  
 2 x 180 lm, 3.000 K  
 ▲ IP 44

A+

A+

282710106

282710206



# Bolsa

chrom, Acryl • chrome, acryl •  
 chrome, acryl • chroom, acryl • cromo, acrílico •  
 cromo, acrílico • crom, acrílic • kromi, akryyli •  
 chrom, akryl • krom, akrilik



↑ 19 cm, ↔ 7 cm, ↗ 12 cm  
 incl. 1 x SMD, 3,2 W  
 300 lm, 3.000 K  
 ▲ IP 44

A+

282410106



↑ 30 cm, ↔ 7 cm, ↗ 12 cm  
 incl. 2 x SMD, 3,2 W  
 2 x 300 lm, 3.000 K  
 ▲ IP 44

A+

282410206



Ø 41,5 cm, ↑ 16,5 cm  
 incl. 5 x SMD, 3,2 W  
 5 x 300 lm, 3.000 K  
 ▲ IP 44

A+

682410506





## Helen

chrom, Acryl • chrome, acryl •  
 chrome, acryl • chroom, acryl • cromo, acrílico •  
 cromo, acrilico • crom, acrylic • kromi, akryyli •  
 chrom, akryl • krom, akrilik



493



↔ 18 cm, ↓ 6 cm, ↗ 9,5 cm  
 incl. 1 x SMD, 4,5 W  
 430 lm, 3.000 K  
 ▲ IP 44



282510106



↔ 43 cm, ↓ 6 cm, ↗ 9,5 cm  
 incl. 2 x SMD, 4,5 W  
 2 x 430 lm, 3.000 K  
 ▲ IP 44



282510206



↔ 68 cm, ↓ 6 cm, ↗ 9,5 cm  
 incl. 3 x SMD, 4,5 W  
 3 x 430 lm, 3.000 K  
 ▲ IP 44



282510306

06

## Buttello

chrom oder Nickel matt • chrome or nickel mat •  
chrome ou nickel mat • chrom of nikkel mat • cromo o níquel mate •  
cromo o nichel opaco • crom sau nichel mat • kromi tai harjattu teräs •  
chrom lub nikiel mat • krom veyá mat nikel



494



↔ 50 cm, ↓ 5 cm, ↗ 8,5 cm  
incl. 2 x SMD, 6 W  
2 x 600 lm, 3.000 K  
▲ IP 44



281670206  
281670207



06 chrom • chrome  
07 Nickel matt • nickel mat



06

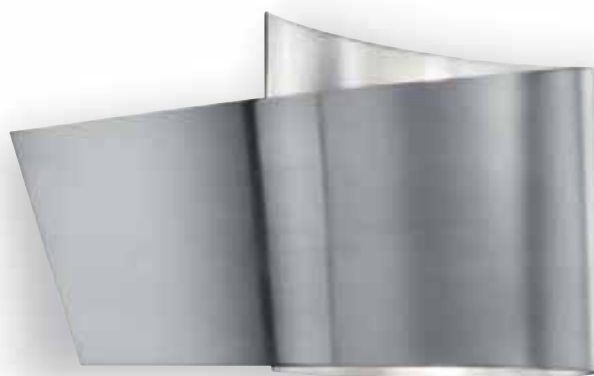

07

## Flesso

chrom oder Nickel matt • chrome or nickel mat •  
 chrome ou nickel mat • chrom of nikkel mat • cromo o níquel mate •  
 cromo o nichel opaco • crom sau nichel mat • kromi tai harjattu teräs •  
 chrom lub nikel mat • krom veya mat nikel



↔ 20 x 12 cm, ∅ 9,5 cm  
 incl. 1 x SMD, 2,3 W  
 230 lm, 3.000 K  
 ▲ IP 44

A++

282210106  
 282210107



**06** chrom • chrome  
**07** Nickel matt • nickel mat



05



01

## Compo

Aluminium gebürstet oder weiß • brushed aluminium or white • aluminium balayé ou blanc • geborsteld aluminium of wit • aluminio pulido o blanco • alluminio spazzolato o bianco • aluminiu lucios sau alb • harjattu alumiini tai valkoinen • aluminium szczotkowane lub biały • alüminyum veya beyaz

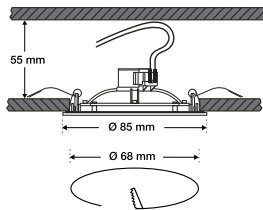

## Campino

chrom, Glas matt • chrome, mat glass • chrome, verre mat • chrom, mat glas • cromo, vidrio mate • cromo, vetro sabbiato • crom, sticla mata • kromi, mattalasi • chrom, szkło matowane • krom, mat cam



LED E14, 6 W  
470 lm, 3.000 K



A+

989-60



↑ 29,5 cm, ↔ 7 cm, ↗ 8 cm  
incl. 1 x LED E14, 6 W  
470 lm, 3.000 K  
▲ IP 44



280470106



↑ 38,5 cm, ↔ 7 cm, ↗ 8 cm  
incl. 2 x LED E14, 6 W  
2 x 470 lm, 3.000 K  
▲ IP 44

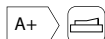

280470206



Ø 8,5 cm  
incl. 1 x SMD, 5,5 W  
380 lm, 3.000 K  
▲ IP 65



629510101  
629510105



01 weiß • white  
05 Aluminium gebürstet • brushed aluminium





## Nevio

chrom, Glas matt • chrome, mat glass •  
 chrome, verre mat • chrom, mat glas •  
 cromo, vidrio mate • cromo, vetro sabbiato •  
 crom, sticla mata • kromi, mattalasi •  
 chrom, szkło matowane • krom, mat cam



↓ 14,5 cm, ↔ 7 cm, ↗ 13 cm  
 incl. 1 x SMD, 3,2 W  
 300 lm, 3.000 K  
 ▲ IP 44

A+

282310106



↓ 21,5 cm, ↔ 7 cm, ↗ 13 cm  
 incl. 2 x SMD, 3,2 W  
 2 x 300 lm, 3.000 K  
 ▲ IP 44

A+

282310206



Ø 30 cm, ↓ 14,5 cm  
 incl. 3 x SMD, 3,2 W  
 3 x 300 lm, 3.000 K  
 ▲ IP 44

A+

682310306



## Cubo

chrom, Glas klar • chrome, clear glass •  
chrome, verre claire • chrom, helder glas • cromo, vidrio claro •  
cromo, vetro chiaro • crom, sticlă transparentă •  
kromi, kirkas lasi • chrom, przezroczyste szkło • krom, şeffaf



## Cubo

chrom, Glas klar • chrome, clear glass •  
chrome, verre claire • chrom, helder glas •  
cromo, vidrio claro • cromo, vetro chiaro •  
crom, sticlă transparentă • kromi, kirkas lasi •  
chrom, przezroczyste szkło • krom, şeffaf



## Nivel

Nickel matt, Glas matt • nickel mat, mat glass •  
nickel mat, verre mat • nikkell mat, mat glas •  
níquel mate, vidrio mate • nichel opaco, vetro sabbiato •  
nichel mat, sticla mata • harjattu teräs, mattalasi •  
nikiel mat, szkło matowane • mat nikel, mat cam



## Livello

Nickel matt, Glas matt • nickel mat, mat glass •  
nickel mat, verre mat • nikkell mat, mat glas •  
níquel mate, vidrio mate • nichel opaco, vetro sabbiato •  
nichel mat, sticla mata • harjattu teräs, mattalasi •  
nikiel mat, szkło matowane • mat nikel, mat cam



↑ 9,5 cm, ↔ 7 cm, ↗ 11 cm  
incl. 1 x SMD, 4,5 W  
400 lm, 3.000 K  
▲ IP 44

A+

281910106



↔ 25 x 25 cm, ↗ 10 cm  
incl. 4 x SMD, 4,5 W  
4 x 400 lm, 3.000 K  
▲ IP 44

A+

681910406



↑ 7 cm, ↔ 4 cm, ↗ 11 cm  
incl. 1 x SMD, 3,2 W  
300 lm, 3.000 K  
▲ IP 44

A+

281980106  
281980206 Set: 2 St./2 pc.



↔ 6 cm, ↓ 2 cm, ↗ 13,5 cm  
incl. 1 x SMD, 3,2 W  
300 lm, 3.000 K  
▲ IP 44

A+

282080106  
282080206 Set: 2 St./2 pc.

Ø 6 cm, ↓ 2 cm, ↗ 11,5 cm  
incl. 1 x SMD, 3,2 W  
300 lm, 3.000 K  
▲ IP 44

A+

282180106  
282180206 Set: 2 St./2 pc.



## Nilo

chrom, Acryl • chrome, acryl •  
 chrome, acryl • chroom, acryl • cromo, acrílico •  
 cromo, acrílico • crom, acrílic • kromi, akryyli •  
 chrom, akryl • krom, akrilik



## Darian

chrom, Glas satiniert • chrome, satinated glass •  
 chrome, verre satiné • chroom, gesatineerd glas •  
 cromo, vidrio satinado • cromo, vetro satinato •  
 crom, sticla satinata • kromi, satinoitu lasi •  
 chrom, szkło satynowe • krom, satin cam



↔ 88 x 7,5 cm, ↗ 2,5 cm  
 incl. SMD, 9 W  
 900 lm, 3.000 K  
 ▲ IP 44

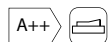

281770906



↔ 120 x 7 cm, ↗ 2,5 cm  
 incl. SMD, 12 W  
 1.200 lm, 3.000 K  
 ▲ IP 44

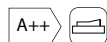

281771206



↔ 48,5 x 6 cm, ↗ 6,5 cm  
 incl. SMD, 8 W  
 500 lm, 3.500 K  
 ▲ IP 44

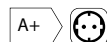

281810106



↔ 44 x 6 cm, ↗ 9 cm  
 incl. SMD, 6 W  
 600 lm, 3.000 K  
 ▲ IP 44



281570606



↔ 64 x 6 cm, ↗ 9 cm  
 incl. SMD, 9 W  
 970 lm, 3.000 K  
 ▲ IP 44



281570906





## Kolian

chrom, Acryl • chrome, acryl •  
chrome, acryl • chroom, acryl • cromo, acrílico •  
cromo, acrílico • crom, acrylic • kromi, akryyli •  
chrom, akryl • krom, akrilik





## Reflon

chrom • chrome •  
chrome • chroom • cromo • cromo •  
crom • kromi • chrom • krom



Ø 21,5 cm,  $\varnothing$  max. 45 cm  
incl. SMD, 9 W  
460 lm, 3.000 K  
▲ IP 21



282670106



## Gian

chrom, Glas matt • chrome, mat glass •  
chrome, verre mat • chroom, mat glas • cromo, vidrio mate •  
cromo, vetro sabbiato • crom, sticla mata • kromi, mattalasi •  
chrom, szkło matowane • krom, mat cam



## Sam

chrom, Glas matt • chrome, mat glass •  
chrome, verre mat • chroom, mat glas • cromo, vidrio mate •  
cromo, vetro sabbiato • crom, sticla mata • kromi, mattalasi •  
chrom, szkło matowane • krom, mat cam



## Nando

chrom, Glas matt • chrome, mat glass •  
chrome, verre mat • chroom, mat glas • cromo, vidrio mate •  
cromo, vetro sabbiato • crom, sticla mata • kromi, mattalasi •  
chrom, szkło matowane • krom, mat cam



Ø 31 cm, ↓ 12 cm  
incl. 4 x SMD, 4,5 W  
4 x 400 lm, 3.000 K  
▲ IP 44

A+

680511806



↔ 26 x 26 cm, ↓ 8,5 cm  
incl. 4 x SMD, 4,5 W  
4 x 400 lm, 3.000 K  
▲ IP 44

A+

680611206



Ø 25 cm, ↓ 11 cm  
incl. 3 x SMD, 4,5 W  
3 x 400 lm, 3.000 K  
▲ IP 44

A+

680711206



01



87

## Clarimo

weiß / Acryl oder titanfarbig / Acryl • white / acryl or titan / acryl •  
 blanc / acryl ou titane / acryl • wit / acryl of titaan / acryl •  
 blanco / acrílico o titán / acrílico • bianco / acrílico o titano / acrílico •  
 alb / acrílic sau titaniu / acrílic • valkoinen / akryyli tai titaani / akryyli •  
 biały / akryl lub tytanowy / akryl • beyaz / akrilik veya titan / akrilik



Ø 33 cm, ↑ 9 cm,  
 incl. SMD, 18 W  
 1.600 lm, 3.000 K  
 ▲ IP 44

A+



659011801  
 659011887

**01** weiß • white  
**87** titanfarbig • titanium-coloured





## Apart

Acryl • acryl •  
acryl • acryl • acrílico • acrílico •  
acrilic • akryyli • akryl • akrilik



Ø 35 cm, ↑ 9,5 cm,  
incl. SMD, 18 W  
1.600 lm, 3.000 K  
▲ IP 44



659411806



Ø 41 cm, ↑ 10 cm,  
incl. SMD, 24 W  
2.100 lm, 3.000 K  
▲ IP 44

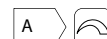

659412406



06



07



07



06

## Liria

chrom / Glas opal oder Nickel matt / Glas matt •  
 chrome / opal glass or nickel mat / mat glass •  
 chrome / verre opale ou nickel mat / verre mat • chrom / opaal glas  
 of nikkel mat / mat glas • cromo / vidrio opal o níquel mate / vidrio  
 mate • cromo / vetro opale o nichel opaco / vetro sabbbiato • crom /  
 sticla opala sau nichel mat / sticla mata • kromi / opaalilasi tai  
 harjattu teräs / mattalasi • chrom / szkło opal lub nikiel mat / szkło  
 matowane • krom / opal cam veya mat nikel / mat cam

**ECO**  
HALOGEN



## Danillo

chrom / Glas opal oder Nickel matt / Glas matt •  
 chrome / opal glass or nickel mat / mat glass •  
 chrome / verre opale ou nickel mat / verre mat • chrom / opaal glas  
 of nikkel mat / mat glas • cromo / vidrio opal o níquel mate / vidrio  
 mate • cromo / vetro opale o nichel opaco / vetro sabbbiato • crom /  
 sticla opala sau nichel mat / sticla mata • kromi / opaalilasi tai  
 harjattu teräs / mattalasi • chrom / szkło opal lub nikiel mat / szkło  
 matowane • krom / opal cam veya mat nikel / mat cam

**ECO**  
HALOGEN

## Patrice

chrom, Glas matt • chrome, mat glass •  
 chrome, verre mat • chrom, mat glas • cromo, vidrio mate •  
 cromo, vetro sabbbiato • crom, sticla mata • kromi, mattalasi •  
 chrom, szkło matowane • krom, mat cam

**ECO**  
HALOGEN



↓ 17 cm, ↔ 6 cm, ↗ 16,5 cm  
 incl. 1 x G9, 28 W  
 370 lm, 2.800 K  
 ▲ IP 21



2800011-06



↓ 25 cm, ↔ 7,2 cm, ↗ 10,5 cm  
 incl. 1 x G9, 33 W  
 458 lm, 2.800 K  
 ▲ IP 44



280870106  
 280870107



↓ 40 cm, ↔ 7,2 cm, ↗ 10,5 cm  
 incl. 2 x G9, 33 W  
 2 x 458 lm, 2.800 K  
 ▲ IP 44



280870206  
 280870207



↓ 16 cm, ↔ 5,5 cm, ↗ 7,5 cm  
 incl. 1 x G9, 28 W  
 370 lm, 2.800 K  
 ▲ IP 44



280710106  
 280710107

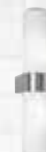

↓ 28,5 cm, ↔ 6 cm, ↗ 8 cm  
 incl. 2 x G9, 28 W  
 2 x 370 lm, 2.800 K  
 ▲ IP 44



280710206  
 280710207



06 chrom • chrome  
 07 Nickel matt • nickel mat



## Hugo

chrom, Glas matt • chrome, mat glass •  
chrome, verre mat • chrom, mat glas • cromo, vidrio mate •  
cromo, vetro sabbaiato • crom, sticla mata • kromi, mattalasi •  
chrom, szkło matowane • krom, mat cam

**ECO**  
HALOGEN

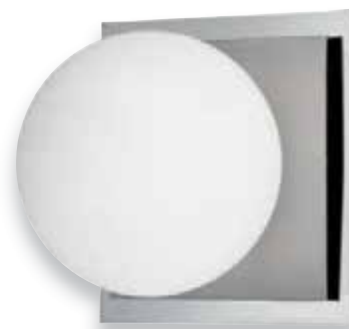

## Hamar

Nickel matt / chrom, Glas matt • nickel mat / chrome, mat glass •  
nickel mat / chrome, verre mat • nikkell mat / chrom, mat glas •  
níquel mate / cromo, vidrio mate • nichel opaco / cromo, vetro sabbaiato •  
nichel mat / crom, sticla mata • harjattu teräs / kromi, mattalasi •  
nikkiel mat / chrom, szkło matowane • mat nikel / krom, mat cam

**ECO**  
HALOGEN



## Rani

chrom, Glas matt • chrome, mat glass •  
chrome, verre mat • chrom, mat glas • cromo, vidrio mate •  
cromo, vetro sabbaiato • crom, sticla mata • kromi, mattalasi •  
chrom, szkło matowane • krom, mat cam

**ECO**  
HALOGEN



Ø 28 cm, ↓ 13 cm  
incl. 3 x G9, 28 W  
3 x 370 lm, 2.800 K  
▲ IP 21



8801331-06



↔ 12 x 12 cm, ↗ 13,5 cm  
incl. 1 x G9, 28 W  
370 lm, 2.800 K  
▲ IP 21



2802011-07



↔ 16,5 cm, ↓ 16 cm, ↗ 15 cm  
incl. 1 x G9, 28 W  
370 lm, 2.800 K  
▲ IP 21



8801211-06



↔ 37 cm, ↓ 16 cm, ↗ 15 cm  
incl. 2 x G9, 28 W  
2 x 370 lm, 2.800 K  
▲ IP 21



8801221-06



↔ 65 cm, ↓ 16 cm, ↗ 15 cm  
incl. 3 x G9, 28 W  
3 x 370 lm, 2.800 K  
▲ IP 21



8801231-06



↓ 22 cm, ↔ 16 cm, ↗ 20,8 cm  
incl. 1 x G9, 33 W  
458 lm, 2.800 K  
▲ IP 44



280610106



## Jordi

Glas matt • mat glass •  
verre mat • mat glas • vidrio mate • vetro sabbiato •  
sticla mata • mattalasi • szkło matowane • mat cam



01



07

## Condus

Metall, Glas matt • metal, mat glass •  
metale, verre mat • metaal, mat glas • metal, vidrio mate •  
metallo, vetro sabbiato • metal, sticla mata • metalli, mattalasi •  
metal, szkło matowane • metal, mat cam



Ø 26 cm, ↓ 11 cm  
excl. 1 x E27, max. 42 W  
▲ IP 44

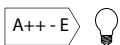

6800011-01



Ø 40 cm, ↓ 13 cm  
excl. 2 x E27, max. 42 W  
▲ IP 44

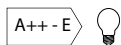

6800021-01



Ø 31,5 cm, ↓ 8 cm  
excl. 1 x E27, max. 42 W  
▲ IP 44

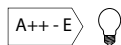

6801011-01  
6801011-06  
6801011-07



01 weiß • white  
06 chrom • chrome  
07 Nickel matt • nickel mat





## Godi

Nickel matt, Glas matt • nickel mat, mat glass •  
 nickel mat, verre mat • nikkell mat, mat glas •  
 níquel mate, vidrio mate • nichel opaco, vetro sabbaiato •  
 nichel mat, sticla mata • harjattu teräs, mattalasi •  
 nikiel mat, szkło matowane • mat nikel, mat cam



07

## Eurico

chrom oder Nickel matt, Glas matt • chrome or nickel mat, mat glass •  
 chrome ou nikkell mat, verre mat • chroom of nikkell mat, mat glas •  
 cromo o níquel mate, vidrio mate • cromo o nichel opaco, vetro sabbaiato •  
 crom sau nichel mat, sticla mata • kromi tai harjattu teräs, mattalasi •  
 chrom lub nikiel mat, szkło matowane • krom veya mat nikel, mat cam



06

## Xavi

chrom, Glas matt • chrome, mat glass •  
 chrome, verre mat • chroom, mat glas • cromo, vidrio mate •  
 cromo, vetro sabbaiato • crom, sticla mata • kromi, mattalasi •  
 chrom, szkło matowane • krom, mat cam



Ø 40 cm, ↓ 14 cm  
 excl. 5 x E14, max. 28 W  
 ▲ IP 21

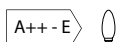

6309051-07



↔ 30,4 cm, ↑ 8 cm, ↘ 6 cm  
 excl. 2 x E14, max. 28 W  
 ▲ IP 21

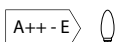

2803021-06



↔ 40,5 cm, ↑ 8 cm, ↘ 6 cm  
 excl. 3 x E14, max. 28 W  
 ▲ IP 21

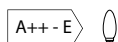

2803031-06



↔ 36 cm, ↑ 8 cm, ↘ 11 cm  
 excl. 2 x E14, max. 28 W  
 ▲ IP 21

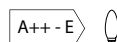

2801021-06  
 2801021-07



06 chrom • chrome  
 07 Nickel matt • nickel mat





# Leuchtmittel

Light sources  
Ampoules  
Lichtbronnen  
Fuentes de luz  
Lampadine  
Becuri  
Valonlähteet  
Źródła światła  
Işık kaynakları

# LED-Filament-Leuchtmittel

LED-filament bulbs • Lampes LED-filament • LED-gloeilampen • Lámparas de filamento de LED • Lampade a filamento LED • Lämpö cu LED-filament • LED-hehkulamput • Lampy LED-żarowe • LED-filamanlı lambalar



extern dimbar • externally dimmable • dimmable externe • extern dimbaar • regulador externo • dimmer esterno • variator extern de lumina • himmennettävissä • zewnętrznie ściemniania • untranslated



Switch Dimmer • dimmable via switch • réglable par interrupteur • dimbaar via schakelaar • regulable mediante interruptor • dimmerabile tramite interruttore • estompat prin comutator • himmennettävä kytkimen • ściemniałne za pośrednictwem przełącznika • anahtarı üzerinden kısılabilir



↓ 115 mm, ↔ 60 mm  
Filament LED E27, 4 W  
400 lm, 3.000 K  
10.000 h

A++

**987-400**  
**987-2400** Blister: 2 St./2 pc.



**dimmable**

↓ 105 mm, ↔ 60 mm  
Filament LED E27, 6 W  
600 lm, 3.000 K  
10.000 h

A+

**987-660**



↓ 135 mm, ↔ 95 mm  
Filament LED E27, 6 W  
600 lm, 3.000 K  
10.000 h

A+

**988-600**



**dimmable**

↓ 135 mm, ↔ 95 mm  
Filament LED E27, 6 W  
600 lm, 3.000 K  
10.000 h

A+

**988-660**



↓ 135 mm, ↔ 95 mm  
Filament LED E27, 6 W  
420 lm, 2.700 K  
10.000 h

A+

**988-679**







↓ 140 mm, ↔ 64 mm  
Filament LED E27, 6 W  
600 lm, 3.000 K  
10.000 h

A+

**987-600**



↓ 140 mm, ↔ 64 mm  
Filament LED E27, 6 W  
420 lm, 2.700 K  
10.000 h

A+

**987-679**



↓ 99 mm, ↔ 35 mm  
Filament LED E14, 4 W  
400 lm, 3.000 K  
10.000 h

A++

**989-400**



↓ 99 mm, ↔ 35 mm  
Filament LED E14, 4 W  
280 lm, 2.700 K  
10.000 h

A+

**989-479**



↓ 120 mm, ↔ 35 mm  
Filament LED E14, 4 W  
400 lm, 3.000 K  
10.000 h

A++

**990-400**



↓ 78 mm, ↔ 45 mm  
Filament LED E14, 4 W  
470 lm, 3.000 K  
10.000 h

A++

**983-400**



**Display**  
VE/moq: 10 St./10 pc.



# LED-Leuchtmittel

LED bulbs • Ampoules LED • LED-lampen • Bombillas a LED • Lampadine a LED •  
Becuri cu LED-uri • LED-Valonlähdeet • Żarówki LED • LED ampuller



extern dimmbar • externally dimmable • dimmable externe • extern dimbaar • regulador externo • dimmer esterno •  
variator extern de lumina • himmennettävissä • zewnętrznie ściemniania • untranslated



Switch Dimmer • dimmable via switch • réglable par interrupteur • dimbaar via schakelaar • regulable mediante interruptor • dimmerabile tramite interruttore •  
estompat prin comutator • himmennettävä kytkimen • ściemniałne za pośrednictwem przełącznika • anahtari üzerinden kısılabilir



↓ 103 mm, ↔ 60 mm  
LED E27, 5 W  
400 lm, 3.000 K  
25.000 h

A+

**988-50**  
**988-250** Blister: 2 St./2 pc.



↓ 106 mm, ↔ 60 mm  
LED E27, 6 W  
470 lm, 3.000 K  
25.000 h

A+

**987-60**



↓ 108 mm, ↔ 60 mm  
LED E27, 6 W  
470 lm, 3.000 K  
25.000 h



**dimmable**

**988-60**



↓ 118 mm, ↔ 60 mm  
LED E27, 10 W  
806 lm, 3.000 K  
25.000 h

A+

**988-100**



↓ 110 mm, ↔ 60 mm  
LED E27, 10 W  
806 lm, 3.000 K  
25.000 h



**switchDimmer**

**988-10**



↓ 151 mm, ↔ 90 mm  
LED E27, 10 W  
806 lm, 3.000 K  
25.000 h

A+

**dimmable**

**987-10**



↓ 128 mm, ↔ 90 mm  
LED E27, 4 W  
310 lm, 3.000 K  
25.000 h

A+

**987-40**





↓ 75 mm, ↔ 45 mm  
LED E27, 4 W  
320 lm, 3.000 K  
25.000 h



**986-40**  
**986-43** Blister: 3 St./3 pc.



↓ 80 mm, ↔ 45 mm  
LED E27, 6 W  
470 lm, 3.000 K  
25.000 h



**986-60**  
**986-63** Blister: 3 St./3 pc.



↓ 99 mm, ↔ 37 mm  
LED E14, 4 W  
320 lm, 3.000 K  
25.000 h



**989-40**  
**989-43** Blister: 3 St./3 pc.



↓ 99 mm, ↔ 37 mm  
LED E14, 6 W  
470 lm, 3.000 K  
25.000 h



**989-60**  
**989-63** Blister: 3 St./3 pc.



**switchDimmer**

↓ 99 mm, ↔ 37 mm  
LED E14, 6 W  
470 lm, 3.000 K  
25.000 h



**989-66**



↓ 130 mm, ↔ 37 mm  
LED E14, 4 W  
320 lm, 3.000 K  
25.000 h



**990-40**



↓ 80 mm, ↔ 45 mm  
LED E14, 4 W  
320 lm, 3.000 K  
25.000 h



**983-40**  
**983-43** Blister: 3 St./3 pc.



↓ 80 mm, ↔ 45 mm  
LED E14, 6 W  
470 lm, 3.000 K  
25.000 h



**983-60**  
**983-63** Blister: 3 St./3 pc.



**switchDimmer**

↓ 80 mm, ↔ 45 mm  
LED E14, 4 W  
470 lm, 3.000 K  
25.000 h



**983-66**



↓ 80 mm, ↔ 45 mm  
LED E27, 4 W  
25.000 h

**986-10** rot • red  
**986-12** blau • blue  
**986-15** grün • green



↓ 80 mm, ↔ 45 mm  
LED E14, 4 W  
25.000 h

**983-10** rot • red  
**983-12** blau • blue  
**983-15** grün • green



**Display**  
VE/moq: 10 St./10 pc.

# LED-Leuchtmittel

LED bulbs • Ampoules LED • LED-lampen • Bombillas a LED • Lampadine a LED •  
Becuri cu LED-uri • LED-Valonlähteet • Żarówki LED • LED ampuller



extern dimmbar • externally dimmable • dimmable externe • extern dimbaar • regulador externo • dimmer esterno •  
variator extern de lumina • himmennettävissä • zewnętrznie ściemniania • untranslated



Switch Dimmer • dimmable via switch • réglable par interrupteur • dimbaar via schakelaar • regulable mediante interruptor • dimmerabile tramite interruttore •  
estompat prin comutator • himmennettävä kytkimen • ściemniałne za pośrednictwem przełącznika • anahtarı üzerinden kısılabilir



↓ 80 mm, ↔ 50 mm  
LED E14, 5 W  
400 lm, 3.000 K  
25.000 h

A+

**955-55**



↓ 58 mm, ↔ 50 mm  
LED GU10, 2,5 W  
170 lm, 3.000 K  
25.000 h

A++

**956-236** Blister: 2 St./2 pc.



↓ 53 mm, ↔ 50 mm  
LED GU10, 3 W  
230 lm, 3.000 K  
25.000 h

A+

**956-30**  
**956-230** Blister: 2 St./2 pc.



↓ 60 mm, ↔ 50 mm  
LED GU10, 5 W  
400 lm, 3.000 K  
25.000 h

A+

**955-50**  
**955-250** Blister: 2 St./2 pc.



↓ 53 mm, ↔ 50 mm  
LED GU10, 5 W  
400 lm, 3.000 K  
25.000 h

A+

**956-53** Blister: 3 St./3 pc.

516



**switchDimmer**

↓ 53 mm, ↔ 50 mm  
LED GU10, 5 W  
400 lm, 3.000 K  
25.000 h

A+



**956-55**



**dimmable**

↓ 58 mm, ↔ 50 mm  
LED GU10, 6 W  
400 lm, 3.000 K  
25.000 h

A+



**955-60**



↓ 48 mm, ↔ 16 mm  
LED G9, 2 W  
180 lm, 3.000 K  
15.000 h

A++

**929-220** Blister: 2 St./2 pc.



**dimmable**

↓ 55 mm, ↔ 18 mm  
LED G9, 3,5 W  
300 lm, 3.000 K  
25.000 h

A+



**929-235** Blister: 2 St./2 pc.



↓ 55 mm, ↔ 18 mm  
LED G9, 2 W  
170 lm, 3.000 K  
20.000 h

A++

**929-25** Blister: 2 St./2 pc.



# Halogen-Leuchtmittel

Halogen bulbs • Ampoules halogènes • Halogeenlampen • Bombillas halógenas •  
Lampade alogene • Lāmpi cu halogen • Halogeenilamput • Żarówki halogenowe • Halojen lambalar



↓ 41 mm, ↔ 13 mm  
G9, 18 W  
204 lm, 2.800 K  
2.000 h



**919-18** Blister: 3 St./3 pc.



↓ 41 mm, ↔ 13 mm  
G9, 28 W  
370 lm, 2.800 K  
2.000 h



**919-28** Blister: 3 St./3 pc.



↓ 41 mm, ↔ 13 mm  
G9, 33 W  
458 lm, 2.800 K  
2.000 h



**919-33** Blister: 3 St./3 pc.



↓ 118 mm, ↔ 10 mm  
R7S, 230 W  
4.650 lm, 2.800 K  
2.000 h



**945-23**

**930-23** Blister: 3 St./3 pc.



↓ 30 mm, ↔ 8 mm  
G4, 20 W  
260 lm, 2.800 K  
2.000 h



**930-20**



↓ 57 mm, ↔ 50 mm  
GU10, 35 W  
240 lm, 2.800 K  
2.000 h



**910-35**



↓ 57 mm, ↔ 50 mm  
GU10, 50 W  
310 lm, 2.800 K  
2.000 h



**967-53** Blister: 3 St./3 pc.



↓ 57 mm, ↔ 50 mm  
GU10, 50 W  
310 lm, 2.800 K  
2.000 h



**967-50** Pack: 5 St./5 pc.

# Halogen-Leuchtmittel

Halogen bulbs • Ampoules halogènes • Halogeenlampen • Bombillas halógenas •  
Lampade alogene • Lāmpi cu halogen • Halogeenilamput • Żarówki halogenowe • Halojen lambalar



↓ 102 mm, ↔ 60 mm  
E27, 28 W  
370 lm, 2.800 K  
2.000 h



**966-28** Pack: 3 St./3 pc.



↓ 102 mm, ↔ 60 mm  
E27, 42 W  
625 lm, 2.800 K  
2.000 h



**966-42** Pack: 3 St./3 pc.



↓ 135 mm, ↔ 95 mm  
E27, 52 W  
825 lm, 2.800 K  
2.000 h



**965-52**



↓ 98 mm, ↔ 35 mm  
E14, 18 W  
204 lm, 2.800 K  
2.000 h



**960-18** Pack: 3 St./3 pc.



↓ 98 mm, ↔ 35 mm  
E14, 28 W  
370 lm, 2.800 K  
2.000 h



**960-28** Pack: 3 St./3 pc.



↓ 125 mm, ↔ 35 mm  
E14, 28 W  
370 lm, 2.800 K  
2.000 h



**962-28** Pack: 3 St./3 pc.



↓ 77 mm, ↔ 45 mm  
E14, 18 W  
204 lm, 2.800 K  
2.000 h

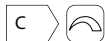

**964-18** Pack: 3 St./3 pc.



↓ 77 mm, ↔ 45 mm  
E14, 28 W  
370 lm, 2.800 K  
2.000 h



**964-28** Pack: 3 St./3 pc.



↓ 85 mm, ↔ 51 mm  
E14/R50, 40 W  
380 lm, 2.800 K  
2.000 h

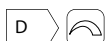

**973-40** Pack: 5 St./5 pc.



# Displays

Présentoirs • Espositores • Espositori •  
Display-uri • Telineet • Wyświetla • Teşhir



519

↔ 80 x 78 cm, † 160 cm

**9950 RK50**

# Displays

Présentoirs • Espositores • Espositori •  
Display-uri • Telineet • Wyświetla • Teşhir



520

↔ 120 x 80 cm, ↑ 235 cm

**RK10**



# Displays

Présentoirs • Espositores • Espositori  
• Display-uri • Telineet • Wyświetla • Teşhir



521

↔ 80 x 80 cm, † 215 cm

**7700 RK38**

# Displays

Présentoirs • Espositores • Espositori •  
Display-uri • Telineet • Wyświetla • Teşhir



522

↔ 118 x 78 cm, ↑ 160 cm

**6570 RK43**

# Displays

Présentoirs • Espositores • Espositori  
• Display-uri • Telineet • Wyświetla • Teşhir



523

↔ 118 x 70 cm, ↓ 160 cm

**2730 RK34**

# Displays

Présentoirs • Espositores • Espositori •  
Display-uri • Telineet • Wyświetla • Teşhir



524

↔ 120 x 80 cm, † 225 cm

**5803 RK13**



# Displays

Présentoirs • Espositores • Espositori  
• Display-uri • Telineet • Wyświetla • Teşhir



525

↔ 120 x 80 cm, ↓ 235 cm

**3045 RK39**

# Displays

Présentoirs • Espositores • Espositori •  
Display-uri • Telineet • Wyświetla • Teşhir



526

↔ 120 x 80 cm, † 140 cm

**RK02**

# Displays

Présentoirs • Espositores • Espositori  
• Display-uri • Telineet • Wyświetla • Teşhir



↔ 120 x 80 cm, ↑ 140 cm

**RK01**



↔ 40 x 35 cm, ↑ 160 cm

**25000 P01**







# Licht für Haus und Garten

Light for house and garden • Lumière pour la maison et le jardin • Verlichting voor huis en tuin •  
Luz para la casa y el jardín • Luce per la casa e giardino • Iluminat pentru casa si gradina •  
Valoa kotiin ja puutarhaan • Światło dla domu i ogrodu • Ev ve Bahçe için Aydınlatma

In unserem aktuellen Outdoor-Katalog 2016/2017 finden Sie ein umfangreiches Sortiment an hocheffizienten Außenleuchten mit modernster LED-Technik.

In our current outdoor catalog 2016/2017 you will find an extensive range of highly efficient outdoor luminaires including latest LED technology.

Dans notre catalogue extérieure actuelle 2016/2017, vous trouverez une vaste gamme de luminaires d'extérieur très efficaces, y compris la plus récente technologie LED.

In onze huidige outdoor catalogus 2016/2017 vindt u een uitgebreid gamma van zeer efficiënte buitenverlichtings armaturen met de nieuwste LED-technologie.

Luz para la casa y el jardín En nuestro actual catálogo 2016/2017 exterior se encuentra una amplia gama de alta eficiencia de iluminación al aire libre con la última tecnología LED.

Iluminazione per la casa e il giardino. Nel nostro catalogo 2016/2017 potrete trovare un vasto assortimento prodotti outdoor ad alta efficienza luminosa di ultima tecnologia LED.

In catalogul nostru actual 2016/2017 veti gasi o colectie extinsa de corpuri de iluminat pentru exterior, foarte eficiente, incluzand ultima tehnologie LED.

Nykyisestä 2016/2017 ulkovalaisin kuvastosta löydät laajan valikoiman tehokkaita LED teknologiaa sisältäviä valaisimia.

W naszym aktualnym zewnętrznym Katalogu 2016/2017 znajdzie Państwo szeroką gamę wysokiej sprawności zewnętrznego oświetlenia z najnowszą technologii LED.

2016/2017 dış mekan kataloğumuzda, en gelişmiş LED teknolojisini kullanan ve son derece tutumlu dış mekan ürünlerini bulabilirsiniz.

[www.trio-leuchten.de](http://www.trio-leuchten.de)

[www.trio-lighting.com](http://www.trio-lighting.com)





# Spezifikationen

Specifications  
Spécifications  
Specifikaties  
Especificaciones  
Specifiche  
Specificații  
Tekniset tiedot  
Specyfikacje  
Özellikler

# Produkteigenschaften

Features • Caractéristiques • Kenmerken • Acabados •  
Caratteristiche • Caracteristici • Ominaisuudet • Cechy • Özellikleri



## Schalter • switch

interrupteur • schakelaar • interruptor • interruttore • intrerupator • kytkin • przełącznik • anahtar



## Fußschalter • footswitch

interrupteur à pédale • voetschakelaar • interruptor de pie • interruttore a pedale • comutator picior •  
päälle / pois jalkakytin • wyłącznik nożny • ayak anahtarı



## Schnurschalter • cable switch

interrupteur de cordon • snoerschakelaar • cable de interruptor • interruttore su cavo • intrerupator cu cablu •  
katkaisin ja johto • przełącznik na kablu • kablo anahtar



## Zugschalter • pull switch

interrupteur de trait • trekschakelaar • interruptor de tiro • interruttore con tirata • interupator de tragere •  
vetokytkin • przełącznik pociągany • çekemelianahatar



## getrennt schaltbar • separately switchable

interrupteurs séparés gescheiden schakelbaar • interruptores separados • interruttori separati •  
intrerupatoare separate • erikseen kytkettävissä • oddzileny przełącznik • dışarıdan anahtarlı



## On/Off Touch Funktion • on/off touch function

interrupteur tactile on/off • touch schakelaar on/off • función táctil on/off • interruttore touch on/off •  
intrerupator tactil on/off • kosketuskäyttöinen on/off • funkcja dotykowa on/off • temas kontrolü on/off



## 4-fach TOUCH • 4 level touch function

interrupteur tactile 4 niveaux • touch schakelaar 4 niveaus • función táctil 4 nivel • interruttore touch 4 livelli •  
intrerupator tactil 4 nivele • kosketuskäyttöinen 4 taso • funkcja dotykowa 4 poziomy • temas kontrolü 4 düzeyleri



## Dimmer • dimmer

variateur • dimmer • regulador • dimmer • variator • himmennin • ściemniacz • dimer



## extern dimmbar • externally dimmable

dimnable externe • extern dimbaar • regulador externo • dimmer esterno • variator extern de lumina •  
himmennettävissä • zewnętrznie ściemniana • untranslated



## Fernbedienung • remote control

commande à distance • afstandsbediening • mando a distancia • comando a distanza • telecomanda • kauko-ohjain • pilot • uzaktan kumanda



## Sensordimmer • sensor dimmer

variateur tactile • touchdimmer • regulador con sensor • touchdimmer • variator cu senzor • kosketushimmennin •  
czujnik ściemniania • el dimeri



## Switch dimmer • dimmable via switch

réglable par interrupteur • dimbaar via schakelaar • regulable mediante interruptor • dimmerabile tramite interruttore • estompat prin comutator •  
himmennettävä kytkimen • ściemniálne za pośrednictwem przełącznika • anahtarı üzerinden kısılabilir



## AUTO - Dimmer • auto - dimmer

variateur auto • auto dimmer • regulador automatico • auto dimmer • auto variator • himmennin auto • ściemniacz auto • auto dimer



## RGB Farbwechsler • rgb colorchanging

changement de couleur rgb • rgb kleurverandering • cambio de color rgb • cambia colore rgb •  
schimbator de culoare rgb • värvivaihto rgb • zmieniający kolor rgb • renk deęiřtiren rgb





Lichtfarbe einstellbar • adjustable light color

couleur de lumière réglable • lichttemperatuur instelbaar • color de luz regulable • colore della luce regolabile • lumina colorata reglabila • värilämpötila säädettävissä • regulowana barwa światła • ayarlanabilir ışık rengi



Lichtfarbe stufenlos einstellbar • light color infinitely variable

couleur de lumière infiniment variable • lichtkleur traploos instelbaar • color de luz infinitamente variable • colore della luce infinitamente variabile • culoare lumină infinit variabilă • valon väri portaattomasti • jasny kolor bezstopniowo • açık renk sonsuz değişken



Nachtlicht • night light

veuilleuse de nuit • nachtlicht • luz de la noche • luce notturna • lampä de noapte • yyövalo • lampka nocna • gece lambası



höhenverstellbar • adjustable height

hauteur réglable • in hoogte verstelbaar • altura regulable • altezza regolabile • inaltime reglabila • säädettävä korkeus • regulowana wysokość • ayarlanabilir yükseklik



schwenkbar • tiltable

pivotant • draaibaar • pivotante • girevole • pivotant • suunnattava • skrętny • eğilebilir



flexibel • flexible

flexible • flexibel • flexible • flessibile • flexibel • joustava • elastyczne • esnek



Steckdose • plug

prise • stekker • enchufe • spina • priza • katkaisin • gniazdko • priz



Vergrößerung 3x • magnification 3x

magnification 3x • vergroting 3x • aumentos 3x • ingrandimento 3x • suplimentare 3x • suurentava 3x • powiększenie 3x • büyütme 3x



USB Anschluss • usb connection

entrée usb • aansluiting • conexión usb • connessione usb • conexiune usb • usb-liitäntä • połączenie usb • usb bağlantısı



USB Anschluss mit Ladefunktion • recharging usb connection

entrée usb de rechargement • opladende usb aansluiting • conexión usb de recarga • connessione usb di ricarica • conexiune usb reîncărcare • lataaminen usb-liitäntä • ładowania usb połączenie • şarj usb bağlantısı



induktive Ladestation • inductive loading station

station de chargement inductif • inductief laadstation • estación de carga inductiva • stazione di carico induttivo • stație de încărcare inductivă • induktiivinen latausasema • stacja ładowania indukcyjnego • endüktif yükleme istasyonu



Licht nach oben und unten • up and down lighting

point lumineux en haut et en bas • lichtpunt boven en onder • luz de arriba y abajo • luce su e giù • sus și în jos lumina • ylös ja alas valoa • w górę iw dół światło • yukarı ve aşağı ışık



Sleep-Timer • sleep timer

compte-minutes de sommeil • sleeptimer • temporizador de sueño • timer di spegnimento • sleep timer • uniajastin • wyłącznik czasowy • uyku zamanlayıcısı



Weckfunktion • wake up function

fonction réveil • wekfunctie • despierte • sveglia • trezeste-te funcția • herätys toiminto • obudź się funkcji • işlevini uyan

# Farben & Materialien

Colours and materials • Couleurs et matériaux • Kleuren en materialen • Colores y materiales • Colori e materiali • Culori si materiale • Värit ja materiaalit • Kolory i materiały • Renkler ve malzemeler

- 00** transparent • transparent  
transparent • transparant • transparente • transparente • transparent • kirkas • przezroczysty • şeffaf
- 01** weiß • white  
blanc • wit • blanco • bianco • alb • valkoinen • biały • beyaz
- 02** schwarz • black  
noir • zwart • negro • nero • negru • musta • czarny • siyah
- 03** Messing poliert • polished brass  
laiton polis • gepolijst messing • bronze • ottone lucido • bronz • messinki • mosiądz polerowany • piring
- 04** altmessing • old brass  
laiton fumé • oud brons • bronze vieja • ottone invecchiato • bronz antic • antiikkimessinki • patyna • antik piring
- 05** Aluminium gebürstet • brushed aluminium  
aluminium balayé • geborsteld aluminium • aluminio pulido • alluminio spazzolato • aluminiu lucios • harjattu alumiini • aluminium szczotkowane • alüminyum
- 06** chrom • chrome  
chrome • chroom • cromo • cromo • crom • kromi • chrom • krom
- 07** Nickel matt • nickel mat  
nickel mat • nikkel mat • niqel mate • nichel opaco • nichel mat • harjattu teräs • nikiel mat • mat nikel
- 08** Messing matt • brass mat  
laiton mat • messing mat • bronze mate • ottone satinato • bronz mat • mattamessinki • mosiądz mat • mat piring
- 09** aluminiumfarbig • aluminium colour  
couleur aluminium • aluminium kleurig • aluminio pintado • alluminio • aluminiu colorat • alumiini • aluminium malowane • alüminyum
- 10** rot • red  
rouge • rood • rojo • rosso • rosu • punainen • czerwony • kırmızı
- 11** grau • grey  
gris • grijs • gris • grigio • gri • harmaa • popielaty • gri
- 12** blau • blue  
bleu • blauw • azul • azzurro • gri • sininen • niebieski • mavi
- 13** amber • amber  
ambre • amber • ámbar • ambră • amber • meripihka • bursztynowy • amber
- 14** alabasterfarbig • alabaster  
albâtre • alabaster • alabastro • alabastro • albastru • alabasteri • alabastrowy • alabaster
- 15** grün • green  
vert • groen • verde • verde • verde • vihreä • zielony • yeşil
- 16** gelb • yellow  
jaune • geel • amarillo • giallo • galben • keltainen • żółty • sarı
- 17** mehrfarbig • multicolor  
multicolore • multicolor • multicolor • multicolore • multicolor • monivärinen • multi-kolor • çok renkli
- 18** orange • orange  
orange • oranje • naranja • arancione • portocaliu • oranssi • pomarańczowy • turuncu
- 19** türkis • turquoise  
turquoise • turquoise • turquesa • turchese • turcoaz • turkoosi • turkusowy • turkuvaz
- 27** weiß antik • antique white  
blanc antique • antiek wit • blanco decapé • bianco anticato • alb antic • antiikkivalkoinen • antyczny biały • antik beyaz
- 28** rostfarbig antik • antique rust  
rouille antique • roestkleur antiek • oxido • ruggine anticato • ruginiu antic • rustiikki • antyczny rdzawy • antik pas rengi
- 29** kupfer matt • copper mat  
cuivre mat • koper mat • estera de cobre • rame opaco • cupru mat • kupari mat • miedź mat • bakır mat
- 31** weiß matt • white mat  
blanc mat • wit mat • estera blanca • bianco opaco • alb mat • valkoinen matto • biały mat • beyaz mat
- 32** schwarz matt • black mat  
noir mat • mat zwart • estera negra • nero opaco • negru mat • musta matto • czarny mat • siyah mat
- 42** anthrazit • anthracite  
antracite • antraciet • antracita • antracite • antracit • antrasiitti • antracyt • antrasit
- 51** apfelgrün • applegreen  
vert pomme • appelgroen • verde manzana • verde mela • verde mar • omenanvihreä • zielone jabłko • elma yeşili
- 60** kupferfarbig • copper  
cuivré • koperkleurig • color cobre • colore rame • cupru • kuperinvärinen • kolorze miedzi • bakır renkli
- 61** grau antik • antique grey  
gris ancien • antiek grijs • gris antiguo • grigio antico • antic gri • antiikki harmaa • starodawny szary • antika gri
- 62** kupfer antik • antique copper  
cuivre ancien • antiek koper • cobre antiguo • rame antico • cupru antic • antiikki kupari • antyczne miedzi • antik bakır
- 78** betonfarbig • concrete look  
couleur beton • beton kleur • color concreto • calcestruzzo • culoare beton • konkreettisia väri • konkretny kolor • beton rengi
- 79** goldfarbig • gold  
or • goud • oro • oro • aur • kultaa • złota • altın
- 87** titanfarbig • titan  
titane • titaan • titán • titano • titaniu • titaani • tytanowy • titan
- 88** silber antik • antique silver  
argent antique • antiek zilver • plateado antiguo • argento anticato • argint antic • antiikkihopea • antyczne srebro • gümüş antika
- 89** silberfarbig • silver  
argent • zilver • plata • argento • argint • hopea • srebrny • gümüş
- 91** lila • lilac  
lilla • lilla • lila • lilla • lila • lila • liliowy • leylak
- 92** purpurrot • purple  
pourpre • paars • púrpura • porpora • purpurium • purppura • purpurowy • mor

# Garantiebestimmungen

Guarantee • Garantie • Garantie • Garantia •  
Garanzia • Garantie • Takuu • Gwarancja • Garanti

Als innovatives und zukunftsorientiertes Unternehmen legen wir großen Wert auf die Qualität und Zuverlässigkeit unserer Produkte. Alle unsere Sortimentsartikel unterliegen der TRIO-Qualitätskontrolle. Sollte dennoch ein TRIO-Produkt aufgrund von Material- oder Fabrikationsfehlern Defekte aufweisen, gewähren wir zur gesetzlichen Gewährleistung eine Garantie auf alle Sortimentsartikel nach Maßgabe der nachfolgenden Bestimmungen. Die gesetzlichen Rechte insbesondere im Hinblick auf Gewährleistung und Konsumentenschutz werden hierdurch keinesfalls eingeschränkt.

1. Die Garantiezeit beträgt 24 Monate und beginnt am Tag des Produktkaufs bei einem autorisierten Händler.
2. Die Garantiebestimmungen gelten ausschließlich für ordnungsgemäß installierte und betriebene Produkte, die unter den in der Produktbeschreibung genannten Anwendungsbedingungen eingesetzt werden.
3. Während der Garantiezeit werden Produkte, die aufgrund von technischen Defekten ausfallen, nach unserem Ermessen kostenlos repariert oder ersetzt.
4. Die Garantieleistungen bewirken weder eine Verlängerung der Garantiezeit, noch setzen sie eine neue Garantie in Gang.
5. Garantieansprüche müssen unverzüglich nach Kenntniserlangung vom Defekt innerhalb der Garantiezeit geltend gemacht werden.

## TRIO LED-Garantie

Einer der Vorteile von LEDs ist ihre extrem lange Lebensdauer. Aus diesem Grund statten wir unsere LED-Leuchten mit ausgewählten Komponenten aus, um den hohen Qualitätsansprüchen gerecht zu werden. So setzen wir in unseren LED-Leuchten auch Qualitäts-LEDs der Marke Osram ein, und erzielen dadurch ein Höchstmaß an Effizienz und Zuverlässigkeit.

Da wir von unserer LED-Qualität überzeugt sind, gewähren wir auf alle Leuchten mit fest verbauten LEDs, eine Garantiezeit von 3 Jahren. Wir wünschen Ihnen viel Freude an unseren Produkten.

As an innovative and future-oriented company, we place great importance on the quality and reliability of our products. All our products are subject to TRIO's quality assurance. Should a TRIO product nevertheless have a defect in material or workmanship, we give a guarantee for all products in accordance with the following provisions and in addition to the statutory warranty. This does not restrict your statutory rights especially in terms of warranty and consumer protection.

1. The guarantee period is 24 months and starts on the day when the product was purchased from an authorised dealer.
2. The guarantee provisions apply exclusively for properly installed and operated products that are used under application conditions specified in the product description.
3. Products that fail due to technical defects will be repaired or replaced free of charge at our discretion during the guarantee period.
4. The guarantee service does not extend the guarantee period nor does it start a new guarantee period.
5. Guarantee claims must be asserted immediately upon becoming aware of the defect within the guarantee period.

## TRIO LED Guarantee

As one of the advantages of LED's is their extremely long service life, we equip LED lights with selected components in order to meet high quality standards. We use, for example, high-quality Osram LED's for our LED lights and thus achieve maximum efficiency and reliability.

As we are convinced of our LED quality, we give a guarantee of 3 years for all lights with non-replaceable LED's.

We wish you much enjoyment with our products.

En tant qu'entreprise innovante et tournée vers le futur, nous accordons une grande importance à la qualité et à la fiabilité de nos produits. Tous nos articles sont soumis à un contrôle qualité TRIO. Si un produit TRIO présentait cependant un défaut en raison d'une fabrication ou d'un matériau défectueux, nous assurons, pour garantie légale, une couverture pour tous les articles conformément aux dispositions suivantes. Ce faisant, les droits légaux, en particulier au regard de la garantie et de la protection du consommateur, ne seront en aucun cas restreints.

1. La durée de la garantie est de 24 mois et commence le jour de l'achat auprès d'un commerçant agréé.
2. Les dispositions de garantie sont exclusivement valables pour les produits installés et manipulés correctement et dans le respect des conditions d'utilisation présentées dans la description du produit.
3. Pendant la durée de la garantie, les produits en panne en raison d'un défaut technique seront réparés ou remplacés gratuitement, selon notre appréciation.
4. Les services de garantie n'ont pas pour effet de prolonger la durée de garantie, ni de la renouveler.
5. Il faut faire valoir les droits de garantie immédiatement après la découverte du défaut et au cours de la période de garantie.

## Garantie LED TRIO

Dans la mesure où l'un des avantages des LED est leur très longue durée de vie, nous équipons nos lampes à LED avec des composants sélectionnés afin de répondre aux plus hautes exigences en matière de qualité. C'est pourquoi nous utilisons également des LED de qualité de la marque Osram dans nos lampes, ce qui nous permet d'atteindre une efficacité et une fiabilité inégalées.

Dans la mesure où nous sommes convaincus de la qualité de nos LED, nous garantissons toutes nos lampes équipées de LED fixes pendant 3 ans.

Nous espérons que nos produits vous satisferont pleinement.

# Garantiebestimmungen

Guarantee • Garantie • Garantie • Garantia •  
Garanzia • Garantie • Takuu • Gwarancja • Garanti

Als innovatieve en toekomstgerichte onderneming hechten wij veel belang aan de kwaliteit en betrouwbaarheid van onze producten. Alle artikelen in ons assortiment worden onderworpen aan de TRIO-kwaliteitscontrole. Indien een TRIO-product toch defecten zou vertonen op grond van materiaal- of productiefouten, verlenen wij voor de wettelijke waarborg een garantie op alle artikelen in het assortiment in overeenstemming met de onderstaande bepalingen. De wettelijke rechten in het bijzonder met het oog op de waarborg en consumentenbescherming worden hierdoor in geen geval beperkt.

1. De garantieperiode bedraagt 24 maanden en begint op de datum van de aankoop van het product bij een geautoriseerde handelaar.
2. De garantiebepalingen gelden uitsluitend voor reglementair geïnstalleerde en gebruikte producten, die ingezet worden onder de in de productbeschrijving genoemde toepassingsvoorwaarden.
3. Tijdens de garantieperiode worden producten, die op grond van technische defecten uitvallen, volgens onze beoordeling gratis hersteld of vervangen.
4. De garantieprestaties leiden niet tot een verlenging van de garantieperiode, noch geven ze recht op een nieuwe garantie.
5. Garantieclaims moeten onverwijld na de vaststelling van het defect binnen de garantieperiode ingediend worden.

## TRIO led-garantie

Gezien één van de voordelen van leds hun extreem lange levensduur is, voorzien wij onze ledlampen van geselecteerde componenten om te beantwoorden aan de hoge kwaliteitseisen. Zo gebruiken wij in onze ledlampen ook kwaliteitsvolle leds van het merk Osram en verkrijgen daardoor een maximale efficiëntie en betrouwbaarheid.

Gezien wij overtuigd zijn van onze led-kwaliteit, verlenen wij op alle lampen met vast ingebouwde leds, een garantieperiode van 3 jaren. Wij wensen u veel plezier met onze producten.

Como empresa innovadora y orientada al futuro, damos un gran valor a la calidad y a la fiabilidad de nuestros productos. Todos los artículos de nuestro catálogo se someten al control de calidad TRIO. No obstante, si un producto TRIO presenta defectos debidos a errores en los materiales o la fabricación, proporcionamos una garantía legal para todos los artículos del catálogo en función de las siguientes disposiciones. Los derechos legales, en especial en relación con la garantía y la protección del consumidor, no se ven limitados por ellas de ningún modo.

1. El periodo de garantía es de 24 meses y comienza el día de la compra del producto en un punto de venta autorizado.
2. Las disposiciones de garantía se aplican exclusivamente a los productos correctamente instalados y operados que se utilicen en conformidad con las condiciones de uso citadas en la descripción del producto.
3. Durante el periodo de garantía, elegiremos entre reparar o sustituir los productos que fallen debido a defectos técnicos de manera gratuita según lo que consideremos oportuno.
4. Las prestaciones de garantía no prolongan el periodo de garantía ni dan inicio a un nuevo periodo de garantía.
5. Los derechos de garantía deben reclamarse a la mayor brevedad posible una vez reconocido el defecto dentro del periodo de garantía.

## Garantía LED TRIO

Puesto que una de las ventajas de los LED es su vida útil extremadamente larga, equipamos nuestras luces LED con componentes selectos con el fin de hacer frente a los altos requisitos de calidad. Así, ponemos en nuestras luces LED también LED de calidad de la marca Osram, y de este modo alcanzamos una máxima eficiencia y fiabilidad.

Dado que estamos convencidos de la calidad de nuestros LED, concedemos para todas las luces con LED integrados fijos un periodo de garantía de tres años. Le deseamos que disfrute mucho de nuestros productos.

In quanto azienda orientata all'innovazione e proiettata nel futuro, riponiamo un grande valore nella qualità e nell'affidabilità dei nostri prodotti. Tutti gli articoli del nostro assortimento vengono sottoposti al controllo qualità TRIO. Nel caso in cui tuttavia un prodotto TRIO dovesse presentare malfunzionamenti riconducibili a difetti di materiale o di fabbricazione, in virtù della garanzia legale prevista per legge accordiamo una garanzia su tutti gli articoli dell'assortimento in conformità alle condizioni specificate di seguito, le quali non limitano in nessun modo i diritti definiti per legge, in particolare in riferimento a garanzia legale e tutela del consumatore.

1. La garanzia si estende per un periodo di 24 mesi e decorre a partire dal giorno di acquisto del prodotto presso un rivenditore autorizzato.
2. Le condizioni per la garanzia valgono solo ed esclusivamente per prodotti installati e utilizzati in conformità allo scopo d'uso previsto e alle condizioni di applicazione specificate nella descrizione del prodotto.
3. I prodotti che durante il periodo di garanzia presentano malfunzionamenti a causa di difetti tecnici vengono riparati o sostituiti gratuitamente a nostra discrezione.
4. Le prestazioni erogate in garanzia non danno origine ad estensioni del periodo di garanzia né ad una nuova garanzia.
5. I diritti di garanzia devono essere rivendicati subito dopo l'individuazione del guasto nell'ambito del periodo di garanzia.

## Garanzia sui LED TRIO

Poiché uno dei vantaggi dei LED è la lunga durata di vita, dotiamo le nostre luci LED di componenti selezionati che siano all'altezza degli elevati requisiti di qualità. Per questo motivo nelle nostre luci LED utilizziamo anche LED della marca Osram raggiungendo così un altissimo livello di efficienza e affidabilità. Essendo convinti della qualità delle nostre luci LED garantiamo su tutte le luci con LED fissi un periodo di garanzia di 3 anni. Vi auguriamo tanta soddisfazione con i nostri prodotti.

În calitate de companie inovatoare și orientată spre viitor punem mare accent pe calitatea și siguranța produselor noastre. Toate sortimentele noastre sunt supuse controlului de calitate TRIO. Dacă însă un produs TRIO prezintă defecte datorate materialului sau fabricației, acordăm în cadrul serviciului de garanție legală o garanție la toate produsele din gamă conform următoarelor reglementări. Drepturile legale îndeosebi cu privire la serviciul de garanție și protecția consumatorului nu sunt limitate prin aceasta în niciun caz.

1. Perioada de garanție este de 24 luni și începe din ziua achiziției produsului de la un comerciant autorizat.
2. Reglementările privind garanția sunt valabile exclusiv pentru produse instalate și exploatate regulamentar, care sunt utilizate conform condițiilor de utilizare menționate în descrierea produsului.



3. În timpul perioadei de garanție produsele, care funcționează necorespunzător din cauza defectunilor tehnice, sunt reparate sau înlocuite gratuit, în funcție de aprecierea noastră.
4. Serviciile de garanție cauzează sau o prelungire a perioadei de garanție sau începutul unei noi perioade de garanție.
5. Reclamațiile privind garanția trebuie să fie efectuate imediat după constatarea defectului în cadrul perioadei de garanție.

#### **Garanția TRIO pentru LED**

Deoarece unul din avantajele LED-urilor este durata de viață extrem de lungă, dotăm corpurile noastre de iluminat cu LED cu componente selectate, pentru a satisface cerințele ridicate de calitate. Astfel montăm în corpurile noastre de iluminat și LED-uri de calitate marca Osram, obținând prin aceasta un grad maxim de eficiență și siguranță.

Deoarece suntem convinși de calitatea LED-urilor noastre, acordăm o perioadă de garanție de 3 ani pentru toate corpurile de iluminat cu LED-uri încorporate. Vă dorim să vă bucurați din plin de produsele noastre.

Innovatiivisena ja tulevaisuuteen katsovana yrityksenä kiinnitämme erityistä huomiota tuotteidemme laatuun ja luotettavuuteen. Kaikki valikoimamme tuotteet ovat TRIO:n laadunvalvonnan alaisia. Siltä varalta, että jossakin TRIO-tuotteessa kaikesta huolimatta esiintyy materiaali- tai valmistusvirheiden aiheuttamia vikoja, myönnämme kaikille valikoimaamme kuuluville tuotteille lakisääteistä tuotevastuuta laajemman takuun alla kuvattavin ehdoin. Takuu ei rajoita tuotevastuuseen ja kuluttajansuojaan liittyviä tai muita lakisääteisiä oikeuksia.

1. Takuuaika on 2 vuotta alkaen päivämäärästä, jona tuote on ostettu valtuutetulta jälleenmyyjältämme.
2. Takuu koskee ainoastaan asianmukaisesti asennettuja ja käytettyjä tuotteita, joita on käytetty tuotekuvaukseen sisältyvien käyttöedellytysten mukaisesti.
3. Jos tuote rikkoutuu takuuaikana teknisen vian vuoksi, korjaamme tai vaihdamme sen maksutta harkintamme mukaan.
4. Takuun alaiset toimenpiteet eivät pidennä takuuaikaa eivätkä aiheuta uuden takuun alkamista.
5. Takuuvaatimukset on esitettävä takuun kuluessa välittömästi sen jälkeen, kun vika on tullut tietoon.

#### **TRIO:n takuu led-tuotteille**

Koska yksi led-valojen eduista on niiden erittäin pitkä käyttöikä, käytämme led-valaisimissamme tarkoin valikoituja komponentteja korkeiden laatuvaatimusten täyttämiseksi. Parhaan mahdollisen tehokkuuden ja luotettavuuden takaamiseksi käytämme led-valaisimissamme myös Osramin laadukkaita led-valoja. Olemme led-tuotteidemme laadusta niin vakuuttuneita, että myönnämme kaikille kiinteästi asennettuja led-valoja sisältäville tuotteillemme 3 vuoden takuun. Toivomme sinun nauttivan tuotteidemme käytöstä.

Jako innowacyjne i ukierunkowane na przyszłość przedsiębiorstwo przykładamy dużą wagę do jakości i niezawodności naszych produktów. Wszystkie artykuły z naszego asortymentu są poddawane kontroli jakości TRIO. Jeśli jednak mimo to któryś z produktów TRIO wykazywałby usterki wynikające z wad materiałowych lub produkcyjnych, oprócz ustawowej rękojmi udzielamy gwarancji na wszystkie artykuły z asortymentu zgodnie z poniższymi postanowieniami. Nie ogranicza ona w żaden sposób praw ustawowych, w szczególności w zakresie rękojmi i ochrony konsumentów.

1. Okres gwarancji wynosi 24 miesiące i rozpoczyna swój bieg z dniem zakupu produktu u autoryzowanego sprzedawcy.
2. Postanowienia gwarancji obowiązują wyłącznie w odniesieniu do prawidłowo zainstalowanych i eksploatowanych produktów, stosowanych w ramach warunków eksploatacji określonych w opisie produktu.
3. W okresie gwarancji produkty, które ulegną awarii z powodu wad technicznych, są przez nas nieodpłatnie naprawiane lub zastępowane, według naszej decyzji.
4. Świadczenia gwarancyjne nie skutkują przedłużeniem okresu gwarancji, ani nie uruchamiają nowej gwarancji.
5. Roszczenia gwarancyjne należy zgłosić niezwłocznie po uzyskaniu wiedzy o usterce w ramach okresu gwarancyjnego.

#### **Gwarancja TRIO LED**

Ponieważ jedną z zalet diod LED jest ich niezwykle długa żywotność, wyposażamy nasze lampy LED w wybrane komponenty spełniające wysokie wymagania jakościowe. W naszych lampach LED stosujemy wysokiej jakości diody LED marki Osram, osiągając dzięki temu maksymalny poziom wydajności i niezawodności.

Ponieważ jesteśmy przekonani o wysokiej jakości naszych lamp LED, udzielamy 3-letniej gwarancji na wszystkie lampy z zamontowanymi na stałe diodami LED. Życzymy Państwu zadowolenia z naszych produktów.

Yenilikçi ve ilerici bir şirket olarak ürünlerimizin kalite ve güvenilirliğini büyük önem veriyoruz. Portföy ürünlerimiz TRIO kalite kontrolüne tabidir. Buna rağmen bir TRIO ürününün malzeme veya imalat hataları nedeniyle kusur içermesi durumunda tüm portföy ürünlerinde aşağıdaki hükümlere göre yasal garanti sağlamaktayız. Özellikle garanti ve tüketici koruması ile ilgili yasal haklar bu nedenle kesinlikle kısıtlamaya uğramamaktadır.

1. Garanti süresi 24 aydır ve ürünün yetkili bir bayiden satın alındığı gün ile başlar.
2. Garanti hükümleri sadece nizami şekilde kurulmuş ve işletilen, ürün açıklaması altında anılan uygulama şartları altında kullanılan ürünler için geçerlidir.
3. Teknik bir kusur içeren ürünler garanti süresi içinde kendi takdirimize bağlı olarak ücretsiz olarak onarılır veya yenisiyle değiştirilir.
4. Garanti hizmetleri garanti süresinin uzatılmasına veya yeni bir garantinin sağlanmasına yol açmaz.
5. Garanti talepleri kusurun ortaya çıkmasından hemen sonra ve garanti süresi içinde ileri sürülmelidir.

#### **TRIO LED garantisi**

LED'lerin avantajlarından biri de son derece uzun kullanım ömürleri olduğundan LED lambalarımızı, yüksek kalite taleplerini yerine getirmek amacıyla seçkin bileşenlerle donatıyoruz. Bu şekilde LED lambalarımızda Osram marka kaliteli LED'ler de kullanıyor ve bu sayede verimlilik ve güvenilirlik konularında yüksek bir standarda ulaşıyoruz.

LED kalitemizden emin olduğumuz için sabit monteli LED'lere sahip lambalarımızda 3 yıl garanti sağlıyoruz.

Ürünlerimizden memnun kalmanızı diliyoruz.

Seite Page	Artikel-Nr. Product No.	EAN-Nummer EAN-Number	incl. 	#	Socket Fitting	Watt Watt	Lumen Lumen	Kelvin Kelvin	EEK (874/2012)	IP IP	Ersatzteile Spare parts
223	110400501	4017807255775		5	E14	max. 40			A++ ... E	IP20	
223	110400502	4017807255782		5	E14	max. 40			A++ ... E	IP20	
150	1121031-06	4017807146578		3	E14	max. 40			A++ ... E	IP20	9632
150	1121061-06	4017807146585		6	E14	max. 40			A++ ... E	IP20	9633
126	1170951-07	4017807213171	✓	5	G9	28	370	2800K	C	IP20	92392
126	1170951-24	4017807213188	✓	5	G9	28	370	2800K	C	IP20	92392
227	1199051-24	4017807103700		5	E14	max. 40			A++ ... E	IP20	9373-24
144	200100106	4017807255652		1	E27	max. 60			A++ ... E	IP20	
144	200100107	4017807255645		1	E27	max. 60			A++ ... E	IP20	
374	200970124	4017807211832		1	E14	max. 40			A++ ... E	IP20	92396
164	202200104	4017807292510		1	E14	max. 40			A++ ... E	IP20	
164	202200161	4017807292527		1	E14	max. 40			A++ ... E	IP20	
164	202200162	4017807292534		1	E14	max. 40			A++ ... E	IP20	
380	202400106	4017807244908		1	E14	max. 40			A++ ... E	IP20	92579
376	203100100	4017807232462		1	E27	max. 40			A++ ... E	IP20	92486
383	204000106	4017807295672		1	E14	max. 40			A++ ... E	IP20	92769
120	204700101	4017807276541		1	E27	max. 60			A++ ... E	IP20	92717-13
134	207800100	4017807189148		1	E14	max. 40			A++ ... E	IP20	92259-20
152	208400106	4017807240184		1	E14	max. 40			A++ ... E	IP20	
400	210710107	4017807244953	✓	1	G9	28	370	2800K	C	IP20	92580
400	212410207	4017807218077	✓	2	G9	28	370	2800K	C	IP20	92527 92527-01
402	216070107	4017807212198	✓	1	G9	28	370	2800K	C	IP20	9797
402	216070124	4017807212228	✓	1	G9	28	370	2800K	C	IP20	9797
394	220110205	4017807229912	✓	2	COB-LED	2,3	150	3200K	A+	IP20	
412	220515587	4017807210224	✓	1	SMD-LED	5,7	290	6100K	A	IP20	
394	220810201	4017807258363	✓	2	SMD-LED	3,2	300	3000K	A+	IP20	92335
394	220810205	4017807258370	✓	2	SMD-LED	3,2	300	3000K	A+	IP20	92335
392	221570206	4017807281163	✓	2	SMD-LED	3,2	300	3000K	A+	IP20	
392	221570207	4017807281170	✓	2	SMD-LED	3,2	300	3000K	A+	IP20	
392	221570228	4017807281187	✓	2	SMD-LED	3,2	300	3000K	A+	IP20	
68	221770105	4017807244960	✓	1	SMD-LED	7	630	3000K	A+	IP20	G2217
323	222370306	4017807237955	✓	1	COB-LED	3	240	3500K	A+	IP20	92534-13 92534-15 92534-18
398	222970207	4017807264203	✓	2	SMD-LED	3,2	300	3000K	A+	IP20	
398	223070207	4017807264210	✓	2	SMD-LED	3,2	300	3000K	A+	IP20	
396	223170201	4017807267358	✓	2	SMD-LED	5	450	3000K	A+	IP20	
396	223170206	4017807267365	✓	2	SMD-LED	5	450	3000K	A+	IP20	
396	223170207	4017807267372	✓	2	SMD-LED	5	450	3000K	A+	IP20	
390	223410107	4017807303032	✓	1	SMD-LED	4,5	430	3000K	A+	IP20	
390	223410131	4017807303025	✓	1	SMD-LED	4,5	430	3000K	A+	IP20	
390	223410132	4017807306309	✓	1	SMD-LED	4,5	430	3000K	A+	IP20	
352	223570207	4017807268089	✓	2	SMD-LED	4,5	400	3000K	A+	IP20	92687
352	223570228	4017807268096	✓	2	SMD-LED	4,5	400	3000K	A+	IP20	92687
318	223810209	4017807303841	✓	1	SMD-LED	3,2	300	3000K	A+	IP20	
318	223810279	4017807299472	✓	1	SMD-LED	3,2	300	3000K	A+	IP20	
318	223810289	4017807299489	✓	1	SMD-LED	3,2	300	3000K	A+	IP20	
331	224610206	4017807225013	✓	2	SMD-LED	4,5	400	3000K	A+	IP20	92451
331	224610306	4017807225020	✓	3	SMD-LED	4,5	400	3000K	A+	IP20	92451
331	224670106	4017807225006	✓	1	SMD-LED	4,5	400	3000K	A+	IP20	92451
386	225210104	4017807256314	✓	1	SMD-LED	8	600	3000K	A	IP20	

Seite Page	Artikel-Nr. Product No.	EAN-Nummer EAN-Number	incl. 	#	Socket Fitting	Watt Watt	Lumen Lumen	Kelvin Kelvin	EEK (874/2012)	IP IP	Ersatzteile Spare parts
386	225210106	4017807256321	✓	1	SMD-LED	8	600	3000K	A	IP20	
386	225210107	4017807256338	✓	1	SMD-LED	8	600	3000K	A	IP20	
110	225370102	4017807275407	✓	1	SMD-LED	4,5	400	3000K	A+	IP20	
397	225510207	4017807277913	✓	2	SMD-LED	3,2	300	3000K	A+	IP20	
395	225610607	4017807277920	✓	6	SMD-LED	1	100	3000K	A++	IP20	
393	227170101	4017807267716	✓	1	SMD-LED	4,5	400	3000K	A+	IP20	
393	227170102	4017807267730	✓	1	SMD-LED	4,5	400	3000K	A+	IP20	
393	227170105	4017807267723	✓	1	SMD-LED	4,5	400	3000K	A+	IP20	
464	227280101	4017807298253	✓	1	SMD-LED	5	550	3500K	A+	IP20	
464	227280102	4017807298260	✓	1	SMD-LED	5	550	3500K	A+	IP20	
332	227410106	4017807236378	✓	1	SMD-LED	4,5	430	3000K	A+	IP20	92532
332	227410206	4017807237412	✓	2	SMD-LED	4,5	430	3000K	A+	IP20	92532
332	227410306	4017807237429	✓	3	COB-LED	5	400	3000K	A+	IP20	92532
328	227970106	4017807268997	✓	1	SMD-LED	4,5	400	3000K	A+	IP20	92676-12
328	227970206	4017807266245	✓	2	SMD-LED	4,5	400	3000K	A+	IP20	92676-26
328	227970406	4017807266252	✓	4	SMD-LED	4,5	400	3000K	A+	IP20	92676-45
398	228370106	4017807267747	✓	1	SMD-LED	7	650	3000K	A+	IP20	
334	228610506	4017807245820	✓	1	COB-LED	5	400	3000K	A+	IP20	92572 92572-20
404	2501021-01	4017807130669		2	E14	max. 40			A++ ... E	IP20	9273-01
402	2502211-07	4017807103908		1	E14	max. 60			A++ ... E	IP20	9413-01
402	2502211-24	4017807103922		1	E14	max. 60			A++ ... E	IP20	9413-24
405	2522011-06	4017807080797		1	E14	max. 40			A++ ... E	IP20	92105
405	2523011-01	4017807094756		1	E14	max. 40			A++ ... E	IP20	9327-01
405	2523011-24	4017807094770		1	E14	max. 40			A++ ... E	IP20	9327-24
404	2524011-07	4017807067170		1	E27	max. 60			A++ ... E	IP20	9232
403	2529211-07	4017807151077		1	E14	max. 60			A++ ... E	IP20	9573-07
403	2529211-24	4017807151084		1	E14	max. 60			A++ ... E	IP20	9573-24
407	25701	4017807275742	✓	1	SMD-LED	2	100	3000K	A	IP20	
407	25719	4017807273328	✓	1	SMD-LED	2	100	3000K	A	IP20	
407	25751	4017807273304	✓	1	SMD-LED	2	100	3000K	A	IP20	
407	25787	4017807273298	✓	1	SMD-LED	2	100	3000K	A	IP20	
407	25793	4017807273311	✓	1	SMD-LED	2	100	3000K	A	IP20	
407	25990	4017807273410	✓	1	SMD-LED	2,8	130	3000K	A	IP20	
407	25991	4017807273403	✓	1	SMD-LED	2,8	130	3000K	A	IP20	
399	2606011-07	4017807064216	✓	1	R7S	80	1375	2800K	C	IP20	9328
400	2611021-07	4017807147780	✓	2	GU10	35	240	2800K	D	IP20	
401	261910105	4017807180763	✓	1	G9	18	204	2800K	C	IP20	
126	2670911-07	4017807213225	✓	1	G9	28	370	2800K	C	IP20	92379
126	2670911-24	4017807213232	✓	1	G9	28	370	2800K	C	IP20	92379
142	271170201	4017807247251		1	E14	max. 40			A++ ... E	IP20	92765-01
			✓	1	SMD-LED	3,2	300	3000K	A+		
142	271170202	4017807247268		1	E14	max. 40			A++ ... E	IP20	92765-02
			✓	1	SMD-LED	3,2	300	3000K	A+		
142	271170214	4017807247282		1	E14	max. 40			A++ ... E	IP20	92765-02
			✓	1	SMD-LED	3,2	300	3000K	A+		
108	272480101	4017807282597	✓	1	SMD-LED	4,5	430	3000K	A+	IP20	
108	272480107	4017807282603	✓	1	SMD-LED	4,5	430	3000K	A+	IP20	
108	272490101	4017807282610	✓	1	SMD-LED	4,5	430	3000K	A+	IP20	
108	272490107	4017807282627	✓	1	SMD-LED	4,5	430	3000K	A+	IP20	
411	272970401	4017807284652	✓	1	SMD-LED	4	350	3000K	A+	IP20	
411	272970487	4017807284669	✓	1	SMD-LED	4	350	3000K	A+	IP20	
411	272970701	4017807284676	✓	1	SMD-LED	7	600	3000K	A+	IP20	
411	272970787	4017807284683	✓	1	SMD-LED	7	600	3000K	A+	IP20	
412	273070401	4017807284690	✓	1	SMD-LED	4	350	3000K	A+	IP20	

Seite Page	Artikel-Nr. Product No.	EAN-Nummer EAN-Number	incl. 	#	Socket Fitting	Watt Watt	Lumen Lumen	Kelvin Kelvin	EEK (874/2012)	IP IP	Ersatzteile Spare parts
412	273070701	4017807284706	✓	1	SMD-LED	7	600	3000K	A+	IP20	
412	273071301	4017807284713	✓	1	SMD-LED	13	1100	3000K	A	IP20	
412	273071801	4017807284720	✓	1	SMD-LED	18	1500	3000K	A	IP20	
411	273170301	4017807284737	✓	3	SMD-LED	1	80	3000K	A++	IP20	
411	273170387	4017807284744	✓	3	SMD-LED	1	80	3000K	A++	IP20	
411	273170401	4017807284751	✓	4	SMD-LED	1	80	3000K	A++	IP20	
411	273170487	4017807284768	✓	4	SMD-LED	1	80	3000K	A++	IP20	
70	273190106	4017807293272	✓	1	SMD-LED	3,2	300	3000K	A+	IP20	
70	273190206	4017807293289	✓	2	SMD-LED	3,2	300	3000K	A+	IP20	
70	273190306	4017807293296	✓	3	SMD-LED	3,2	300	3000K	A+	IP20	
408	273271201	4017807329087	✓	1	SMD-LED	10	850	3000K	A	IP20	
408	273271801	4017807329094	✓	1	SMD-LED	15,5	1300	3000K	A+	IP20	
413	273370307	4017807284799	✓	3	SMD-LED	3	200	3000K	A+	IP20	
410	273471201	4017807329063	✓	1	SMD-LED	10,5	950	3000K	A	IP20	
410	273471801	4017807329070	✓	1	SMD-LED	15,5	1370	3000K	A+	IP20	
92	274191005	4017807281927	✓	1	SMD-LED	10	900	3000K	A	IP20	
336	274670105	4017807293968	✓	1	SMD-LED	4,5	430	3000K	A+	IP20	
336	274670205	4017807293975	✓	2	SMD-LED	4,5	430	3000K	A+	IP20	
336	274670305	4017807293982	✓	3	SMD-LED	4,5	430	3000K	A+	IP20	
62	275290106	4017807295702	✓	1	SMD-LED	4,5	430	3000K	A+	IP20	
62	275290206	4017807295719	✓	2	SMD-LED	4,5	430	3000K	A+	IP20	
62	275290306	4017807295726	✓	3	SMD-LED	4,5	430	3000K	A+	IP20	
324	275470107	4017807299571	✓	1	SMD-LED	4,3	390	3000K	A+	IP20	
324	275470207	4017807299588	✓	2	SMD-LED	4,3	390	3000K	A+	IP20	
337	275770107	4017807292664	✓	1	SMD-LED	4,5	340	3000K	A+	IP20	
337	275770207	4017807292671	✓	2	SMD-LED	4,5	340	3000K	A+	IP20	
337	275770307	4017807292688	✓	3	SMD-LED	4,5	340	3000K	A+	IP20	
58	276370206	4017807298895	✓	2	SMD-LED	8	800	3000K	A+	IP20	
54	276970206	4017807261714	✓	2	SMD-LED	4,5	400	3000K	A+	IP20	92681-30
86	277690206	4017807282153	✓	2	SMD-LED	5	500	3000K	A+	IP20	
52	278490207	4017807281286	✓	2	SMD-LED	4,5	430	3000K	A+	IP20	
329	279070107	4017807281125	✓	1	SMD-LED	4,5	430	3000K	A+	IP20	
329	279070207	4017807281132	✓	2	SMD-LED	4,5	430	3000K	A+	IP20	
329	279070307	4017807281149	✓	3	SMD-LED	4,5	430	3000K	A+	IP20	
76	279670207	4017807286878	✓	2	SMD-LED	4,3	460	3000K	A+	IP20	
76	279690207	4017807286960	✓	2	SMD-LED	10	900	3000K	A+	IP20	
76	C279690207	4017807295870	✓	2	SMD-LED	10	900	3000K	A+	IP20	
388	279770104	4017807275346	✓	1	SMD-LED	4	380	3000K	A++	IP20	
388	279770107	4017807275353	✓	1	SMD-LED	4	380	3000K	A++	IP20	
388	279770108	4017807275360	✓	1	SMD-LED	4	380	3000K	A++	IP20	
506	2800011-06	4017807147421	✓	1	G9	28	370	2800K	C	IP21	9584
509	2801021-06	4017807147407		2	E14	max. 40			A++ ... E	IP21	9578
509	2801021-07	4017807147414		2	E14	max. 40			A++ ... E	IP21	9577
507	2802011-07	4017807147452	✓	1	G9	28	370	2800K	C	IP21	9583
509	2803021-06	4017807147599		2	E14	max. 40			A++ ... E	IP21	9579-01
509	2803031-06	4017807147605		3	E14	max. 40			A++ ... E	IP21	9579
496	280470106	4017807183900	✓	1	E14	9	450	2700K	A	IP21	92169-06
496	280470206	4017807183924	✓	2	E14	6	470	3000K	A+	IP21	92169-06
507	280610106	4017807244809	✓	1	G9	33	458	2800K	C	IP44	92648
506	280710106	4017807244762	✓	1	G9	28	370	2800K	C	IP44	92647
506	280710107	4017807244779	✓	1	G9	28	370	2800K	C	IP44	92647-01
506	280710206	4017807244786	✓	2	G9	28	370	2800K	C	IP44	92647
506	280710207	4017807244793	✓	2	G9	28	370	2800K	C	IP44	92647-01
506	280870106	4017807243734	✓	1	G9	33	458	2800K	C	IP44	92643
506	280870107	4017807243741	✓	1	G9	33	458	2800K	C	IP44	92643-01



Seite Page	Artikel-Nr. Product No.	EAN-Nummer EAN-Number	incl. 	#	Sockel Fitting	Watt Watt	Lumen Lumen	Kelvin Kelvin	EEK (874/2012)	IP IP	Ersatzteile Spare parts
506	280870206	4017807243758	✓	2	G9	33	458	2800K	C	IP44	92643
506	280870207	4017807243765	✓	2	G9	33	458	2800K	C	IP44	92643-01
500	281570606	4017807245967	✓	1	SMD-LED	6	600	3000K	A+	IP44	
500	281570906	4017807245950	✓	1	SMD-LED	9	970	3000K	A+	IP44	
494	281670206	4017807245974	✓	2	SMD-LED	6	600	3000K	A+	IP44	
494	281670207	4017807245981	✓	2	SMD-LED	6	600	3000K	A+	IP44	
501	281770906	4017807246018	✓	1	SMD-LED	9	900	3000K	A++	IP44	
501	281771206	4017807246025	✓	1	SMD-LED	12	1200	3000K	A++	IP44	
500	281810106	4017807244816	✓	1	SMD-LED	8	500	3500K	A+	IP44	92649
498	281910106	4017807244823	✓	1	SMD-LED	4,5	400	3000K	A+	IP44	92651
498	281980106	4017807244830	✓	1	SMD-LED	3,2	300	3000K	A+	IP44	92651
498	281980206	4017807244847	✓	2	SMD-LED	3,2	300	3000K	A+	IP44	92651
498	282080106	4017807244861	✓	1	SMD-LED	4	280	3500K	A+	IP44	92650
498	282080206	4017807244878	✓	2	SMD-LED	3,2	300	3000K	A+	IP44	92650
498	282180106	4017807244885	✓	1	SMD-LED	3,2	300	3000K	A+	IP44	92650
498	282180206	4017807244892	✓	2	SMD-LED	4	280	3500K	A+	IP44	92650
495	282210106	4017807245998	✓	1	SMD-LED	2,3	230	3000K	A++	IP44	
495	282210107	4017807246063	✓	1	SMD-LED	2,3	230	3000K	A++	IP44	
497	282310106	4017807280791	✓	1	SMD-LED	3,2	300	3000K	A+	IP44	92736
497	282310206	4017807280807	✓	2	SMD-LED	3,2	300	3000K	A+	IP44	92736
493	282410106	4017807280821	✓	1	SMD-LED	3,2	300	3000K	A+	IP44	
493	282410206	4017807280838	✓	2	SMD-LED	3,2	300	3000K	A+	IP44	
492	282510106	4017807302998	✓	1	SMD-LED	4,5	430	3000K	A+	IP44	
492	282510206	4017807303001	✓	2	SMD-LED	4,5	430	3000K	A+	IP44	
492	282510306	4017807303018	✓	3	SMD-LED	4,5	430	3000K	A+	IP44	
502	282670106	4017807293302	✓	1	SMD-LED	9	460	4000K	A	IP21	
491	282710106	4017807302530	✓	1	SMD-LED	3,6	260	3000K	A+	IP44	
491	282710206	4017807302547	✓	2	SMD-LED	2,8	180	3000K	A+	IP44	
490	282810106	4017807302554	✓	1	SMD-LED	3,4	260	3000K	A+	IP44	
490	282810206	4017807302561	✓	2	SMD-LED	3,4	260	3000K	A+	IP44	
144	300100106	4017807259841		1	E27	max. 60			A++ ... E	IP20	
144	300100107	4017807259858		1	E27	max. 60			A++ ... E	IP20	
216	300203005	4017807203271		1	E27	max. 60			A++ ... E	IP20	
216	300204005	4017807203158		1	E27	max. 60			A++ ... E	IP20	
156	300400106	4017807219883		1	E27	max. 60			A++ ... E	IP20	
116	300500104	4017807267112		1	E27	max. 60			A++ ... E	IP20	
116	300500107	4017807262421		1	E27	max. 60			A++ ... E	IP20	
116	300500109	4017807262438		1	E27	max. 60			A++ ... E	IP20	
237	300600101	4017807261073		1	E27	max. 60			A++ ... E	IP20	
237	300600102	4017807261080		1	E27	max. 60			A++ ... E	IP20	
237	300600187	4017807261097		1	E27	max. 60			A++ ... E	IP20	
167	300700101	4017807298659		1	E27	max. 60			A++ ... E	IP20	
167	300700102	4017807298666		1	E27	max. 60			A++ ... E	IP20	
167	300900101	4017807298673		1	E27	max. 60			A++ ... E	IP20	
167	300900102	4017807298680		1	E27	max. 60			A++ ... E	IP20	
218	301100178	4017807293500		1	E14	max. 40			A++ ... E	IP20	
218	301100378	4017807293517		3	E14	max. 40			A++ ... E	IP20	
218	301190178	4017807293524		1	E27	max. 60			A++ ... E	IP20	
234	301400101	4017807195422		1	E27	max. 60			A++ ... E	IP20	92270-01
234	301400112	4017807195446		1	E27	max. 60			A++ ... E	IP20	92270-12
234	301400115	4017807195453		1	E27	max. 60			A++ ... E	IP20	92270-15
234	301400124	4017807195651		1	E27	max. 60			A++ ... E	IP20	92270-24
234	301400192	4017807195460		1	E27	max. 60			A++ ... E	IP20	92270-92
169	301500104	4017807293531		1	E27	max. 60			A++ ... E	IP20	92767-04
169	301500107	4017807293548		1	E27	max. 60			A++ ... E	IP20	92767-07

Seite Page	Artikel-Nr. Product No.	EAN-Nummer EAN-Number	incl. 	#	Socket Fitting	Watt Watt	Lumen Lumen	Kelvin Kelvin	EEK (874/2012)	IP IP	Ersatzteile Spare parts
232	301700107	4017807196009		1	E27	max. 60			A++ ... E	IP20	9408-01
232	301700108	4017807196016		1	E27	max. 60			A++ ... E	IP20	9408-01
212	301800107	4017807262537		1	E27	max. 60			A++ ... E	IP20	92700
212	301800129	4017807282740		1	E27	max. 60			A++ ... E	IP20	92700
226	301900104	4017807299304		1	E27	max. 60			A++ ... E	IP20	92295
226	301900107	4017807299311		1	E27	max. 60			A++ ... E	IP20	92295
226	301900162	4017807303209		1	E27	max. 60			A++ ... E	IP20	92295
163	302000104	4017807292633		1	E27	max. 60			A++ ... E	IP20	
163	302000161	4017807292640		1	E27	max. 60			A++ ... E	IP20	
163	302000162	4017807292657		1	E27	max. 60			A++ ... E	IP20	
171	302100102	4017807286991		1	E27	max. 60			A++ ... E	IP20	92745
171	302100161	4017807287004		1	E27	max. 60			A++ ... E	IP20	92745
171	302100162	4017807287011		1	E27	max. 60			A++ ... E	IP20	92745
164	302200104	4017807292541		1	E27	max. 40			A++ ... E	IP20	
164	302200161	4017807292558		1	E27	max. 40			A++ ... E	IP20	
164	302200162	4017807292565		1	E27	max. 40			A++ ... E	IP20	
182	302300104	4017807288445		1	E14	max. 40			A++ ... E	IP20	
182	302300161	4017807286700		1	E14	max. 40			A++ ... E	IP20	
182	302300162	4017807286717		1	E14	max. 40			A++ ... E	IP20	
235	302400106	4017807301045		1	E27	max. 40			A++ ... E	IP20	92780
215	302400107	4017807295788		1	E27	max. 60			A++ ... E	IP20	
215	302400164	4017807295795		1	E27	max. 60			A++ ... E	IP20	
168	302600161	4017807286786		1	E27	max. 60			A++ ... E	IP20	92752
168	302600162	4017807286793		1	E27	max. 60			A++ ... E	IP20	92752
170	302700102	4017807286526		1	E14	max. 40			A++ ... E	IP20	92741
225	302800706	4017807228632		7	E14	max. 40			A++ ... E	IP20	92515A 92515B 92515C
176	302900102	4017807292497		1	E27	max. 60			A++ ... E	IP20	92779
141	303300101	4017807288292		1	E27	max. 60			A++ ... E	IP20	
141	303300102	4017807288308		1	E27	max. 60			A++ ... E	IP20	
141	303300114	4017807288315		1	E27	max. 60			A++ ... E	IP20	
141	303300301	4017807242485		3	E27	max. 60			A++ ... E	IP20	92722
141	303300302	4017807242492		3	E27	max. 60			A++ ... E	IP20	92722-02
141	303300314	4017807244410		3	E27	max. 60			A++ ... E	IP20	92722-14
148	303400306	4017807248272		3	E27	max. 60			A++ ... E	IP20	92657
184	303700104	4017807286601		1	E14	max. 40			A++ ... E	IP20	
184	303700161	4017807286618		1	E14	max. 40			A++ ... E	IP20	
184	303700162	4017807286625		1	E14	max. 40			A++ ... E	IP20	
174	303800102	4017807286540		1	E14	max. 40			A++ ... E	IP20	92740
174	303800161	4017807286557		1	E14	max. 40			A++ ... E	IP20	92740
174	303800162	4017807286564		1	E14	max. 40			A++ ... E	IP20	92740
177	303800517	4017807292503		5	E14	max. 40			A++ ... E	IP20	92740
136	303900100	4017807227604		1	E27	max. 40			A++ ... E	IP20	
136	303900116	4017807227611		1	E27	max. 40			A++ ... E	IP20	
136	303900192	4017807227628		1	E27	max. 60			A++ ... E	IP20	
236	304000106	4017807216448		1	E27	max. 60			A++ ... E	IP21	92391
236	304000115	4017807216455		1	E27	max. 60			A++ ... E	IP20	92391-15
236	304000142	4017807216479		1	E27	max. 60			A++ ... E	IP20	92391-42
236	304000151	4017807216462		1	E27	max. 60			A++ ... E	IP20	92391-51
236	304000192	4017807216486		1	E27	max. 60			A++ ... E	IP20	92391-92
236	304100100	4017807247411		1	E27	max. 60			A++ ... E	IP20	92634
236	304100106	4017807247404		1	E27	max. 60			A++ ... E	IP20	92634-06
236	304100192	4017807247428		1	E27	max. 60			A++ ... E	IP20	92634-92
136	304200100	4017807290332		1	E27	max. 40			A++ ... E	IP20	

Seite Page	Artikel-Nr. Product No.	EAN-Nummer EAN-Number	incl. 	#	Sockel Fitting	Watt Watt	Lumen Lumen	Kelvin Kelvin	EEK (874/2012)	IP IP	Ersatzteile Spare parts
136	304200116	4017807290349		1	E27	max. 40			A++ ... E	IP20	
136	304200192	4017807290356		1	E27	max. 40			A++ ... E	IP20	
136	304290100	4017807290363		1	E27	max. 60			A++ ... E	IP20	
233	304300107	4017807279986		1	E27	max. 40			A++ ... E	IP20	
172	304500104	4017807286151		1	E27	max. 28			A++ ... E	IP20	92740
172	304500161	4017807286168		1	E27	max. 28			A++ ... E	IP20	92740
172	304500162	4017807286175		1	E27	max. 28			A++ ... E	IP20	92740
120	304700101	4017807275667		1	E27	max. 60			A++ ... E	IP20	92717-17
120	304700301	4017807275681		3	E27	max. 60			A++ ... E	IP20	92717-17
120	304790101	4017807275674		1	E27	max. 60			A++ ... E	IP20	92717-23
220	304800100	4017807277937		1	E27	max. 60			A++ ... E	IP20	92720-00
220	304800142	4017807277944		1	E27	max. 60			A++ ... E	IP20	92720-42
221	304900100	4017807277951		1	E27	max. 60			A++ ... E	IP20	92721-00
221	304900142	4017807277968		1	E27	max. 60			A++ ... E	IP20	92721-42
36	305200101	4017807301182		1	E27	max. 60			A++ ... E	IP20	92728-01
40	305200179	4017807281064		1	E27	max. 60			A++ ... E	IP20	92728-79
42	305200189	4017807281071		1	E27	max. 60			A++ ... E	IP20	92728-89
36	305200301	4017807303223		3	E14	max. 40			A++ ... E	IP20	92727-01
40	305200379	4017807287066		3	E14	max. 40			A++ ... E	IP20	92727-79
42	305200389	4017807287073		3	E14	max. 40			A++ ... E	IP20	92727-89
36	305290101	4017807301199		1	E14	max. 40			A++ ... E	IP20	92727-01
40	305290179	4017807287042		1	E14	max. 40			A++ ... E	IP20	92727-79
42	305290189	4017807287059		1	E14	max. 40			A++ ... E	IP20	92727-89
132	305600100	4017807303247		1	E27	max. 40			A++ ... E	IP20	
132	305600101	4017807306316		1	E27	max. 40			A++ ... E	IP20	
132	305600113	4017807303254		1	E27	max. 40			A++ ... E	IP20	
210	305700109	4017807329131		1	E27	max. 60			A++ ... E	IP20	
210	305700179	4017807329148		1	E27	max. 60			A++ ... E	IP20	
210	305700189	4017807329155		1	E27	max. 60			A++ ... E	IP20	
217	306200101	4017807280869		1	E27	max. 40			A++ ... E	IP20	
217	306200105	4017807280876		1	E27	max. 40			A++ ... E	IP20	
217	306300101	4017807280883		1	E27	max. 60			A++ ... E	IP20	
217	306300105	4017807280890		1	E27	max. 60			A++ ... E	IP20	
118	306400179	4017807286465		1	E14	max. 40			A++ ... E	IP20	
118	306400189	4017807286472		1	E14	max. 40			A++ ... E	IP20	
146	306500107	4017807280975		1	E27	max. 60			A++ ... E	IP20	
214	307300105	4017807285734		1	E27	max. 60			A++ ... E	IP20	
214	307300162	4017807285758		1	E27	max. 60			A++ ... E	IP20	
209	307400101	4017807285789		1	E27	max. 60			A++ ... E	IP20	
209	307400102	4017807285796		1	E27	max. 60			A++ ... E	IP20	
209	307400107	4017807285802		1	E27	max. 60			A++ ... E	IP20	
209	307400162	4017807285819		1	E27	max. 60			A++ ... E	IP20	
162	307500104	4017807303193		1	E27	max. 40			A++ ... E	IP20	
162	307500161	4017807298789		1	E27	max. 40			A++ ... E	IP20	
162	307500162	4017807298796		1	E27	max. 40			A++ ... E	IP20	
166	307600101	4017807237290		1	E27	max. 60			A++ ... E	IP20	
166	307600124	4017807238228		1	E27	max. 60			A++ ... E	IP20	
134	307800100	4017807189155		1	E27	max. 60			A++ ... E	IP20	92258-30
134	307804100	4017807190083		1	E27	max. 60			A++ ... E	IP20	92258-40
134	307900100	4017807285468		1	E27	max. 60			A++ ... E	IP20	
208	308000106	4017807288858		1	E27	max. 60			A++ ... E	IP20	
208	308000132	4017807288827		1	E27	max. 60			A++ ... E	IP20	
208	308000162	4017807288841		1	E27	max. 60			A++ ... E	IP20	
130	308210407	4017807236583	✓	4	G9	28	370	2800K	C	IP20	92542
130	308210424	4017807236613	✓	4	G9	28	370	2800K	C	IP20	92542

Seite Page	Artikel-Nr. Product No.	EAN-Nummer EAN-Number	incl. 	#	Sockel Fitting	Watt Watt	Lumen Lumen	Kelvin Kelvin	EEK (874/2012)	IP IP	Ersatzteile Spare parts
224	308300106	4017807219999		1	E27	max. 60			A++ ... E	IP20	
152	308400206	4017807240191		2	E14	max. 40			A++ ... E	IP20	
138	308500101	4017807255928		1	E27	max. 60			A++ ... E	IP20	
138	308500102	4017807255935		1	E27	max. 60			A++ ... E	IP20	
138	308500142	4017807255942		1	E27	max. 60			A++ ... E	IP20	
224	309400506	4017807189797		5	E14	max. 40			A++ ... E	IP20	92294
216	309600106	4017807274226		1	E14	max. 40			A++ ... E	IP20	92716
216	309600109	4017807274233		1	E14	max. 40			A++ ... E	IP20	92716
157	309700106	4017807196467		1	E27	max. 60			A++ ... E	IP20	92324
38	315200109	4017807288001		1	E27	max. 60			A++ ... E	IP20	92735-09
35	315200131	4017807306118		1	E27	max. 60			A++ ... E	IP20	92735-31
38	315200179	4017807287998		1	E27	max. 60			A++ ... E	IP20	92735-79
38	315200189	4017807288018		1	E27	max. 60			A++ ... E	IP20	92735-89
34	315300106	4017807301212		1	E27	max. 60			A++ ... E	IP20	92737-01
34	315390106	4017807301205		1	E14	max. 40			A++ ... E	IP20	92736-01
45	315400162	4017807301168		1	E27	max. 60			A++ ... E	IP20	92739-62
45	315400188	4017807301175		1	E27	max. 60			A++ ... E	IP20	92739-88
45	315490162	4017807301144		1	E14	max. 40			A++ ... E	IP20	92738-62
45	315490188	4017807301151		1	E14	max. 40			A++ ... E	IP20	92738-88
228	322210307	4017807247299	✓	3	E14	4	320	3000K	A+	IP20	92594
228	322210407	4017807247305	✓	4	E14	4	320	3000K	A+	IP20	92594
200	322510406	4017807217827	✓	4	COB-LED	5	300	3000K	A	IP20	92409
318	323810109	4017807305852	✓	1	SMD-LED	19	1700	3000K	A+	IP20	
318	C323810109	4017807336368	✓	1	SMD-LED	19	1700	3000K	A+	IP20	
318	323810179	4017807305869	✓	1	SMD-LED	19	1700	3000K	A+	IP20	
318	C323810179	4017807336375	✓	1	SMD-LED	19	1700	3000K	A+	IP20	
318	323810189	4017807305876	✓	1	SMD-LED	19	1700	3000K	A+	IP20	
318	C323810189	4017807336382	✓	1	SMD-LED	19	1700	3000K	A+	IP20	
194	324390407	4017807292701	✓	4	SMD-LED	4,5	430	3000K	A+	IP20	92439
194	324390408	4017807297997	✓	4	SMD-LED	4,5	430	3000K	A+	IP20	92439
194	324390507	4017807292718	✓	5	SMD-LED	4,5	430	3000K	A+	IP20	92439
199	324510406	4017807274547	✓	4	SMD-LED	4,6	430	3000K	A+	IP20	
115	324610187	4017807257168	✓	1	COB-LED	6,5	570	3000K	A+	IP20	
292	324810407	4017807257649	✓	4	E14	4	320	3000K	A+	IP20	98249
292	324810428	4017807257854	✓	4	E14	4	320	3000K	A+	IP20	98249
46	325113005	4017807292817	✓	1	SMD-LED	9	800	3000K	A+	IP20	
46	325114005	4017807296938	✓	1	SMD-LED	11	1000	3000K	A+	IP20	
192	326311006	4017807261790	✓	10	SMD-LED	3,2	300	3000K	A+	IP20	92682-01
202	327910105	4017807251036	✓	1	COB-LED	4,5	350	3000K	A+	IP20	
202	327910205	4017807245639	✓	2	COB-LED	4,5	350	3000K	A+	IP20	
202	327910405	4017807245646	✓	4	COB-LED	4,5	350	3000K	A+	IP20	
202	327930505	4017807245653	✓	5	COB-LED	4,5	350	3000K	A+	IP20	
280	328210406	4017807256352	✓	4	SMD-LED	3,8	350	3100K	A+	IP20	
198	329610407	4017807261776	✓	4	SMD-LED	4,5	400	3000K	A+	IP20	92688 92688-01
222	340100106	4017807244434		1	E27	max. 40			A++ ... E	IP20	92591
124	3401011-07	4017807057690		1	E27	max. 60			A++ ... E	IP20	9242
124	3401051-07	4017807189629		5	E14	max. 40			A++ ... E	IP20	92226
222	340190106	4017807246902		1	E27	max. 60			A++ ... E	IP20	92591-28
129	3402011-24	4017807053265		1	E27	max. 60			A++ ... E	IP20	92125
129	3402021-24	4017807196795		2	E27	max. 60			A++ ... E	IP20	92275
232	3407011-07	4017807103724		1	E27	max. 60			A++ ... E	IP20	9408-01
232	3407011-24	4017807103731		1	E27	max. 60			A++ ... E	IP20	9408-24
235	3414011-01	4017807107791		1	E27	max. 60			A++ ... E	IP20	9430-01
235	3414011-24	4017807107838		1	E27	max. 60			A++ ... E	IP20	9430-24



Seite Page	Artikel-Nr. Product No.	EAN-Nummer EAN-Number	incl. 	#	Socket Fitting	Watt Watt	Lumen Lumen	Kelvin Kelvin	EEK (874/2012)	IP IP	Ersatzteile Spare parts
238	3490400-00	4017807062465		1	E27	max. 60			A++ ... E	IP20	
238	3490400-15	4017807254723		1	E27	max. 60			A++ ... E	IP20	
238	3490400-18	4017807081527		1	E27	max. 60			A++ ... E	IP20	
238	3490400-19	4017807254716		1	E27	max. 60			A++ ... E	IP20	
238	3490400-92	4017807198638		1	E27	max. 60			A++ ... E	IP20	
239	3490500-00	4017807062472		1	E27	max. 60			A++ ... E	IP20	
239	3490600-00	4017807062489		1	E27	max. 60			A++ ... E	IP20	
239	3491400-00	4017807081541		1	E27	max. 60			A++ ... E	IP20	
238	3590010-01	4017807062496		1	E27	max. 60			A++ ... E	IP20	
154	361300905	4017807209334		9	E14	max. 40			A++ ... E	IP20	
96	370610407	4017807299687	✓	4	SMD-LED	4,5	430	3000K	A+	IP20	
229	371010307	4017807281750	✓	3	E14	6	470	3000K	A+	IP20	92734-01
229	371010308	4017807281767	✓	3	E14	6	470	3000K	A+	IP20	92734-01
229	371010328	4017807281774	✓	3	E14	6	470	3000K	A+	IP20	92734-28
229	371010407	4017807281781	✓	4	E14	6	470	3000K	A+	IP20	92734-01
229	371010408	4017807281798	✓	4	E14	6	470	3000K	A+	IP20	92734-01
229	371010428	4017807281804	✓	4	E14	6	470	3000K	A+	IP20	92734-28
294	371410407	4017807261875	✓	4	E14	4	320	3000K	A+	IP20	92680
286	371510407	4017807285017	✓	4	G9	3,5	300	3000K	A+	IP20	92739
286	371510408	4017807301267	✓	4	G9	3,5	300	3000K	A+	IP20	92739
94	371810305	4017807294064	✓	3	SMD-LED	11	1100	3000K	A+	IP20	
242	371910406	4017807294279	✓	4	SMD-LED	4,3	400	3000K	A+	IP20	
78	372010506	4017807294200	✓	5	SMD-LED	4,3	400	3000K	A+	IP20	
72	372294505	4017807297546	✓	1	SMD-LED	45	4500	3000K	A+	IP20	
276	372810406	4017807262353	✓	4	SMD-LED	3,8	350	3100K	A+	IP20	
278	372810501	4017807266269	✓	5	SMD-LED	3,8	350	3100K	A+	IP20	
276	372810506	4017807266276	✓	5	SMD-LED	3,8	350	3100K	A+	IP20	
60	372910106	4017807299267	✓	1	SMD-LED	20	1800	3000K	A+	IP20	
60	C372910106	4017807336504	✓	1	SMD-LED	20	1800	3000K	A+	IP20	
70	373111006	4017807281095	✓	10	SMD-LED	3,2	300	3000K	A+	IP20	
70	C373111006	4017807287301	✓	1	SMD-LED	3,2	300	3000K	A+	IP20	
92	374112505	4017807281934	✓	1	SMD-LED	25	2300	3000K	A	IP20	
92	C374112505	4017807336450	✓	1	SMD-LED	25	2300	3000K	A	IP20	
274	374210406	4017807288391	✓	4	SMD-LED	3,5	370	3000K	A++	IP20	
88	374310506	4017807282351	✓	5	SMD-LED	5	450	3000K	A+	IP20	
88	C374310506	4017807336436	✓	5	SMD-LED	5	450	3000K	A+	IP20	
248	374410406	4017807267310	✓	4	SMD-LED	4,5	400	3000K	A+	IP20	
106	374910106	4017807306019	✓	1	SMD-LED	30	2500	3000K+	A	IP20	
							4500K+6500K				
230	3751021-07	4017807137712		2	E14	max. 40			A++ ... E	IP20	9350
230	3751031-07	4017807137729		3	E14	max. 40			A++ ... E	IP20	9350
230	3751031-24	4017807182255		3	E14	max. 40			A++ ... E	IP20	9350-24
230	3751041-07	4017807137736		4	E14	max. 40			A++ ... E	IP20	9350
230	3751041-24	4017807181081		4	E14	max. 40			A++ ... E	IP20	9350-24
230	3751051-07	4017807169027		5	E14	max. 40			A++ ... E	IP20	9350
230	3751051-24	4017807181098		5	E14	max. 40			A++ ... E	IP20	9350-24
62	375210506	4017807295733	✓	5	SMD-LED	4,5	430	3000K	A+	IP20	
63	C375210506	4017807336481	✓	5	SMD-LED	4,5	430	3000K	A+	IP20	
100	375910406	4017807286007	✓	4	SMD-LED	3,8	350	3000K	A+	IP20	
188	376013606	4017807282085	✓	1	SMD-LED	36	3500	3000K	A+	IP20	
56	376310406	4017807298918	✓	4	SMD-LED	7	700	3000K	A+	IP20	
204	376410402	4017807280906	✓	4	SMD-LED	4,5	430	3000K	A+	IP20	
204	C376410402	4017807294484	✓	4	SMD-LED	4,5	430	3000K	A+	IP20	
204	376410406	4017807280913	✓	4	SMD-LED	4,5	430	3000K	A+	IP20	
204	C376410406	4017807294491	✓	4	SMD-LED	4,5	430	3000K	A+	IP20	

Seite Page	Artikel-Nr. Product No.	EAN-Nummer EAN-Number	incl. 	#	Socket Fitting	Watt Watt	Lumen Lumen	Kelvin Kelvin	EEK (874/2012)	IP IP	Ersatzteile Spare parts
112	376510302	4017807280920	✓	3	SMD-LED	4,5	430	3000K	A+	IP20	
112	376510306	4017807280937	✓	3	SMD-LED	4,5	430	3000K	A+	IP20	
206	376610302	4017807280944	✓	3	SMD-LED	4,5	430	3000K	A+	IP20	
206	376610307	4017807280951	✓	3	SMD-LED	4,5	430	3000K	A+	IP20	
206	376610309	4017807280968	✓	3	SMD-LED	4,5	430	3000K	A+	IP20	
205	376790507	4017807281040	✓	5	SMD-LED	4,5	430	3000K	A+	IP20	
205	376790528	4017807281057	✓	5	SMD-LED	4,5	430	3000K	A+	IP20	
64	376810107	4017807299045	✓	1	SMD-LED	18	1800	3000K	A+	IP20	
65	C376810107	4017807336337	✓	1	SMD-LED	18	1800	3000K	A+	IP20	
54	376910506	4017807261721	✓	5	SMD-LED	4,5	400	3000K	A+	IP20	92681-110
82	377110407	4017807277760	✓	4	SMD-LED	4,5	400	3000K	A+	IP20	92764
82	377110408	4017807278903	✓	4	SMD-LED	4,5	400	3000K	A+	IP20	92764-08
201	377310307	4017807274622	✓	3	SMD-LED	4,5	430	3000K	A+	IP20	92707
190	377590205	4017807293937	✓	1	SMD-LED	30	2800	3000K	A	IP20	
86	377610106	4017807282160	✓	1	SMD-LED	24	2200	3000K	A+	IP20	
196	377690105	4017807296280	✓	1	SMD-LED	20	1900	3000K	A+	IP20	
84	378210107	4017807302776	✓	1	SMD-LED	4,5	380	3000K	A+	IP20	
84	378210307	4017807302806	✓	3	SMD-LED	4,5	380	3000K	A+	IP20	
84	378210407	4017807302790	✓	4	SMD-LED	4,5	380	3000K	A+	IP20	
50	378390707	4017807303070	✓	7	SMD-LED	3,2	300	3000K	A+	IP20	
52	378490607	4017807281293	✓	6	SMD-LED	4,5	430	3000K	A+	IP20	
193	378790405	4017807273922	✓	4	SMD-LED	4,5	430	3000K	A+	IP20	92723
193	378790505	4017807273939	✓	5	SMD-LED	4,5	430	3000K	A+	IP20	92723-01
197	379090505	4017807282245	✓	5	SMD-LED	4,5	430	3000K	A+	IP20	
68	379411805	4017807267860	✓	1	SMD-LED	18	1800	3000K	A+	IP20	
66	379412705	4017807256277	✓	1	SMD-LED	27	2700	3000K	A+	IP20	
74	379610107	4017807286915	✓	1	SMD-LED	29	2800	3000K	A+	IP20	
74	C379610107	4017807295948	✓	1	SMD-LED	29	2800	3000K	A+	IP20	
74	379613607	4017807286953	✓	2	SMD-LED	18	1800	3000K	A+	IP20	
74	C379613607	4017807295894	✓	2	SMD-LED	18	1800	3000K	A+	IP20	
144	400100106	4017807255690		1	E27	max. 60			A++ ... E	IP20	
144	400100107	4017807255683		1	E27	max. 60			A++ ... E	IP20	
116	400500104	4017807268621		1	E14	max. 18			A++ ... E	IP20	
116	400500107	4017807268638		1	E14	max. 18			A++ ... E	IP20	
116	400500109	4017807268645		1	E14	max. 18			A++ ... E	IP20	
440	400800101	4017807260380		1	E27	max. 60			A++ ... E	IP20	92664-01
440	400800102	4017807255751		1	E27	max. 60			A++ ... E	IP20	92664-02
142	401100101	4017807276121		1	E27	max. 60			A++ ... E	IP20	92782-01
142	401100102	4017807276138		1	E27	max. 60			A++ ... E	IP20	92782-02
142	401100114	4017807276145		1	E27	max. 60			A++ ... E	IP20	92782-14
432	401400101	4017807277111		1	E27	max. 60			A++ ... E	IP20	
432	401400102	4017807273946		1	E27	max. 60			A++ ... E	IP20	
150	4021051-06	4017807146554		5	E14	max. 40			A++ ... E	IP20	9634
302	402400201	4017807229868		2	GU10	max. 25			A++ ... E	IP20	
302	402400207	4017807231434		2	GU10	max. 25			A++ ... E	IP20	
455	403010307	4017807161540	✓	3	G9	28	370	2800K	C	IP20	9616
148	403400106	4017807248289		1	E27	max. 40			A++ ... E	IP20	92659
454	4035011-04	4017807090604		1	E27	max. 60			A++ ... E	IP20	92174
454	4035011-07	4017807090611		1	E27	max. 60			A++ ... E	IP20	92174
454	4035011-08	4017807090628		1	E27	max. 60			A++ ... E	IP20	92174
146	406500107	4017807280982		1	E27	max. 60			A++ ... E	IP20	
436	407300106	4017807285826		1	E27	max. 42			A++ ... E	IP20	
438	407400101	4017807285840		1	E27	max. 60			A++ ... E	IP20	
179	407700114	4017807298758		1	E14	max. 40			A++ ... E	IP20	
179	407700161	4017807298765		1	E14	max. 40			A++ ... E	IP20	

Seite Page	Artikel-Nr. Product No.	EAN-Nummer EAN-Number	incl. 	#	Socket Fitting	Watt Watt	Lumen Lumen	Kelvin Kelvin	EEK (874/2012)	IP IP	Ersatzteile Spare parts
434	407800131	4017807299557		1	E27	max. 60			A++ ... E	IP20	
434	407800132	4017807303216		1	E27	max. 60			A++ ... E	IP20	
152	408400206	4017807240207		2	E14	max. 40			A++ ... E	IP20	
158	413210306	4017807195606	✓	3	G9	28	370	2800K	C	IP20	92319
120	414700101	4017807280623		1	E27	max. 60			A++ ... E	IP20	
442	416600200	4017807208498		2	E14	max. 40			A++ ... E	IP20	
429	4200011-06	4017807105650		1	E27	max. 75			A++ ... E	IP20	913240
446	420490107	4017807295337	✓	1	SMD-LED	6	560	3000K	A+	IP20	9243-01
428	421100301	4017807194494		3	E27	max. 60			A++ ... E	IP20	922875-01
428	421100302	4017807194500		3	E27	max. 60			A++ ... E	IP20	922875-02
447	421410305	4017807236309	✓	3	SMD-LED	4,5	400	3000K	A+	IP20	92426
418	421910207	4017807267532	✓	4	SMD-LED	4,5	400	3000K	A+	IP20	92685
			✓	1	SMD-LED	4,5	400	3000K	A+		92685-01
418	421910228	4017807267549	✓	4	SMD-LED	4,5	400	3000K	A+	IP20	92685
			✓	1	SMD-LED	4,5	400	3000K	A+		92685-01
417	422510201	4017807286182	✓	1	SMD-LED	30	2100	3000K	A	IP20	92753
			✓	1	SMD-LED	5	400	3000K	A+		92753-01
417	422510207	4017807286205	✓	1	SMD-LED	30	2100	3000K	A	IP20	92753
			✓	1	SMD-LED	5	400	3000K	A+		92753-01
425	424290107	4017807306200	✓	1	SMD-LED	20	1800	3000K	A+	IP20	92788
450	424510187	4017807236705	✓	1	SMD-LED	5	480	3100K	A+	IP20	
451	424590107	4017807257021	✓	1	SMD-LED	5	480	3100K	A+	IP20	
115	424610187	4017807258745	✓	1	SMD-LED	4,5	400	3000K	A+	IP20	
292	424810107	4017807257687	✓	1	E14	4	320	3000K	A+	IP20	98249
292	424810128	4017807257861	✓	1	E14	4	320	3000K	A+	IP20	98249
292	424810207	4017807257700	✓	2	E14	4	320	3000K	A+	IP20	98249
292	424810228	4017807257878	✓	2	E14	4	320	3000K	A+	IP20	98249
110	425310102	4017807261912	✓	1	SMD-LED	4,5	400	3000K	A+	IP20	
419	426410207	4017807244717	✓	1	SMD-LED	20	1650	3000K	A	IP20	
			✓	1	SMD-LED	5	460	3000K	A+		
419	426410208	4017807244724	✓	1	SMD-LED	20	1650	3000K	A	IP20	
			✓	1	SMD-LED	5	460	3000K	A+		
452	427410101	4017807291490	✓	1	SMD-LED	6	670	3000K	A+	IP20	
452	427410142	4017807291506	✓	1	SMD-LED	6	670	3000K	A+	IP20	
426	427511801	4017807274332	✓	1	SMD-LED	18	1800	3000K	A+	IP20	
426	427511802	4017807274349	✓	1	SMD-LED	18	1800	3000K	A+	IP20	
426	427511887	4017807279511	✓	1	SMD-LED	18	1800	3000K	A+	IP20	
280	428210106	4017807256376	✓	1	SMD-LED	3,8	350	3100K	A+	IP20	
280	428210206	4017807256390	✓	2	SMD-LED	3,8	350	3100K	A+	IP20	
420	429110104	4017807267518	✓	1	SMD-LED	20	1750	3000K	A	IP20	92694
420	429110107	4017807267525	✓	1	SMD-LED	20	1750	3000K	A	IP20	92694
424	429910107	4017807273984	✓	4	SMD-LED	4,5	400	3000K	A+	IP20	
422	431912107	4017807211061	✓	1	R7S	230	4650	2800K	C	IP20	92383
			✓	1	G9	28	370	2800K	C		92383-01
											92383-02
422	431912108	4017807211078	✓	1	R7S	230	4650	2800K	C	IP20	92383
			✓	1	G9	28	370	2800K	C		92383-01
											92383-02
422	431912124	4017807211085	✓	1	R7S	230	4650	2800K	C	IP20	92383
			✓	1	G9	28	370	2800K	C		92383-01
											92383-02
423	4344021-24	4017807053364	✓	1	R7S	230	4650	2800K	C	IP20	9356-24
			✓	1	G9	28	370	2800K	C		9214-24
421	4348021-06	4017807149555	✓	1	R7S	230	4650	2700K	C	IP20	9566
			✓	1	G9	28	370	2800K	C		95661

Seite Page	Artikel-Nr. Product No.	EAN-Nummer EAN-Number	incl. 	#	Sockel Fitting	Watt Watt	Lumen Lumen	Kelvin Kelvin	EEK (874/2012)	IP IP	Ersatzteile Spare parts
423	436410208	4017807212013	✓	1	R7S	230	4650	2800K	C	IP20	92377
			✓	1	G9	28	370	2800K	C		92377-01
423	436410224	4017807210767	✓	1	R7S	230	4650	2800K	C	IP20	92378
			✓	1	G9	28	370	2800K	C		92378-01
421	438410207	4017807218114	✓	1	R7S	230	4650	2800K	C	IP20	92407
			✓	1	G9	28	370	2800K	C		92407-01
454	4403011-04	4017807053012	✓	1	GY6.35	50	850	2800K	C	IP20	
454	4403011-07	4017807053029	✓	1	GY6.35	50	850	2800K	C	IP20	
454	4403011-08	4017807053036	✓	1	GY6.35	50	850	2800K	C	IP20	
126	4470921-07	4017807213157	✓	2	G9	28	370	2800K	C	IP20	92379
126	4470921-24	4017807213164	✓	2	G9	28	370	2800K	C	IP20	92379
124	4601011-07	4017807057676		1	E27	max. 60			A++ ... E	IP20	9242
129	4602011-24	4017807053272		1	E27	max. 150			A++ ... E	IP20	9282
129	4602021-24	4017807196801		1	E27	max. 100			A++ ... E	IP20	92274
				1	E14	max. 40			A++ ... E		92274-01
142	461100101	4017807247220		1	E27	max. 60			A++ ... E	IP20	92597-01
142	461100102	4017807247237		1	E27	max. 60			A++ ... E	IP20	92597-02
142	461100114	4017807247244		1	E27	max. 60			A++ ... E	IP20	92597-14
138	461200101	4017807257489		1	E27	max. 60			A++ ... E	IP20	92665-01
138	461200102	4017807255737		1	E27	max. 60			A++ ... E	IP20	92665-02
138	461200142	4017807257496		1	E27	max. 60			A++ ... E	IP20	92665-42
96	470690307	4017807299700	✓	3	SMD-LED	4,5	430	3000K	A+	IP20	
78	472010306	4017807294194	✓	3	SMD-LED	4,3	400	3000K	A+	IP20	
72	472290105	4017807305753	✓	1	SMD-LED	20	1800	3000K	A	IP20	
108	472490201	4017807282566	✓	2	SMD-LED	4,5	430	3000K	A+	IP20	
108	472490207	4017807281415	✓	2	SMD-LED	4,5	430	3000K	A+	IP20	
60	472910106	4017807299281	✓	1	SMD-LED	20	1800	3000K	A+	IP20	
254	473190307	4017807302691	✓	3	SMD-LED	4,7	470	3000K	A+	IP20	
256	473190331	4017807302707	✓	1	SMD-LED	4,7	470	3000K	A+	IP20	
92	474112505	4017807281941	✓	1	SMD-LED	25	2300	3000K	A	IP20	
88	474310306	4017807281903	✓	3	SMD-LED	5	450	3000K	A+	IP20	
100	475910106	4017807295818	✓	1	SMD-LED	3,8	350	3000K	A+	IP20	
56	476310206	4017807298956	✓	2	SMD-LED	12	1200	3000K	A+	IP20	
104	476412506	4017807281606	✓	1	SMD-LED	25	2300	3000K	A	IP20	
54	476910506	4017807261738	✓	4	SMD-LED	4,5	400	3000K	A+	IP20	92681-17
			✓	1	SMD-LED	4,5	400	3000K	A+		92681-49
54	476990506	4017807261745	✓	5	SMD-LED	3,2	300	3000K	A+	IP20	92681-112
82	477110207	4017807277838	✓	2	SMD-LED	4,5	400	3000K	A+	IP20	92764
82	477110208	4017807278910	✓	2	SMD-LED	4,5	400	3000K	A+	IP20	92764-08
444	477710106	4017807295764	✓	1	SMD-LED	11	1000	3000K	A+	IP20	
50	478390607	4017807303087	✓	6	SMD-LED	3,2	300	3000K	A+	IP20	
52	478490407	4017807281309	✓	4	SMD-LED	4,5	430	3000K	A+	IP20	
416	478610207	4017807273762	✓	1	SMD-LED	40	3200	3000K	A+	IP20	92733
			✓	1	SMD-LED	6	480	3000 - 5500K	A+		92733-01
262	478610306	4017807282023	✓	3	SMD-LED	4,5	430	3000K	A+	IP20	92766
449	478610307	4017807287837	✓	3	SMD-LED	4,5	430	3000K	A+	IP20	92766
260	478710306	4017807261462	✓	3	SMD-LED	4,5	400	3000K	A+	IP20	92677
66	479411805	4017807256284	✓	1	SMD-LED	18	1800	3000K	A+	IP20	
74	479610207	4017807286922	✓	2	SMD-LED	4,3	460	3000K	A+	IP20	
455	4912011-07	4017807116816	✓	1	G9	28	370	2800K	C	IP20	
455	4912011-08	4017807116823	✓	1	G9	28	370	2800K	C	IP20	
482	5000011-07	4017807092042		1	E14	max. 40			A++ ... E	IP20	9316
144	500100106	4017807255720		1	E27	max. 60			A++ ... E	IP20	
144	500100107	4017807255713		1	E27	max. 60			A++ ... E	IP20	
116	500500104	4017807268669		1	E14	max. 18			A++ ... E	IP20	



Seite Page	Artikel-Nr. Product No.	EAN-Nummer EAN-Number	incl. 	#	Sockel Fitting	Watt Watt	Lumen Lumen	Kelvin Kelvin	EEK (874/2012)	IP IP	Ersatzteile Spare parts
116	500500107	4017807268676		1	E14	max. 18			A++ ... E	IP20	
116	500500109	4017807268683		1	E14	max. 18			A++ ... E	IP20	
440	500800101	4017807260397		1	E14	max. 40			A++ ... E	IP20	
440	500800102	4017807255768		1	E14	max. 40			A++ ... E	IP20	
141	501100101	4017807246810		1	E14	max. 40			A++ ... E	IP20	
141	501100102	4017807246827		1	E14	max. 40			A++ ... E	IP20	
141	501100114	4017807246834		1	E14	max. 40			A++ ... E	IP20	
432	501400101	4017807277128		1	E14	max. 40			A++ ... E	IP20	
432	501400102	4017807273960		1	E14	max. 40			A++ ... E	IP20	
178	502000119	4017807286755		1	E14	max. 40			A++ ... E	IP20	
178	502000161	4017807286762		1	E14	max. 40			A++ ... E	IP20	
178	502000162	4017807286779		1	E14	max. 40			A++ ... E	IP20	
164	502200104	4017807292602		1	E14	max. 40			A++ ... E	IP20	
164	502200161	4017807292619		1	E14	max. 40			A++ ... E	IP20	
164	502200162	4017807292626		1	E14	max. 40			A++ ... E	IP20	
182	502500104	4017807286809		1	E14	max. 40			A++ ... E	IP20	
182	502500161	4017807288452		1	E14	max. 40			A++ ... E	IP20	
182	502500162	4017807286816		1	E14	max. 40			A++ ... E	IP20	
170	502700102	4017807286533		1	E14	max. 40			A++ ... E	IP20	92741
471	5027011-01	4017807017366		1	E27	max. 18			A++ ... E	IP20	
471	5027011-17	4017807051360		1	E27	max. 18			A++ ... E	IP20	
471	5027011-47	4017807124941		1	E27	max. 18			A++ ... E	IP20	
470	5028010-01	4017807051414		1	E14	max. 18			A++ ... E	IP20	
470	5028010-02	4017807051421		1	E14	max. 18			A++ ... E	IP20	
470	5028010-17	4017807051438		1	E14	max. 18			A++ ... E	IP20	
470	5028010-47	4017807051445		1	E14	max. 18			A++ ... E	IP20	
470	5029010-01	4017807051377		1	E27	max. 40			A++ ... E	IP20	
470	5029010-17	4017807051391		1	E27	max. 40			A++ ... E	IP20	
470	5029010-47	4017807051407		1	E27	max. 40			A++ ... E	IP20	
182	503300104	4017807286663		1	E14	max. 40			A++ ... E	IP20	
182	503300161	4017807286670		1	E14	max. 40			A++ ... E	IP20	
182	503300162	4017807286687		1	E14	max. 40			A++ ... E	IP20	
148	503400106	4017807248296		1	E27	max. 40			A++ ... E	IP20	
176	503500104	4017807286724		1	E14	max. 40			A++ ... E	IP20	92742
176	503500161	4017807286731		1	E14	max. 40			A++ ... E	IP20	92742
176	503500162	4017807286748		1	E14	max. 40			A++ ... E	IP20	92742
184	503700104	4017807286632		1	E14	max. 40			A++ ... E	IP20	
184	503700161	4017807286649		1	E14	max. 40			A++ ... E	IP20	
184	503700162	4017807286656		1	E14	max. 40			A++ ... E	IP20	
174	503800102	4017807286571		1	E14	max. 40			A++ ... E	IP20	92740
174	503800161	4017807286588		1	E14	max. 40			A++ ... E	IP20	92740
174	503800162	4017807286595		1	E14	max. 40			A++ ... E	IP20	92740
132	505600100	4017807335767		1	E14	max. 40			A++ ... E	IP20	
132	505600101	4017807335774		1	E14	max. 40			A++ ... E	IP20	
132	505600113	4017807335781		1	E14	max. 40			A++ ... E	IP20	
118	506400179	4017807286489		1	E14	max. 40			A++ ... E	IP20	
118	506400189	4017807286496		1	E14	max. 40			A++ ... E	IP20	
146	506500107	4017807280999		1	E14	max. 40			A++ ... E	IP20	
436	507300106	4017807285833		1	E14	max. 28			A++ ... E	IP20	
438	507400101	4017807285857		1	E27	max. 60			A++ ... E	IP20	
179	507700114	4017807298727		1	E14	max. 40			A++ ... E	IP20	
179	507700161	4017807298734		1	E14	max. 40			A++ ... E	IP20	
134	507800100	4017807189193		1	E14	max. 40			A++ ... E	IP20	92258-25
434	507800131	4017807329162		1	E14	max. 40			A++ ... E	IP20	
434	507800132	4017807329179		1	E14	max. 40			A++ ... E	IP20	

Seite Page	Artikel-Nr. Product No.	EAN-Nummer EAN-Number	incl. 	#	Sockel Fitting	Watt Watt	Lumen Lumen	Kelvin Kelvin	EEK (874/2012)	IP IP	Ersatzteile Spare parts
138	508500101	4017807255959		1	E14	max. 40			A++ ... E	IP20	
138	508500102	4017807255966		1	E14	max. 40			A++ ... E	IP20	
138	508500142	4017807255973		1	E14	max. 40			A++ ... E	IP20	
141	511100101	4017807246841		1	E27	max. 60			A++ ... E	IP20	
141	511100102	4017807246858		1	E27	max. 60			A++ ... E	IP20	
141	511100114	4017807246865		1	E27	max. 60			A++ ... E	IP20	
150	5121031-06	4017807147667		3	E14	max. 40			A++ ... E	IP20	9635
120	514700101	4017807280630		1	E27	max. 60			A++ ... E	IP20	92717-17
34	515300106	4017807301236		1	E14	max. 40			A++ ... E	IP20	92736-01
44	515500100	4017807301106		1	E14	max. 40			A++ ... E	IP20	92730-00
44	515500101	4017807301113		1	E14	max. 40			A++ ... E	IP20	92730-01
44	515500162	4017807301120		1	E14	max. 40			A++ ... E	IP20	92730-62
44	515500188	4017807301137		1	E14	max. 40			A++ ... E	IP20	92730-88
442	516600100	4017807208504		1	E14	max. 40			A++ ... E	IP20	
446	520490107	4017807295344	✓	1	SMD-LED	6	560	3000K	A+	IP20	9243-01
467	522520101	4017807226768	✓	1	SMD-LED	3,6	200	3000K	A	IP20	
467	522520102	4017807226775	✓	1	SMD-LED	3,6	200	3000K	A	IP20	
467	522520187	4017807226782	✓	1	SMD-LED	3,6	200	3000K	A	IP20	
466	522610101	4017807211153	✓	1	COB-LED	5	320	3000K	A	IP20	
466	522610187	4017807211184	✓	1	COB-LED	5	320	3000K	A	IP20	
462	523410101	4017807259780	✓	1	SMD-LED	7	600	4100K	A+	IP20	
462	523410187	4017807259797	✓	1	SMD-LED	7	600	4100K	A+	IP20	
458	523910101	4017807226867	✓	1	SMD-LED	7	470	2500 - 4000K	A	IP20	
458	523910102	4017807226874	✓	1	SMD-LED	7	470	2500 - 4000K	A	IP20	
450	524510101	4017807233087	✓	1	SMD-LED	3	300	3100K	A+	IP20	
450	524510102	4017807229431	✓	1	SMD-LED	3	300	3100K	A+	IP20	
450	524510117	4017807229455	✓	1	SMD-LED	3	300	3100K	A+	IP20	
450	524510187	4017807229448	✓	1	SMD-LED	3	300	3100K	A+	IP20	
451	524590106	4017807256994	✓	1	SMD-LED	3	300	3100K	A+	IP20	
451	524590107	4017807257007	✓	1	SMD-LED	3	300	3100K	A+	IP20	
115	524610187	4017807257137	✓	1	SMD-LED	4,5	400	3000K	A+	IP20	
292	524810107	4017807257663	✓	1	E14	4	320	3000K	A+	IP20	98249
292	524810128	4017807257885	✓	1	E14	4	320	3000K	A+	IP20	98249
466	524910106	4017807229486	✓	1	COB-LED	5	300	3000K	A	IP20	
460	525110142	4017807259810	✓	1	SMD-LED	7	600	4100K	A+	IP20	
46	525112005	4017807292824	✓	1	SMD-LED	4	370	3000K	A+	IP20	
46	525113005	4017807296297	✓	1	SMD-LED	9	800	3000K	A+	IP20	
110	525310102	4017807261929	✓	1	SMD-LED	4,5	400	3000K	A+	IP20	
460	526290187	4017807275995	✓	1	SMD-LED	5,5	500	3000 + 5000K	A+	IP20	
461	526410101	4017807281019	✓	1	SMD-LED	5	500	3000K	A+	IP20	
461	526410102	4017807281026	✓	1	SMD-LED	5	500	3000K	A+	IP20	
461	526410187	4017807281033	✓	1	SMD-LED	5	500	3000K	A+	IP20	
463	526610101	4017807262551	✓	1	COB-LED	5	450	3000K	A+	IP20	
464	527290101	4017807291438	✓	1	SMD-LED	5	550	3500K	A+	IP20	
464	527290102	4017807291445	✓	1	SMD-LED	5	550	3500K	A+	IP20	
452	527410101	4017807291452	✓	1	SMD-LED	6	670	3000K	A+	IP20	
452	527410142	4017807291513	✓	1	SMD-LED	6	670	3000K	A+	IP20	
469	527810101	4017807274356	✓	1	SMD-LED	4,4	450	3000K	A+	IP20	
469	527810106	4017807274363	✓	1	SMD-LED	4,4	450	3000K	A+	IP20	
469	527810107	4017807275025	✓	1	SMD-LED	4,4	450	3000K	A+	IP20	
469	527810115	4017807275018	✓	1	SMD-LED	4,4	450	3000K	A+	IP20	
469	527810119	4017807277012	✓	1	SMD-LED	4,4	450	3000K	A+	IP20	
456	527920101	4017807276046	✓	1	COB-LED	5	500	3000K	A+	IP20	
456	527920102	4017807276053	✓	1	COB-LED	5	500	3000K	A+	IP20	
280	528210106	4017807256413	✓	1	SMD-LED	3,8	350	3100K	A+	IP20	

Seite Page	Artikel-Nr. Product No.	EAN-Nummer EAN-Number	incl. 	#	Socket Fitting	Watt Watt	Lumen Lumen	Kelvin Kelvin	EEK (874/2012)	IP IP	Ersatzteile Spare parts
468	528310102	4017807244557	✓	1	SMD-LED	3,8	350	3100K	A+	IP20	
468	528310107	4017807244564	✓	1	SMD-LED	3,8	350	3100K	A+	IP20	
468	528380107	4017807245899	✓	1	SMD-LED	3,8	350	3100K	A+	IP20	
473	528990506	4017807242287	✓	1	SMD-LED	5	350	3000K	A	IP20	92586-17
473	528990806	4017807242300	✓	1	SMD-LED	8	600	3000K	A	IP20	92586-20
475	529310103	4017807261998	✓	1	E14	4	320	3000K	A+	IP20	92672
475	529310106	4017807262001	✓	1	E14	4	320	3000K	A+	IP20	92672
475	529310107	4017807262018	✓	1	E14	4	320	3000K	A+	IP20	92672-07
475	529310128	4017807262025	✓	1	E14	4	320	3000K	A+	IP20	92672-28
475	529690100	4017807262032	✓	1	SMD-LED	4,5	400	3000K	A+	IP20	92671-00
475	529690106	4017807262063	✓	1	SMD-LED	4,5	400	3000K	A+	IP20	92671-03
475	529690107	4017807262070	✓	1	SMD-LED	4,5	400	3000K	A+	IP20	92671-07
122	529710106	4017807242560	✓	1	SMD-LED	5	400	3000K	A	IP20	92565-15
472	529990103	4017807248340	✓	1	SMD-LED	5	400	3000K	A	IP20	92584
472	529990106	4017807248357	✓	1	SMD-LED	5	400	3000K	A	IP20	92584
472	529990107	4017807248364	✓	1	SMD-LED	5	400	3000K	A	IP20	92584
472	529990124	4017807248371	✓	1	SMD-LED	5	400	3000K	A	IP20	92584
471	5410011-42	4017807107869	✓	1	GY6.35	50	850	2800K	C	IP20	92284
471	5410011-87	4017807107876	✓	1	GY6.35	50	850	2800K	C	IP20	92284
124	5601011-07	4017807057683		1	E14	max. 40			A++ ... E	IP20	9355
129	5602021-24	4017807053494		2	E14	max. 40			A++ ... E	IP20	9292
146	556500107	4017807281002		1	E27	max. 60			A++ ... E	IP20	
459	570190102	4017807298222	✓	1	SMD-LED	5	600	3000/4000/5000K	A+	IP20	
459	570190187	4017807298239	✓	1	SMD-LED	5	600	3000/4000/5000K	A+	IP20	
96	570610107	4017807299694	✓	1	SMD-LED	4,5	430	3000K	A+	IP20	
78	572010206	4017807294187	✓	2	SMD-LED	4,3	400	3000K	A+	IP20	
72	572290105	4017807305746	✓	1	SMD-LED	10	900	3000K	A+	IP20	
474	572711005	4017807267808	✓	1	SMD-LED	7,5	550	3500K	A	IP20	
278	572810101	4017807262322	✓	1	SMD-LED	3,8	350	3100K	A+	IP20	
276	572810106	4017807262339	✓	1	SMD-LED	3,8	350	3100K	A+	IP20	
60	572910106	4017807303162	✓	1	SMD-LED	14,5	1300	3000K	A+	IP20	
254	573190107	4017807302677	✓	1	SMD-LED	4,7	470	3000K	A+	IP20	
256	573190131	4017807302684	✓	1	SMD-LED	4,7	470	3000K	A+	IP20	
468	573510101	4017807276671	✓	1	SMD-LED	3	320	3000K	A++	IP20	
468	573510102	4017807276688	✓	1	SMD-LED	3	320	3000K	A++	IP20	
468	573510115	4017807276695	✓	1	SMD-LED	3	320	3000K	A++	IP20	
468	573510187	4017807276701	✓	1	SMD-LED	3	320	3000K	A++	IP20	
463	573910101	4017807275636	✓	1	SMD-LED	4,8	450	3000K	A+	IP20	
463	573910102	4017807275643	✓	1	SMD-LED	4,8	450	3000K	A+	IP20	
463	573910106	4017807275650	✓	1	SMD-LED	4,8	450	3000K	A+	IP20	
482	574090103	4017807269901	✓	1	E14	4	320	3000K	A+	IP20	92679
482	574090106	4017807268966	✓	1	E14	4	320	3000K	A+	IP20	92679
482	574090107	4017807268973	✓	1	E14	4	320	3000K	A+	IP20	92679-01
482	574090128	4017807268980	✓	1	E14	4	320	3000K	A+	IP20	92679-01
92	574191005	4017807281958	✓	1	SMD-LED	10	900	3000K	A	IP20	
88	574310106	4017807281910	✓	1	SMD-LED	5	450	3000K	A+	IP20	
90	574391006	4017807285918	✓	1	SMD-LED	10	900	3000K	A+	IP20	
100	575910106	4017807295825	✓	1	SMD-LED	3,8	350	3000K	A+	IP20	
56	576390206	4017807298949	✓	2	SMD-LED	8	800	3000K	A+	IP20	
104	576410806	4017807287257	✓	1	SMD-LED	6	600	3000K	A+	IP20	
104	576491806	4017807281613	✓	1	SMD-LED	18	1600	3000K	A	IP20	
54	576910306	4017807261752	✓	3	SMD-LED	4,5	400	3000K	A+	IP20	92681-40
82	577110107	4017807277821	✓	1	SMD-LED	4,5	400	3000K	A+	IP20	92764
82	577110108	4017807278927	✓	1	SMD-LED	4,5	400	3000K	A+	IP20	92764-08

Seite Page	Artikel-Nr. Product No.	EAN-Nummer EAN-Number	incl. 	#	Socket Fitting	Watt Watt	Lumen Lumen	Kelvin Kelvin	EEK (874/2012)	IP IP	Ersatzteile Spare parts
462	577390101	4017807279559	✓	1	SMD-LED	4	360	3000K	A+	IP20	
			✓	1	SMD-LED	4	400	5000K	A+		
462	577390102	4017807279566	✓	1	SMD-LED	4	360	3000K	A+	IP20	
			✓	1	SMD-LED	4	400	5000K	A+		
462	577390187	4017807280357	✓	1	SMD-LED	4	360	3000K	A+	IP20	
			✓	1	SMD-LED	4	400	5000K	A+		
444	577710106	4017807295771	✓	1	SMD-LED	7	700	3000K	A+	IP20	
84	578210107	4017807302899	✓	1	SMD-LED	4,5	380	3000K	A+	IP20	
50	578390307	4017807303094	✓	3	SMD-LED	3,2	300	3000K	A+	IP20	
52	578490207	4017807281316	✓	2	SMD-LED	4,5	430	3000K	A+	IP20	
262	578610206	4017807282030	✓	2	SMD-LED	4,5	430	3000K	A+	IP20	92766
260	578710106	4017807261455	✓	1	SMD-LED	4,5	400	3000K	A+	IP20	92677
66	579410705	4017807260427	✓	1	SMD-LED	7	600	3000K	A+	IP20	
66	579411105	4017807256291	✓	1	SMD-LED	11	850	3000K	A	IP20	
74	579610207	4017807286939	✓	2	SMD-LED	3	310	3000K	A++	IP20	
388	579790104	4017807275285	✓	1	SMD-LED	4	380	3000K	A++	IP20	
388	579790107	4017807275322	✓	1	SMD-LED	4	380	3000K	A++	IP20	
388	579790108	4017807275339	✓	1	SMD-LED	4	380	3000K	A++	IP20	
483	5900011-04	4017807108026		1	E14	max. 40			A++ ... E	IP20	9424
483	5900011-07	4017807108033		1	E14	max. 40			A++ ... E	IP20	9424
483	5900011-08	4017807108040		1	E14	max. 40			A++ ... E	IP20	9424
483	5901011-07	4017807108057		1	E14	max. 40			A++ ... E	IP21	9426
481	5908011-07	4017807135749		1	E14	max. 40			A++ ... E	IP20	9262-01
487	5914011-01	4017807150445		1	E14	max. 60			A++ ... E	IP20	92281-01
487	5914011-02	4017807150452		1	E14	max. 60			A++ ... E	IP20	92281
487	5914011-10	4017807150469		1	E14	max. 60			A++ ... E	IP20	92281-10
487	5914011-42	4017807150476		1	E14	max. 60			A++ ... E	IP20	
481	592000107	4017807166705	✓	1	G9	28	370	2800K	C	IP20	9704
481	592000108	4017807166712	✓	1	G9	28	370	2800K	C	IP20	9704
479	5922011-07	4017807081770		1	E27	max. 60			A++ ... E	IP20	9309
476	5925011-04	4017807094978		1	E14	max. 60			A++ ... E	IP20	9321
476	5925011-07	4017807094985		1	E14	max. 60			A++ ... E	IP20	9321
476	5925011-08	4017807094992		1	E14	max. 60			A++ ... E	IP20	9321
476	5925011-24	4017807103694		1	E14	max. 60			A++ ... E	IP20	9394
477	5930011-01	4017807112788		1	E14	max. 40			A++ ... E	IP20	9395
477	5930011-24	4017807112801		1	E14	max. 40			A++ ... E	IP20	9396
158	593210106	4017807194876	✓	1	G9	28	370	2800K	C	IP20	92319
136	593900100	4017807224603		1	E14	max. 40			A++ ... E	IP20	92496
136	593900116	4017807224627		1	E14	max. 40			A++ ... E	IP20	92496-16
484	593900142	4017807224634		1	E14	max. 40			A++ ... E	IP20	92496-42
136	593900192	4017807224641		1	E14	max. 40			A++ ... E	IP20	92496-92
484	594010106	4017807208856	✓	1	G9	28	370	2800K	C	IP20	92390-06
484	594010192	4017807208894	✓	1	G9	28	370	2800K	C	IP20	92390-92
477	5949011-07	4017807148855		1	E14	max. 40			A++ ... E	IP20	9554
478	5950011-07	4017807111316		1	E14	max. 40			A++ ... E	IP20	9397-01
478	5950011-18	4017807129731		1	E14	max. 40			A++ ... E	IP20	9299-18
480	595500106	4017807154528		1	E14	max. 40			A++ ... E	IP20	9610-01
480	595500107	4017807154535		1	E14	max. 40			A++ ... E	IP20	9610-00
480	595500108	4017807156454		1	E14	max. 60			A++ ... E	IP20	9610-00
480	595500124	4017807154559		1	E14	max. 40			A++ ... E	IP20	9610-00
487	5960011-01	4017807149609		1	E14	max. 40			A++ ... E	IP20	92282
487	5960011-02	4017807149623		1	E14	max. 40			A++ ... E	IP20	
134	597800107	4017807189209		1	E14	max. 40			A++ ... E	IP20	92259-22
130	598210107	4017807236590	✓	1	G9	28	370	2800K	C	IP20	92542
130	598210124	4017807236606	✓	1	G9	28	370	2800K	C	IP20	92542



Seite Page	Artikel-Nr. Product No.	EAN-Nummer EAN-Number	incl. 	#	Sockel Fitting	Watt Watt	Lumen Lumen	Kelvin Kelvin	EEK (874/2012)	IP IP	Ersatzteile Spare parts
152	598400106	4017807240214		1	E14	max. 40			A++ ... E	IP20	
478	599000106	4017807195958		1	E14	max. 40			A++ ... E	IP20	92271-06
478	599000107	4017807195965		1	E14	max. 40			A++ ... E	IP20	92271-07
478	599000108	4017807195972		1	E14	max. 40			A++ ... E	IP20	92271-07
478	599000118	4017807195989		1	E14	max. 40			A++ ... E	IP20	92271-18
478	599000124	4017807195996		1	E14	max. 40			A++ ... E	IP20	92271-07
486	599600101	4017807256055		1	E14	max. 40			A++ ... E	IP20	
486	599600102	4017807257472		1	E14	max. 40			A++ ... E	IP20	
486	599600115	4017807256086		1	E14	max. 40			A++ ... E	IP20	
486	599600119	4017807257793		1	E14	max. 40			A++ ... E	IP20	
486	599600142	4017807256093		1	E14	max. 40			A++ ... E	IP20	
156	600400106	4017807220094		1	E27	max. 60			A++ ... E	IP20	
374	600900224	4017807211887		2	E27	max. 40			A++ ... E	IP20	92403
382	601100100	4017807218404		1	E14	max. 40			A++ ... E	IP20	92420 92420-01
382	601100200	4017807218411		2	E14	max. 40			A++ ... E	IP20	92415 92415-01
382	601400100	4017807195484		1	E27	max. 60			A++ ... E	IP20	92287-00
382	601400101	4017807195491		1	E27	max. 60			A++ ... E	IP20	92287-01
382	601400106	4017807224580		1	E27	max. 40			A++ ... E	IP20	92460
382	601400115	4017807195507		1	E27	max. 60			A++ ... E	IP20	92287-15
382	601400117	4017807195514		1	E27	max. 60			A++ ... E	IP20	92287-17
382	601400192	4017807195538		1	E27	max. 60			A++ ... E	IP20	92287-92
377	601900100	4017807223545		1	E27	max. 40			A++ ... E	IP20	92464
377	601900200	4017807223552		2	E27	max. 40			A++ ... E	IP20	92464-02
384	602100100	4017807223569		1	E27	max. 40			A++ ... E	IP20	92465
384	602100200	4017807223576		2	E27	max. 40			A++ ... E	IP20	92465-02
380	602400106	4017807244915		1	E27	max. 40			A++ ... E	IP20	92579-25
380	602400206	4017807244922		2	E27	max. 40			A++ ... E	IP20	92579-30
377	602600200	4017807224528		2	E14	max. 40			A++ ... E	IP20	92456
377	602700200	4017807224535		2	E27	max. 60			A++ ... E	IP20	92457
376	603100100	4017807232059		1	E27	max. 40			A++ ... E	IP20	92486-30
376	603100200	4017807232066		2	E27	max. 40			A++ ... E	IP20	92486-40
372	603800201	4017807293845		2	E14	max. 60			A++ ... E	IP20	
372	603800214	4017807294071		2	E14	max. 60			A++ ... E	IP20	
372	603800287	4017807294088		2	E14	max. 60			A++ ... E	IP20	
372	603800401	4017807294095		4	E27	max. 60			A++ ... E	IP20	
372	603800414	4017807294101		4	E27	max. 60			A++ ... E	IP20	
372	603800487	4017807294118		4	E27	max. 60			A++ ... E	IP20	
142	603900201	4017807289688		2	E14	max. 40			A++ ... E	IP20	
142	603900202	4017807289695		2	E14	max. 40			A++ ... E	IP20	
142	603900214	4017807289701		2	E14	max. 40			A++ ... E	IP20	
142	603900301	4017807256536		3	E27	max. 60			A++ ... E	IP20	92662
142	603900302	4017807256543		3	E27	max. 60			A++ ... E	IP20	92662-02
142	603900314	4017807256550		3	E27	max. 60			A++ ... E	IP20	92662-14
383	604000106	4017807295689		1	E27	max. 40			A++ ... E	IP20	92769-25
383	604000206	4017807295696		2	E27	max. 40			A++ ... E	IP20	92769-30
381	604200106	4017807293852		1	E27	max. 40			A++ ... E	IP20	92776
381	604200206	4017807293869		2	E27	max. 40			A++ ... E	IP20	92776-01
370	605600307	4017807236996		3	E14	max. 40			A++ ... E	IP20	92529
370	605600507	4017807237009		5	E14	max. 40			A++ ... E	IP20	92529
134	607800100	4017807189216		1	E27	max. 60			A++ ... E	IP20	92259-30
375	608100224	4017807211795		2	E27	max. 42			A++ ... E	IP20	92472-01
375	608100324	4017807211788		3	E27	max. 60			A++ ... E	IP20	92472
371	609000306	4017807174021		3	E14	max. 40			A++ ... E	IP20	9703

Seite Page	Artikel-Nr. Product No.	EAN-Nummer EAN-Number	incl. 	#	Socket Fitting	Watt Watt	Lumen Lumen	Kelvin Kelvin	EEK (874/2012)	IP IP	Ersatzteile Spare parts
381	609200406	4017807179019		4	E14	max. 40			A++ ... E	IP20	92224
157	609700306	4017807196481		3	E14	max. 40			A++ ... E	IP20	92324
385	6101011-01	4017807017557		1	E27	max. 60			A++ ... E	IP20	9218-01
385	6101011-06	4017807028386		1	E27	max. 60			A++ ... E	IP20	9218-01
385	6101011-07	4017807028393		1	E27	max. 60			A++ ... E	IP20	9218-01
129	6102021-24	4017807053296		2	E27	max. 60			A++ ... E	IP20	92126
378	6105011-01	4017807053968		1	E27	max. 40			A++ ... E	IP20	9285-01
378	6105011-24	4017807098716		1	E27	max. 40			A++ ... E	IP20	9285-24
378	6105021-01	4017807098440		2	E27	max. 40			A++ ... E	IP20	9287-01
378	6105021-24	4017807100587		2	E27	max. 40			A++ ... E	IP20	9287-24
379	6107011-07	4017807028041		1	E27	max. 60			A++ ... E	IP20	9231
379	6107021-07	4017807080704		2	E27	max. 60			A++ ... E	IP20	92151
158	613210506	4017807187243	✓	5	G9	28	370	2800K	C	IP20	92319
379	6151011-01	4017807131994		1	E27	max. 60			A++ ... E	IP20	9512
379	6151021-01	4017807132014		2	E27	max. 60			A++ ... E	IP20	9513
385	6160011-00	4017807131895		1	E27	max. 60			A++ ... E	IP20	9516
384	6196011-01	4017807138238		1	E27	max. 40			A++ ... E	IP20	9523-01
384	6196011-07	4017807138245		1	E27	max. 40			A++ ... E	IP20	9523-07
312	620711405	4017807245103	✓	14	SMD-LED	1,1	115	3000K	A++	IP20	92573
346	620912505	4017807279702	✓	1	SMD-LED	25	2100	3000 - 5500K	A	IP20	
246	621410505	4017807220940	✓	5	SMD-LED	4,5	400	3000K	A+	IP20	92426
327	621512406	4017807293944	✓	1	SMD-LED	10	900	3000K	A+	IP20	
			✓	5	SMD-LED	2,8	340	3000K	A++		
327	621513506	4017807293951	✓	1	SMD-LED	12,5	1250	3000K	A	IP20	
			✓	5	SMD-LED	4,5	450	3000K	A+		
323	622310506	4017807236354	✓	1	COB-LED	5	400	3500K	A	IP20	92535-17 92535-20 92535-24
323	622311206	4017807239355	✓	1	SMD-LED	12	1200	3500K	A	IP20	92536-35 92536-30 92536-25
339	622713007	4017807226812	✓	1	SMD-LED	12	1100	3500K	A+	IP44	
339	622714007	4017807226805	✓	1	SMD-LED	18	1600	3500K	A+	IP44	
339	622716007	4017807226850	✓	1	SMD-LED	40	3000	3500K	A	IP20	
339	C622716007	4017807336474	✓	1	SMD-LED	40	3000	3500K	A	IP20	
314	622811527	4017807262391	✓	15	SMD-LED	1	90	3000K	A++	IP20	92686
314	622811528	4017807262407	✓	15	SMD-LED	1,1	115	3000K	A++	IP20	92686
309	623311806	4017807196252	✓	18	SMD-LED	1,1	115	3000K	A++	IP20	92260
			✓	2	SMD-LED	4,5	400	3000K	A+		94461
352	623510407	4017807268119	✓	4	SMD-LED	4,5	400	3000K	A+	IP20	92687-01
352	623510428	4017807268126	✓	4	SMD-LED	4,5	400	3000K	A+	IP20	92687-01
322	623810306	4017807261295	✓	3	SMD-LED	4,5	400	3000K	A+	IP20	92691-03
322	623810406	4017807261301	✓	4	SMD-LED	4,5	400	3000K	A+	IP20	92691-04
322	623810506	4017807261318	✓	5	SMD-LED	4,5	400	3000K	A+	IP20	92691-05
361	624011206	4017807245141	✓	1	SMD-LED	12	1050	3000K	A+	IP20	
361	624012306	4017807245905	✓	1	SMD-LED	25	2000	3000K	A	IP20	
292	624830307	4017807257724	✓	3	E14	4	320	3000K	A+	IP20	98249
292	624830328	4017807257892	✓	3	E14	4	320	3000K	A+	IP20	98249
48	625110505	4017807329216	✓	5	SMD-LED	3	230	3000K	A+	IP20	
48	625110605	4017807329223	✓	6	SMD-LED	3	230	3000K	A+	IP20	
360	625211007	4017807229318	✓	3	SMD-LED	4,5	400	3000K	A+	IP20	92508
360	625211008	4017807273274	✓	3	SMD-LED	4,5	400	3000K	A+	IP20	92508
360	625211807	4017807229325	✓	5	SMD-LED	4,5	400	3000K	A+	IP20	92508-41
360	625211808	4017807273281	✓	5	SMD-LED	4,5	400	3000K	A+	IP20	92508-41

Seite Page	Artikel-Nr. Product No.	EAN-Nummer EAN-Number	incl. 	#	Socket Fitting	Watt Watt	Lumen Lumen	Kelvin Kelvin	EEK (874/2012)	IP IP	Ersatzteile Spare parts
353	625511006	4017807229370	✓	1	SMD-LED	10	980	3100K	A	IP20	92510 92510-02
353	625511806	4017807229387	✓	1	SMD-LED	18	1750	3000K	A	IP20	92510-01 92510-03
350	625911205	4017807245165	✓	1	SMD-LED	12	1050	3000K	A+	IP20	
350	625912305	4017807245912	✓	1	SMD-LED	23	2000	3000K	A	IP20	
363	626510901	4017807245196	✓	1	SMD-LED	9	750	3000K	A+	IP20	
363	626510987	4017807245202	✓	1	SMD-LED	9	750	3000K	A+	IP20	
363	626511201	4017807245219	✓	1	SMD-LED	12	1050	3000K	A+	IP20	
363	626511287	4017807245226	✓	1	SMD-LED	12	1050	3000K	A+	IP20	
363	626512501	4017807246797	✓	1	SMD-LED	25	2000	3000K	A	IP20	
363	626512587	4017807246803	✓	1	SMD-LED	25	2000	3000K	A	IP20	
362	627111001	4017807267389	✓	1	SMD-LED	10	730	3000K	A	IP20	
362	627111087	4017807267396	✓	1	SMD-LED	10	730	3000K	A	IP20	
362	627111501	4017807267402	✓	1	SMD-LED	15	1100	3000K	A	IP20	
362	627111587	4017807267419	✓	1	SMD-LED	15	1100	3000K	A	IP20	
362	627211001	4017807267426	✓	1	SMD-LED	10	730	3000K	A	IP20	
362	627211087	4017807267433	✓	1	SMD-LED	10	730	3000K	A	IP20	
362	627211501	4017807267440	✓	1	SMD-LED	15	1100	3000K	A	IP20	
362	627211587	4017807267457	✓	1	SMD-LED	15	1100	3000K	A	IP20	
328	627910406	4017807261691	✓	4	SMD-LED	4,5	400	3000K	A+	IP20	92689-26
328	627910506	4017807263961	✓	5	SMD-LED	4,5	400	3000K	A+	IP20	92689-38
328	627910906	4017807261707	✓	9	SMD-LED	4,5	400	3000K	A+	IP20	92689-30
328	C627910906	4017807294552	✓	9	SMD-LED	4,5	400	3000K	A+	IP20	92689-30
333	628010506	4017807271102	✓	5	SMD-LED	4,5	400	3000K	A+	IP20	92709
282	628290501	4017807259827	✓	5	SMD-LED	3,8	350	3100K	A+	IP20	
280	628290506	4017807259834	✓	5	SMD-LED	3,8	350	3100K	A+	IP20	
308	628412107	4017807256529	✓	21	SMD-LED	1,1	115	3000K	A++	IP20	92661
348	628513001	4017807298819	✓	1	SMD-LED	30	2400	3000 - 5500K	A	IP20	
334	628611206	4017807245837	✓	1	SMD-LED	12	960	3000K	A	IP20	92572-29 92572-18
334	628611806	4017807245844	✓	1	SMD-LED	18	1400	3000K	A	IP20	92572-38 92572-26
347	628613001	4017807298826	✓	1	SMD-LED	30	2400	3000 - 5500K	A	IP20	
347	628715001	4017807296907	✓	1	SMD-LED	50	4800	3000 - 6500K	A+	IP20	
344	628815001	4017807279696	✓	1	SMD-LED	50	4000	3000 - 5500K	A	IP20	
330	628910306	4017807255850	✓	3	SMD-LED	4,5	400	3000K	A+	IP20	92639
330	628910406	4017807255867	✓	4	SMD-LED	4,5	400	3000K	A+	IP20	92639-01
345	628915001	4017807272307	✓	1	SMD-LED	50	4000	3000 - 5500K	A	IP20	
367	629110106	4017807325249	✓	1	SMD-LED	10	800	3000K	A+	IP20	92783
284	629410507	4017807264906	✓	5	SMD-LED	4,5	400	3000K	A+	IP20	92668
496	629510101	4017807256819	✓	1	SMD-LED	5,5	380	3000K	A+	IP65	
496	629510105	4017807256826	✓	1	SMD-LED	5,5	380	3000K	A+	IP65	
122	629710306	4017807242577	✓	3	SMD-LED	5	400	3000K	A	IP20	92566
122	629710506	4017807242584	✓	5	SMD-LED	5	400	3000K	A	IP20	92566
509	6309051-07	4017807107937		5	E14	max. 40			A++ ... E	IP21	9425
368	6380031-07	4017807115215	✓	3	G9	28	370	2800K	C	IP20	9460
368	6380031-08	4017807150360	✓	3	G9	28	370	2800K	C	IP20	9460
368	6380031-24	4017807231182	✓	3	G9	28	370	2800K	C	IP20	9460-24
368	6380051-07	4017807150124	✓	5	G9	28	370	2800K	C	IP20	9460
368	6380051-08	4017807150353	✓	5	G9	28	370	2800K	C	IP20	9460
368	6380051-24	4017807231199	✓	5	G9	28	370	2800K	C	IP20	9460-24
368	638090607	4017807207644	✓	6	G9	28	370	2800K	C	IP20	92357 92357-01

Seite Page	Artikel-Nr. Product No.	EAN-Nummer EAN-Number	incl. 	#	Socket Fitting	Watt Watt	Lumen Lumen	Kelvin Kelvin	EEK (874/2012)	IP IP	Ersatzteile Spare parts
368	638090624	4017807207651	✓	6	G9	28	370	2800K	C	IP20	92357 92357-01
321	656612001	4017807286281	✓	1	SMD-LED	20	1720	3000K	A	IP20	92731-20
321	656613001	4017807286298	✓	1	SMD-LED	30	2580	3000K	A	IP20	92731-30
320	656712001	4017807286304	✓	1	SMD-LED	20	1720	3000K	A	IP20	92732-20
320	656713001	4017807286311	✓	1	SMD-LED	30	2580	3000K	A	IP20	92732-30
43	656812079	4017807284188	✓	1	SMD-LED	20	1720	3000K	A	IP20	92724-79
43	656812089	4017807284195	✓	1	SMD-LED	20	1720	3000K	A	IP20	92724-89
43	656813079	4017807284201	✓	1	SMD-LED	30	2580	3000K	A	IP20	92725-79
43	656813089	4017807284218	✓	1	SMD-LED	30	2580	3000K	A	IP20	92725-79
365	657010601	4017807294637	✓	1	SMD-LED	5	700	3000K	A++	IP20	
365	657010607	4017807294675	✓	1	SMD-LED	5	700	3000K	A++	IP20	
365	657011201	4017807294712	✓	1	SMD-LED	11	1300	3000K	A+	IP20	
365	657011207	4017807294729	✓	1	SMD-LED	11	1300	3000K	A+	IP20	
365	657011801	4017807294743	✓	1	SMD-LED	16,5	2000	3000K	A+	IP20	
365	657011807	4017807294750	✓	1	SMD-LED	16,5	2000	3000K	A+	IP20	
364	657110601	4017807294651	✓	1	SMD-LED	5	700	3000K	A++	IP20	
364	657110607	4017807294668	✓	1	SMD-LED	5	700	3000K	A++	IP20	
364	657111201	4017807294705	✓	1	SMD-LED	11	1300	3000K	A+	IP20	
364	657111207	4017807294699	✓	1	SMD-LED	11	1300	3000K	A+	IP20	
364	657111801	4017807294767	✓	1	SMD-LED	16,5	2000	3000K	A+	IP20	
364	657111807	4017807294774	✓	1	SMD-LED	16,5	2000	3000K	A+	IP20	
326	657211206	4017807299007	✓	1	SMD-LED	12	900	3000K	A	IP20	92778 92778-18
326	657211806	4017807299014	✓	1	SMD-LED	18	1350	3000K	A	IP20	92778 92778-18 92778-24
326	657311206	4017807299021	✓	1	SMD-LED	12	900	3000K	A	IP20	92778 92778-18
326	657311806	4017807299038	✓	1	SMD-LED	18	1350	3000K	A	IP20	92778 92778-18 92778-24
356	658311401	4017807300932	✓	1	SMD-LED	11	1000	3000K	A+	IP20	
356	658312601	4017807300949	✓	1	SMD-LED	21	2000	3000K	A+	IP20	
354	658412601	4017807300895	✓	1	SMD-LED	21	2000	3000K	A+	IP20	
355	658512601	4017807300901	✓	1	SMD-LED	21	2000	3000K	A+	IP20	
357	658611407	4017807300918	✓	1	SMD-LED	11	1000	3000K	A+	IP20	
357	658612607	4017807300925	✓	1	SMD-LED	21	2000	3000K	A+	IP20	
342	658714001	4017807302349	✓	1	SMD-LED	40	3600	3000 - 5500K	A+	IP20	
342	658715801	4017807294859	✓	1	SMD-LED	58	4800	3000 - 5500K	A	IP20	
346	658811505	4017807286441	✓	1	SMD-LED	11	1100	3000K	A+	IP20	
			✓	1	SMD-LED	4	100	RGB			
346	658813005	4017807286458	✓	1	SMD-LED	23	2300	3000K	A+	IP20	
			✓	1	SMD-LED	7	200	RGB			
504	659011801	4017807280081	✓	1	SMD-LED	18	1600	3000K	A+	IP44	
504	659011887	4017807280098	✓	1	SMD-LED	18	1600	3000K	A+	IP44	
359	659112406	4017807282733	✓	1	SMD-LED	24	2100	3000K	A	IP20	
505	659411806	4017807280050	✓	1	SMD-LED	18	1600	3000K	A+	IP44	
505	659412406	4017807280074	✓	1	SMD-LED	24	2100	3000K	A	IP44	
351	659511605	4017807267211	✓	1	SMD-LED	16	1450	3000K	A	IP20	
351	659512405	4017807267228	✓	1	SMD-LED	24	2000	3000K	A	IP20	
351	659513605	4017807267235	✓	1	SMD-LED	30	3000	3000K	A+	IP20	
367	659611006	4017807267174	✓	1	SMD-LED	10	850	3000K	A	IP20	92678-25
367	659611506	4017807267181	✓	1	SMD-LED	15	1200	3000K	A	IP20	92678-33
367	659612006	4017807267198	✓	1	SMD-LED	18	1600	3000K	A	IP20	92678-40



Seite Page	Artikel-Nr. Product No.	EAN-Nummer EAN-Number	incl. 	#	Socket Fitting	Watt Watt	Lumen Lumen	Kelvin Kelvin	EEK (874/2012)	IP IP	Ersatzteile Spare parts
154	661300505	4017807209341		5	E14	max. 40			A++ ... E	IP20	
98	670610407	4017807299663	✓	4	SMD-LED	4,5	430	3000K	A+	IP20	
98	670610607	4017807299670	✓	6	SMD-LED	4,5	430	3000K	A+	IP20	
294	671410507	4017807261882	✓	5	E14	4	320	3000K	A+	IP20	92680
286	671510507	4017807285000	✓	5	G9	3,5	300	3000K	A+	IP20	92739
94	671810305	4017807294057	✓	3	SMD-LED	6	640	3000K	A+	IP20	
242	671930406	4017807294262	✓	4	SMD-LED	4,3	400	3000K	A+	IP20	
80	672010506	4017807294170	✓	5	SMD-LED	4,3	400	3000K	A+	IP20	
72	672212405	4017807297553	✓	1	SMD-LED	24	2400	3000K	A+	IP20	
72	C672212405	4017807336344	✓	1	SMD-LED	24	2400	3000K	A+	IP20	
278	672810501	4017807262360	✓	5	SMD-LED	3,8	350	3100K	A+	IP20	
276	672810506	4017807262377	✓	5	SMD-LED	3,8	350	3100K	A+	IP20	
60	672910106	4017807299274	✓	1	SMD-LED	20	1800	3000K	A+	IP20	
60	C672910106	4017807336511	✓	1	SMD-LED	20	1800	3000K	A+	IP20	
70	673110806	4017807281101	✓	8	SMD-LED	3,2	300	3000K	A+	IP20	
70	C673110806	4017807287318	✓	8	SMD-LED	3,2	300	3000K	A+	IP20	
70	673111206	4017807281118	✓	12	SMD-LED	3,2	300	3000K	A+	IP20	
70	C673111206	4017807287325	✓	12	SMD-LED	3,2	300	3000K	A+	IP20	
274	674210506	4017807293562	✓	5	SMD-LED	3,5	370	3000K	A++	IP20	
88	674312406	4017807285925	✓	1	SMD-LED	24	2160	3000K	A+	IP20	
248	674410506	4017807267327	✓	5	SMD-LED	4,5	400	3000K	A+	IP20	
106	674910106	4017807306002	✓	1	SMD-LED	30	2500	3000/4500/6500K	A	IP20	
62	675210406	4017807295740	✓	4	SMD-LED	4,5	430	3000K	A+	IP20	
62	675210506	4017807295757	✓	5	SMD-LED	4,5	430	3000K	A+	IP20	
62	C675210506	4017807336498	✓	5	SMD-LED	4,5	430	3000K	A+	IP20	
324	675410107	4017807299601	✓	1	SMD-LED	22,5	2000	3000K	A+	IP20	
324	C675410107	4017807336306	✓	1	SMD-LED	22,5	2000	3000K	A+	IP20	
324	675410407	4017807299618	✓	4	SMD-LED	4,3	390	3000K	A+	IP20	
324	C675410407	4017807336313	✓	4	SMD-LED	4,3	390	3000K	A+	IP20	
313	675510207	4017807299441	✓	1	SMD-LED	26	2700	3000K	A+	IP20	
313	C675510207	4017807336320	✓	1	SMD-LED	26	2700	3000K	A+	IP20	
337	675710507	4017807292695	✓	5	SMD-LED	4,5	340	3000K	A+	IP20	
266	675810406	4017807299373	✓	4	SMD-LED	3,8	330	3000K	A+	IP20	
266	675810906	4017807299380	✓	9	SMD-LED	3,8	330	3000K	A+	IP20	
102	675910506	4017807285987	✓	5	SMD-LED	3,8	350	3000K	A+	IP20	
102	675990606	4017807286014	✓	6	SMD-LED	3,8	350	3000/4000/5000K	A+	IP20	
102	675990906	4017807286021	✓	9	SMD-LED	3,8	350	3000/4000/5000K	A+	IP20	
56	676310206	4017807298925	✓	4	SMD-LED	7	700	3000K	A+	IP20	
58	676310806	4017807302769	✓	4	SMD-LED	4,1	410	3000K	A+	IP20	
			✓	4	SMD-LED	2,8	280	3000K	A+		
104	676412406	4017807287264	✓	1	SMD-LED	24	2200	3000K	A	IP20	
104	676413606	4017807281620	✓	1	SMD-LED	32	3000	3000K	A+	IP20	
112	676510302	4017807285765	✓	3	SMD-LED	4,5	430	3000K	A+	IP20	
112	676510306	4017807285772	✓	3	SMD-LED	4,5	430	3000K	A+	IP20	
107	676712406	4017807305807	✓	1	SMD-LED	20	1800	3000K	A+	IP20	
64	676810307	4017807299069	✓	3	SMD-LED	5	550	3000K	A++	IP20	
64	676810507	4017807299076	✓	5	SMD-LED	5	550	3000K	A++	IP20	
366	677111001	4017807274400	✓	1	SMD-LED	10	800	3000K	A+	IP20	92708-01
366	677111087	4017807274417	✓	1	SMD-LED	10	800	3000K	A+	IP20	92708-01
366	677211001	4017807274424	✓	1	SMD-LED	10	800	3000K	A+	IP20	92708
366	677211006	4017807274448	✓	1	SMD-LED	10	800	3000K	A+	IP20	92708
366	677211087	4017807274431	✓	1	SMD-LED	10	800	3000K	A+	IP20	92708
86	677610606	4017807274561	✓	6	SMD-LED	5	500	3000K	A+	IP20	
86	C677610606	4017807336467	✓	6	SMD-LED	5	500	3000K	A+	IP20	
84	678210407	4017807302813	✓	4	SMD-LED	4,5	380	3000K	A+	IP20	

Seite Page	Artikel-Nr. Product No.	EAN-Nummer EAN-Number	incl. 	#	Socket Fitting	Watt Watt	Lumen Lumen	Kelvin Kelvin	EEK (874/2012)	IP IP	Ersatzteile Spare parts
50	678310607	4017807303100	✓	6	SMD-LED	3,2	300	3000K	A+	IP20	
50	C678310607	4017807336443	✓	6	SMD-LED	3,2	300	3000K	A+	IP20	
52	678410807	4017807281323	✓	8	SMD-LED	4,5	430	3000K	A+	IP20	
52	C678410807	4017807295382	✓	8	SMD-LED	4,5	430	3000K	A+	IP20	
310	678510906	4017807273915	✓	9	SMD-LED	3,2	300	3000K	A+	IP20	
310	C678510906	4017807287363	✓	9	SMD-LED	3,2	300	3000K	A+	IP20	
262	678610506	4017807282047	✓	5	SMD-LED	4,5	430	3000K	A+	IP20	92766
262	C678610506	4017807294538	✓	5	SMD-LED	4,5	430	3000K	A+	IP20	92766
358	678811801	4017807273717	✓	4	SMD-LED	4,5	400	3000K	A+	IP20	
358	678811815	4017807273731	✓	4	SMD-LED	4,5	400	3000K	A+	IP20	
358	678811842	4017807273748	✓	4	SMD-LED	4,5	400	3000K	A+	IP20	
358	678811887	4017807273755	✓	4	SMD-LED	4,5	400	3000K	A+	IP20	
329	679010407	4017807281156	✓	4	SMD-LED	4,5	430	3000K	A+	IP20	
68	679411805	4017807256307	✓	1	SMD-LED	18	1800	3000K	A+	IP20	
340	679612006	4017807294910	✓	1	SMD-LED	20	1900	3000K	A+	IP20	
340	C679612006	4017807295900	✓	1	SMD-LED	20	1900	3000K	A+	IP20	
340	679612007	4017807286885	✓	1	SMD-LED	20	1900	3000K	A+	IP20	
340	C679612007	4017807295917	✓	1	SMD-LED	20	1900	3000K	A+	IP20	
340	679612008	4017807294927	✓	1	SMD-LED	20	1900	3000K	A+	IP20	
340	C679612008	4017807295924	✓	1	SMD-LED	20	1900	3000K	A+	IP20	
340	679612028	4017807294934	✓	1	SMD-LED	20	1900	3000K	A+	IP20	
340	C679612028	4017807295931	✓	1	SMD-LED	20	1900	3000K	A+	IP20	
76	679612807	4017807286977	✓	3	SMD-LED	10	900	3000K	A+	IP20	
76	C679612807	4017807295887	✓	3	SMD-LED	10	900	3000K	A+	IP20	
508	6800011-01	4017807147551		1	E27	max. 60			A++ ... E	IP21	9582
508	6800021-01	4017807147568		2	E27	max. 60			A++ ... E	IP21	9581
508	6801011-01	4017807259056		1	E27	max. 60			A++ ... E	IP44	
508	6801011-06	4017807147575		1	E27	max. 60			A++ ... E	IP44	9580
508	6801011-07	4017807147582		1	E27	max. 60			A++ ... E	IP44	9580
503	680511806	4017807246032	✓	1	SMD-LED	18	1400	3500K	A	IP44	92598
503	680611206	4017807246056	✓	4	SMD-LED	4,5	400	3000K	A+	IP44	92599
503	680711206	4017807246049	✓	1	SMD-LED	12	840	3500K	A	IP44	92600
498	681910406	4017807244854	✓	4	SMD-LED	4,5	400	3000K	A+	IP44	92651
497	682310306	4017807286274	✓	3	SMD-LED	3,2	300	3000K	A+	IP44	92736
493	682410506	4017807280845	✓	5	SMD-LED	3,2	300	3000K	A+	IP44	
273	770010587	4017807287196	✓	5	GU5.3	3	260	3000K	A+	IP20	92755
273	774110506	4017807287172	✓	5	SMD-LED	3,8	350	3000K	A+	IP20	92757
270	775810506	4017807305043	✓	5	SMD-LED	4,1	330	3000K	A+	IP20	
270	775910506	4017807285994	✓	5	SMD-LED	3,8	350	3000K	A+	IP20	92758
272	777710506	4017807305050	✓	5	SMD-LED	4,1	330	3000K	A+	IP20	
273	778210506	4017807281576	✓	5	SMD-LED	3,8	350	3100K	A+	IP20	92756
305	801000106	4017807231632		1	E14	max. 40			A++ ... E	IP20	92505
305	801000206	4017807231649		2	E14	max. 40			A++ ... E	IP20	92505
305	801000306	4017807231656		3	E14	max. 40			A++ ... E	IP20	92505
305	801000406	4017807231663		4	E14	max. 40			A++ ... E	IP20	92505
305	801000606	4017807231670		6	E14	max. 40			A++ ... E	IP20	92505
302	802400101	4017807227543		1	GU10	max. 35			A++ ... E	IP20	
302	802400107	4017807231335		1	GU10	max. 35			A++ ... E	IP20	
302	802400201	4017807227550		2	GU10	max. 35			A++ ... E	IP20	
302	802400207	4017807231359		2	GU10	max. 35			A++ ... E	IP20	
302	802400301	4017807227567		3	GU10	max. 35			A++ ... E	IP20	
302	802400307	4017807231373		3	GU10	max. 35			A++ ... E	IP20	
302	802430401	4017807227574		4	GU10	max. 35			A++ ... E	IP20	
302	802430407	4017807231397		4	GU10	max. 35			A++ ... E	IP20	
180	802500178	4017807299519		1	GU10	max. 42			A++ ... E	IP20	

Seite Page	Artikel-Nr. Product No.	EAN-Nummer EAN-Number	incl. 	#	Socket Fitting	Watt Watt	Lumen Lumen	Kelvin Kelvin	EEK (874/2012)	IP IP	Ersatzteile Spare parts
180	802500278	4017807299526		2	GU10	max. 42			A++ ... E	IP20	
180	802500378	4017807299540		3	GU10	max. 42			A++ ... E	IP20	
300	8130011-07	4017807123630	✓	1	GU10	50	310	2800K	D	IP20	
300	8130021-07	4017807123654	✓	2	GU10	50	310	2800K	D	IP20	
300	8130031-07	4017807123661	✓	3	GU10	50	310	2800K	D	IP20	
300	8130061-07	4017807123692	✓	6	GU10	50	310	2800K	D	IP20	
300	8130441-07	4017807123685	✓	4	GU10	50	310	2800K	D	IP20	
300	8130911-07	4017807123647	✓	1	GU10	35	240	2800K	D	IP20	
300	8130931-07	4017807123678	✓	3	GU10	50	310	2800K	D	IP20	
296	8160031-07	4017807115802	✓	3	G9	28	370	2800K	C	IP20	9461
296	8160211-07	4017807115772	✓	1	G9	28	370	2800K	C	IP20	9461
296	8160221-07	4017807115796	✓	2	G9	28	370	2800K	C	IP20	9461
296	8160911-07	4017807115789	✓	1	G9	28	370	2800K	C	IP20	9461
298	8161011-07	4017807135589	✓	1	G9	28	370	2800K	C	IP20	9325
298	8161021-07	4017807135602	✓	2	G9	28	370	2800K	C	IP20	9325
298	8161031-07	4017807135626	✓	3	G9	28	370	2800K	C	IP20	9325
298	8161061-07	4017807134209	✓	6	G9	28	370	2800K	C	IP20	9325
298	8161441-07	4017807134216	✓	4	G9	28	370	2800K	C	IP20	9325
298	8161911-07	4017807135671	✓	1	G9	18	204	2800K	C	IP20	9325
298	8161931-07	4017807134223	✓	3	G9	28	370	2800K	C	IP20	9325
304	818000206	4017807203059		2	GU10	max. 25			A++ ... E	IP20	
304	818000306	4017807203066		3	GU10	max. 25			A++ ... E	IP20	
304	818000406	4017807203073		4	GU10	max. 25			A++ ... E	IP20	
304	818000606	4017807203080		6	GU10	max. 25			A++ ... E	IP20	
304	818070106	4017807203042		1	GU10	max. 25			A++ ... E	IP20	
246	821410305	4017807220902	✓	3	SMD-LED	4,5	400	3000K	A+	IP20	92426
246	821410405	4017807220919	✓	4	SMD-LED	4,5	400	3000K	A+	IP20	92426
246	821410605	4017807220933	✓	6	SMD-LED	4,5	400	3000K	A+	IP20	92426
246	821430405	4017807220926	✓	4	SMD-LED	4,5	400	3000K	A+	IP20	92426
246	821470105	4017807220889	✓	1	SMD-LED	4,5	400	3000K	A+	IP20	92426
246	821470205	4017807220896	✓	2	SMD-LED	4,5	400	3000K	A+	IP20	92426
264	821710406	4017807302943	✓	3	SMD-LED	4	310	3000K	A+	IP20	
			✓	1	SMD-LED	6	500	3000K	A+		
264	821710606	4017807302950	✓	4	SMD-LED	4	310	3000K	A+	IP20	
			✓	2	SMD-LED	5,5	430	3000K	A+		
264	821770206	4017807302929	✓	1	SMD-LED	4	310	3000K	A+	IP20	
			✓	1	SMD-LED	4	310	3000K	A+		
264	821770306	4017807302967	✓	2	SMD-LED	4	310	3000K	A+	IP20	
			✓	1	SMD-LED	5,5	430	3000K	A+		
297	821910207	4017807221268	✓	2	G9	28	370	2800K	C	IP20	92411
			✓	13	DIP	0,06	8	4100K	A		
297	821910307	4017807221275	✓	3	G9	28	370	2800K	C	IP20	92411
			✓	20	DIP	0,06	8	4100K	A		
297	821910407	4017807217803	✓	4	G9	28	370	2800K	C	IP20	92411
			✓	27	DIP	0,06	8	4100K	A		
297	821970107	4017807221503	✓	1	G9	28	370	2800K	C	IP20	92411
			✓	8	DIP	0,06	8	4100K	A		
292	824810107	4017807257526	✓	1	E14	4	320	3000K	A+	IP20	98249
292	824810128	4017807257809	✓	1	E14	4	320	3000K	A+	IP20	98249
292	824810207	4017807257540	✓	2	E14	4	320	3000K	A+	IP20	98249
292	824810228	4017807257816	✓	2	E14	4	320	3000K	A+	IP20	98249
292	824810307	4017807257564	✓	3	E14	4	320	3000K	A+	IP20	98249
292	824810328	4017807257823	✓	3	E14	4	320	3000K	A+	IP20	98249
292	824810407	4017807257588	✓	4	E14	4	320	3000K	A+	IP20	98249
292	824810428	4017807257830	✓	4	E14	4	320	3000K	A+	IP20	98249

Seite Page	Artikel-Nr. Product No.	EAN-Nummer EAN-Number	incl. 	#	Socket Fitting	Watt Watt	Lumen Lumen	Kelvin Kelvin	EEK (874/2012)	IP IP	Ersatzteile Spare parts
292	824810607	4017807257601	✓	6	E14	4	320	3000K	A+	IP20	98249
292	824810628	4017807257847	✓	6	E14	4	320	3000K	A+	IP20	98249
282	828210101	4017807236712	✓	1	SMD-LED	3,8	350	3100K	A+	IP20	
280	828210106	4017807236767	✓	1	SMD-LED	3,8	350	3100K	A+	IP20	
282	828210201	4017807236729	✓	2	SMD-LED	3,8	350	3100K	A+	IP20	
280	828210206	4017807236774	✓	2	SMD-LED	3,8	350	3100K	A+	IP20	
280	828210306	4017807236781	✓	3	SMD-LED	3,8	350	3100K	A+	IP20	
282	828210401	4017807236743	✓	4	SMD-LED	3,8	350	3100K	A+	IP20	
280	828210406	4017807236798	✓	4	SMD-LED	3,8	350	3100K	A+	IP20	
282	828210601	4017807236750	✓	6	SMD-LED	3,8	350	3100K	A+	IP20	
280	828210606	4017807236804	✓	6	SMD-LED	3,8	350	3100K	A+	IP20	
282	828230301	4017807236736	✓	3	SMD-LED	3,8	350	3100K	A+	IP20	
280	828280106	4017807240542	✓	1	SMD-LED	3,8	350	3100K	A+	IP20	
252	829210201	4017807256888	✓	2	SMD-LED	4,5	430	3000K	A+	IP20	
252	829210207	4017807256925	✓	2	COB-LED	5	345	3000K	A+	IP20	
252	829210301	4017807256895	✓	3	SMD-LED	4,5	430	3000K	A+	IP20	
252	829210307	4017807256932	✓	3	COB-LED	5	345	3000K	A+	IP20	
252	829210401	4017807260496	✓	4	SMD-LED	4,5	430	3000K	A+	IP20	
252	829210407	4017807260502	✓	4	COB-LED	5	345	3000K	A+	IP20	
252	829230401	4017807256901	✓	4	SMD-LED	4,5	430	3000K	A+	IP23	
252	829230407	4017807256949	✓	4	COB-LED	5	345	3000K	A+	IP20	
252	829270101	4017807256871	✓	1	SMD-LED	4,5	430	3000K	A+	IP20	
252	829270107	4017807256918	✓	1	SMD-LED	4,5	430	3000K	A+	IP20	
258	829310305	4017807248654	✓	3	SMD-LED	3,6	350	3000K	A+	IP20	
258	829310405	4017807248661	✓	4	SMD-LED	3,6	350	3000K	A+	IP20	
258	829310605	4017807248678	✓	6	SMD-LED	3,6	350	3000K	A+	IP20	
258	829370105	4017807248630	✓	1	SMD-LED	3,6	350	3000K	A+	IP20	
258	829370205	4017807248647	✓	2	SMD-LED	3,6	350	3000K	A+	IP20	
284	829410107	4017807256178	✓	1	SMD-LED	4,5	400	3000K	A+	IP20	92668
284	829410207	4017807256185	✓	2	SMD-LED	4,5	400	3000K	A+	IP20	92668
284	829410307	4017807256192	✓	3	SMD-LED	4,5	400	3000K	A+	IP20	92668
284	829410407	4017807256208	✓	4	SMD-LED	4,5	400	3000K	A+	IP20	92668
284	829410607	4017807256215	✓	6	SMD-LED	4,5	400	3000K	A+	IP20	92668
250	829910107	4017807302721	✓	1	SMD-LED	6	470	3000K	A	IP20	
250	C829910107	4017807336399	✓	1	SMD-LED	6	470	3000K	A	IP20	
250	829910207	4017807302738	✓	2	SMD-LED	6	470	3000K	A	IP20	
250	C829910207	4017807336405	✓	2	SMD-LED	6	470	3000K	A	IP20	
250	829910307	4017807302745	✓	3	SMD-LED	6	470	3000K	A	IP20	
250	C829910307	4017807336412	✓	3	SMD-LED	6	470	3000K	A	IP20	
250	829910407	4017807302752	✓	4	SMD-LED	6	470	3000K	A	IP20	
250	C829910407	4017807336429	✓	4	SMD-LED	6	470	3000K	A	IP20	
98	870610207	4017807299632	✓	2	SMD-LED	4,5	430	3000K	A+	IP20	
98	870610307	4017807299649	✓	3	SMD-LED	4,5	430	3000K	A+	IP20	
98	870610407	4017807299656	✓	4	SMD-LED	4,5	430	3000K	A+	IP20	
98	870670107	4017807299625	✓	1	SMD-LED	4,5	430	3000K	A+	IP20	
290	871010107	4017807281637	✓	1	E14	6	470	3000K	A+	IP20	92734
290	871010108	4017807281644	✓	1	E14	6	470	3000K	A+	IP20	92734
290	871010207	4017807281651	✓	2	E14	6	470	3000K	A+	IP20	92734
290	871010208	4017807281668	✓	2	E14	6	470	3000K	A+	IP20	92734
290	871010307	4017807281675	✓	3	E14	6	470	3000K	A+	IP20	92734
290	871010308	4017807281682	✓	3	E14	6	470	3000K	A+	IP20	92734
290	871010407	4017807281712	✓	4	E14	6	470	3000K	A+	IP20	92734
290	871010408	4017807281729	✓	4	E14	6	470	3000K	A+	IP20	92734
290	871010607	4017807281736	✓	6	E14	6	470	3000K	A+	IP20	92734
290	871010608	4017807281743	✓	6	E14	6	470	3000K	A+	IP20	92734



Seite Page	Artikel-Nr. Product No.	EAN-Nummer EAN-Number	incl. 	#	Socket Fitting	Watt Watt	Lumen Lumen	Kelvin Kelvin	EEK (874/2012)	IP IP	Ersatzteile Spare parts
290	871090307	4017807281699	✓	3	E14	6	470	3000K	A+	IP20	92734
290	871090308	4017807281705	✓	3	E14	6	470	3000K	A+	IP20	92734
294	871410107	4017807261820	✓	1	E14	4	320	3000K	A+	IP20	92680
294	871410207	4017807261837	✓	2	E14	4	320	3000K	A+	IP20	92680
294	871410307	4017807261844	✓	3	E14	4	320	3000K	A+	IP20	92680
294	871410407	4017807261851	✓	4	E14	4	320	3000K	A+	IP20	92680
294	871410607	4017807261868	✓	6	E14	4	320	3000K	A+	IP20	92680
286	871510207	4017807284904	✓	2	G9	3,5	300	3000K	A+	IP20	92739
286	871510208	4017807297744	✓	2	G9	3,5	300	3000K	A+	IP20	92739
286	871510407	4017807284966	✓	4	G9	3,5	300	3000K	A+	IP20	92739
286	871510408	4017807297768	✓	4	G9	3,5	300	3000K	A+	IP20	92739
286	871510607	4017807284980	✓	6	G9	3,5	300	3000K	A+	IP20	92739
286	871510608	4017807297775	✓	6	G9	3,5	300	3000K	A+	IP20	92739
286	871570107	4017807284898	✓	1	G9	3,5	300	3000K	A+	IP20	92739
286	871570108	4017807297737	✓	1	G9	3,5	300	3000K	A+	IP20	92739
286	871590307	4017807284942	✓	3	G9	3,5	300	3000K	A+	IP20	92739
286	871590308	4017807297751	✓	3	G9	3,5	300	3000K	A+	IP20	92739
94	871810205	4017807294033	✓	2	SMD-LED	11	1100	3000K	A+	IP20	
94	871810405	4017807294040	✓	4	SMD-LED	11	1100	3000K	A+	IP20	
242	871910106	4017807294217	✓	1	SMD-LED	4,3	400	3000K	A+	IP20	
242	871910206	4017807294224	✓	2	SMD-LED	4,3	400	3000K	A+	IP20	
242	871910306	4017807294231	✓	3	SMD-LED	4,3	400	3000K	A+	IP20	
242	871910406	4017807294248	✓	4	SMD-LED	4,3	400	3000K	A+	IP20	
242	871910606	4017807294255	✓	6	SMD-LED	4,3	400	3000K	A+	IP20	
80	872010206	4017807294132	✓	2	SMD-LED	4,3	400	3000K	A+	IP20	
80	872010306	4017807295498	✓	3	SMD-LED	4,3	400	3000K	A+	IP20	
80	872010406	4017807294149	✓	4	SMD-LED	4,3	400	3000K	A+	IP20	
80	872010606	4017807294156	✓	6	SMD-LED	4,3	400	3000K	A+	IP20	
80	872070106	4017807294125	✓	1	SMD-LED	4,3	400	3000K	A+	IP20	
278	872810101	4017807262209	✓	1	SMD-LED	3,8	350	3100K	A+	IP20	
276	872810106	4017807262216	✓	1	SMD-LED	3,8	350	3100K	A+	IP20	
278	872810201	4017807262223	✓	2	SMD-LED	3,8	350	3100K	A+	IP20	
276	872810206	4017807262230	✓	2	SMD-LED	3,8	350	3100K	A+	IP20	
278	872810401	4017807262261	✓	4	SMD-LED	3,8	350	3100K	A+	IP20	
276	872810406	4017807262278	✓	4	SMD-LED	3,8	350	3100K	A+	IP20	
278	872810601	4017807262308	✓	6	SMD-LED	3,8	350	3100K	A+	IP20	
276	872810606	4017807262315	✓	6	SMD-LED	3,8	350	3100K	A+	IP20	
278	872830301	4017807262247	✓	3	SMD-LED	3,8	350	3100K	A+	IP20	
276	872830306	4017807262254	✓	3	SMD-LED	3,8	350	3100K	A+	IP20	
278	872880101	4017807265941	✓	1	SMD-LED	3,8	350	3100K	A+	IP20	
276	872880106	4017807265958	✓	1	SMD-LED	3,8	350	3100K	A+	IP20	
254	873110307	4017807302615	✓	3	SMD-LED	6	550	3000K	A+	IP20	
256	873110331	4017807302622	✓	3	SMD-LED	6	550	3000K	A+	IP20	
254	873110407	4017807302639	✓	4	SMD-LED	6	550	3000K	A+	IP20	
256	873110431	4017807302646	✓	4	SMD-LED	6	550	3000K	A+	IP20	
254	873110607	4017807302653	✓	6	SMD-LED	6	550	3000K	A+	IP20	
256	873110631	4017807302660	✓	6	SMD-LED	6	550	3000K	A+	IP20	
254	873170107	4017807302578	✓	1	SMD-LED	6	550	3000K	A+	IP20	
256	873170131	4017807302585	✓	1	SMD-LED	6	550	3000K	A+	IP20	
254	873170207	4017807302592	✓	2	SMD-LED	6	550	3000K	A+	IP20	
256	873170231	4017807302608	✓	2	SMD-LED	6	550	3000K	A+	IP20	
274	874210106	4017807288353	✓	1	SMD-LED	3,5	370	3000K	A++	IP20	
274	874210206	4017807288360	✓	2	SMD-LED	3,5	370	3000K	A++	IP20	
274	874210306	4017807288377	✓	3	SMD-LED	3,5	370	3000K	A++	IP20	
274	874210406	4017807288407	✓	4	SMD-LED	3,5	370	3000K	A++	IP20	

Seite Page	Artikel-Nr. Product No.	EAN-Nummer EAN-Number	incl. 	#	Socket Fitting	Watt Watt	Lumen Lumen	Kelvin Kelvin	EEK (874/2012)	IP IP	Ersatzteile Spare parts
274	874210606	4017807288384	✓	6	SMD-LED	3,5	370	3000K	A++	IP20	
90	874310206	4017807281866	✓	2	SMD-LED	5	450	3000K	A+	IP20	
90	874310306	4017807281873	✓	3	SMD-LED	5	450	3000K	A+	IP20	
90	874310406	4017807281880	✓	4	SMD-LED	5	450	3000K	A+	IP20	
90	874310606	4017807281897	✓	6	SMD-LED	5	450	3000K	A+	IP20	
90	874370106	4017807281859	✓	1	SMD-LED	5	450	3000K	A+	IP20	
248	874410306	4017807267280	✓	3	SMD-LED	4,5	400	3000K	A+	IP20	
248	874410406	4017807267297	✓	4	SMD-LED	4,5	400	3000K	A+	IP20	
248	874410606	4017807267303	✓	6	SMD-LED	4,5	400	3000K	A+	IP20	
248	874470106	4017807267266	✓	1	SMD-LED	4,5	400	3000K	A+	IP20	
248	874470206	4017807267273	✓	2	SMD-LED	4,5	400	3000K	A+	IP20	
266	875810106	4017807299328	✓	1	SMD-LED	3,8	330	3000K	A+	IP20	
266	875810206	4017807299335	✓	2	SMD-LED	3,8	330	3000K	A+	IP20	
266	875810306	4017807299342	✓	3	SMD-LED	3,8	330	3000K	A+	IP20	
266	875810406	4017807299359	✓	4	SMD-LED	3,8	330	3000K	A+	IP20	
266	875810606	4017807299366	✓	6	SMD-LED	3,8	330	3000K	A+	IP20	
102	875910106	4017807285932	✓	1	SMD-LED	3,8	350	3000K	A+	IP20	
102	875910206	4017807285949	✓	2	SMD-LED	3,8	350	3000K	A+	IP20	
102	875910406	4017807285963	✓	4	SMD-LED	3,8	350	3000K	A+	IP20	
102	875910606	4017807285970	✓	6	SMD-LED	3,8	350	3000K	A+	IP20	
102	875990306	4017807285956	✓	3	SMD-LED	3,8	350	3000K	A+	IP20	
288	876410107	4017807293883	✓	1	G9	2,5	200	3000K	A+	IP20	92770
288	876410307	4017807293890	✓	2	G9	2,5	200	3000K	A+	IP20	92770
			✓	1	SMD-LED	3	300	3000K	A+		
288	876410507	4017807293913	✓	4	G9	2,5	200	3000K	A+	IP20	92770
			✓	1	SMD-LED	3	300	3000K	A+		
288	876410907	4017807293920	✓	8	G9	2,5	200	3000K	A+	IP20	92770
			✓	1	SMD-LED	3	300	3000K	A+		
288	876490407	4017807293906	✓	3	G9	2,5	200	3000K	A+	IP20	92770
			✓	1	SMD-LED	3	300	3000K	A+		
82	877110207	4017807277784	✓	2	SMD-LED	4,5	400	3000K	A+	IP20	92764
82	877110208	4017807278859	✓	2	SMD-LED	4,5	400	3000K	A+	IP20	92764-08
82	877110307	4017807277791	✓	3	SMD-LED	4,5	400	3000K	A+	IP20	92764
82	877110308	4017807278866	✓	3	SMD-LED	4,5	400	3000K	A+	IP20	92764-08
82	877110407	4017807277807	✓	4	SMD-LED	4,5	400	3000K	A+	IP20	92764
82	877110408	4017807278873	✓	4	SMD-LED	4,5	400	3000K	A+	IP20	92764-08
82	877110607	4017807277814	✓	6	SMD-LED	4,5	400	3000K	A+	IP20	92764
82	877110608	4017807278880	✓	6	SMD-LED	4,5	400	3000K	A+	IP20	92764-08
82	877170107	4017807277777	✓	1	SMD-LED	4,5	400	3000K	A+	IP20	92764
82	877170108	4017807278897	✓	1	SMD-LED	4,5	400	3000K	A+	IP20	92764-08
244	877910506	4017807275605	✓	3	SMD-LED	4,5	400	3000K	A+	IP20	92764
			✓	2	SMD-LED	4,5	400	3000K	A+		
244	877910706	4017807274585	✓	4	SMD-LED	4,5	400	3000K	A+	IP20	92764
			✓	3	SMD-LED	4,5	400	3000K	A+		
244	877911106	4017807274615	✓	6	SMD-LED	3,2	300	3000K	A+	IP20	92764
			✓	5	SMD-LED	3,2	300	3000K	A++		
244	877970306	4017807274578	✓	2	SMD-LED	4,5	400	3000K	A+	IP20	92764
			✓	1	SMD-LED	4,5	400	3000K	A+		
262	878610206	4017807281989	✓	2	SMD-LED	4,5	430	3000K	A+	IP20	92766
262	878610306	4017807281996	✓	3	SMD-LED	4,5	430	3000K	A+	IP20	92766
262	878610406	4017807282009	✓	4	SMD-LED	4,5	430	3000K	A+	IP20	92766
262	878610606	4017807282016	✓	6	SMD-LED	4,5	430	3000K	A+	IP20	92766
262	878670106	4017807281972	✓	1	SMD-LED	4,5	430	3000K	A+	IP20	92766
260	878710206	4017807261400	✓	2	SMD-LED	4,5	400	3000K	A+	IP20	92677
260	878710306	4017807261417	✓	3	SMD-LED	4,5	400	3000K	A+	IP20	92677

Seite Page	Artikel-Nr. Product No.	EAN-Nummer EAN-Number	incl. 	#	Socket Fitting	Watt Watt	Lumen Lumen	Kelvin Kelvin	EEK (874/2012)	IP IP	Ersatzteile Spare parts
260	878710406	4017807261424	✓	4	SMD-LED	4,5	400	3000K	A+	IP20	92677
260	878710606	4017807261431	✓	6	SMD-LED	4,5	400	3000K	A+	IP20	92677
260	878770106	4017807261394	✓	1	SMD-LED	4,5	400	3000K	A+	IP20	92677
76	879610207	4017807286847	✓	2	SMD-LED	4,3	460	3000K	A+	IP20	
76	879610307	4017807286854	✓	3	SMD-LED	4,3	460	3000K	A+	IP20	
76	879610407	4017807286861	✓	4	SMD-LED	4,3	460	3000K	A+	IP20	
507	8801211-06	4017807147469	✓	1	G9	28	370	2800K	C	IP21	9574
507	8801221-06	4017807147476	✓	2	G9	28	370	2800K	C	IP21	9574
507	8801231-06	4017807147483	✓	3	G9	28	370	2800K	C	IP21	9574
507	8801331-06	4017807147490	✓	3	G9	28	370	2800K	C	IP21	9574
406	8911211-07	4017807118780		1	E14	max. 40			A++ ... E	IP20	9568-07
406	8951211-07	4017807118827	✓	1	GU10	35	240	2800K	D	IP20	
406	898470107	4017807215779	✓	1	G9	28	370	2800K	C	IP20	92247
517	910-35	4017807062021		1	GU10	35	240	2800K	D	IPX0	
516	916-30	4017807287189		1	GU5.3	3	260	3000K	A+	IPX0	
517	919-18	4017807233223		1	G9	18	204	2800K	C	IPX0	
517	919-28	4017807202816		1	G9	28	370	2800K	C	IPX0	
517	919-33	4017807250886		1	G9	33	458	2800K	C	IPX0	
516	929-220	4017807293319		1	G9	2	180	3000K	A++	IPX0	
516	929-235	4017807283143		1	G9	3,5	300	3000K	A+	IPX0	
516	929-25	4017807249248		1	G9	2	170	3000K	A+	IPX0	
517	930-20	4017807185669		1	G4	20	260	2800K	C	IPX0	
517	930-23	4017807188066		1	R7S	230	4650	2800K	C	IPX0	
517	945-23	4017807188134		1	R7S	230	4650	2800K	C	IPX0	
516	955-250	4017807277081		1	GU10	5	400	3000K	A+	IPX0	
516	955-50	4017807277074		1	GU10	5	400	3000K	A+	IPX0	
516	955-55	4017807277098		1	E14	5	400	3000K	A+	IPX0	
516	955-60	4017807277104		1	GU10	6	400	3000K	A+	IPX0	
516	956-230	4017807277067		1	GU10	3	230	3000K	A+	IPX0	
516	956-30	4017807277050		1	GU10	3	230	3000K	A+	IPX0	
516	956-53	4017807300376		1	GU10	5	400	3000K	A+	IPX0	
516	956-55	4017807300369		1	GU10	5	400	3000K	A+	IPX0	
518	960-18	4017807207507		1	E14	18	204	2800K	C	IPX0	
518	960-28	4017807207514		1	E14	28	370	2800K	C	IPX0	
518	962-28	4017807207521		1	E14	28	370	2800K	C	IPX0	
518	964-18	4017807207552		1	E14	18	204	2800K	C	IPX0	
518	964-28	4017807207569		1	E14	28	370	2800K	C	IPX0	
518	965-52	4017807243819		1	E27	52	825	2800K	C	IPX0	
518	966-28	4017807207606		1	E27	28	370	2800K	C	IPX0	
518	966-42	4017807207620		1	E27	42	625	2800K	C	IPX0	
517	967-50	4017807112481		1	GU10	50	310	2800K	D	IPX0	
517	967-53	4017807162004		1	GU10	50	310	2800K	D	IPX0	
518	973-40	4017807187298		1	E14	40	380	2800K	E	IPX0	
515	983-10	4017807282658		1	E14	4		rot/red		IPX0	
515	983-12	4017807282665		1	E14	4		blau/blue		IPX0	
515	983-15	4017807282672		1	E14	4		grün/green		IPX0	
515	983-40	4017807240566		1	E14	4	320	3000K	A+	IPX0	
513	983-400	4017807302097		1	E14	4	470	3000K	A++	IPX0	
515	983-43	4017807260540		1	E14	4	320	3000K	A+	IPX0	
515	983-60	4017807279214		1	E14	6	470	3000K	A+	IPX0	
515	983-63	4017807279221		1	E14	6	470	3000K	A+	IPX0	
515	983-66	4017807300345		1	E14	6	470	3000K	A+	IPX0	
515	986-10	4017807282689		1	E27	4		rot/red		IPX0	
515	986-12	4017807282696		1	E27	4		blau/blue		IPX0	
515	986-15	4017807282702		1	E27	4		grün/green		IPX0	

Seite Page	Artikel-Nr. Product No.	EAN-Nummer EAN-Number	incl. 	#	Socket Fitting	Watt Watt	Lumen Lumen	Kelvin Kelvin	EEK (874/2012)	IP IP	Ersatzteile Spare parts
515	986-40	4017807268782		1	E27	4	320	3000K	A+	IPX0	
515	986-43	4017807268799		1	E27	4	320	3000K	A+	IPX0	
515	986-60	4017807280647		1	E27	6	470	3000K	A+	IPX0	
515	986-63	4017807280654		1	E27	6	470	3000K	A+	IPX0	
514	987-10	4017807277043		1	E27	10	806	3000K	A+	IPX0	
512	987-2400	4017807303933		1	E27	4	470	3000K	A++	IPX0	
514	987-40	4017807240665		1	E27	4	310	3000K	A+	IPX0	
512	987-400	4017807287509		1	E27	4	400	3000K	A+	IPX0	
514	987-60	4017807279252		1	E27	6	470	3000K	A+	IPX0	
513	987-600	4017807288056		1	E27	6	600	3000K	A+	IPX0	
512	987-660	4017807300314		1	E27	6	600	3000K	A+	IPX0	
513	987-679	4017807288049		1	E27	6	420	2700K	A+	IPX0	
514	988-10	4017807300338		1	E27	10	806	3000K	A+	IPX0	
514	988-100	4017807258264		1	E27	10	806	3000K	A+	IPX0	
514	988-250	4017807277289		1	E27	5	400	3000K	A+	IPX0	
514	988-50	4017807277036		1	E27	5	400	3000K	A+	IPX0	
514	988-60	4017807277753		1	E27	6	470	3000K	A+	IPX0	
512	988-600	4017807287516		1	E27	6	600	3000K	A+	IPX0	
512	988-660	4017807300321		1	E27	6	600	3000K	A+	IPX0	
512	988-679	4017807287530		1	E27	6	420	2700K	A+	IPX0	
515	989-40	4017807240597		1	E14	4	320	3000K	A+	IPX0	
513	989-400	4017807287486		1	E14	4	400	3000K	A++	IPX0	
515	989-43	4017807260557		1	E14	4	320	3000K	A+	IPX0	
513	989-479	4017807287523		1	E14	4	280	2700K	A+	IPX0	
515	989-60	4017807279238		1	E14	6	470	3000K	A+	IPX0	
515	989-63	4017807279245		1	E14	6	470	3000K	A+	IPX0	
515	989-66	4017807300352		1	E14	6	470	3000K	A+	IPX0	
515	990-40	4017807240610		1	E14	4	320	3000K	A+	IPX0	
513	990-400	4017807287493		1	E14	4	400	3000K	A++	IPX0	

TRIO behält sich das Recht vor, zu jeder Zeit, notwendige Änderungen oder Aktualisierungen der in diesem Katalog enthaltenen Produkte vorzunehmen. • TRIO reserves the right to carry out any time, necessary changes or updates of the products in this catalogue. • TRIO se réserve le droit d'apporter à tout moment les modifications ou actualisations nécessaires aux produits dans ce catalogue. • TRIO behoudt zich het recht voor op ieder moment noodzakelijke wijzigingen of updates aan de producten in deze catalogus door te voeren. • TRIO se reserva , en todo momento, el derecho a realizar las modificaciones o actualizaciones que considere necesarias para cualquier producto de este catálogo. • TRIO si riserva il diritto di apportare, in qualunque momento, tutte le modifiche necessarie ai prodotti di questo catalogo. • TRIO-ul își rezervă dreptul de a face oricând orice modificări sau actualizări necesare pentru produsele din acest catalog. • TRIO pidättää oikeuden tehdä muutoksia tai päivittää tuotteita tässä luettelossa. • TRIO zastrzega sobie prawo do wprowadzania w dowolnym czasie zmian lub aktualizacji produktów zawartych w katalogu. • TRIO bu katalog ürünleri için gerekli güncellemeleri ve düzenlemeleri herhangi bir zamanda yapma hakkını saklı tutar.



## TRIO Leuchten GmbH

Dieselstraße 4  
D-59823 Arnsberg  
Tel.: +49 (0) 29 31 / 96 66 - 0  
Fax: +49 (0) 29 31 / 96 66 - 28  
E-Mail: [info@trio-leuchten.de](mailto:info@trio-leuchten.de)  
[www.trio-leuchten.de](http://www.trio-leuchten.de)

### Niedersachsen, Schleswig-Holstein

**Bernd Schneider**  
Fax: +49 (0) 41 34 / 86 80  
E-Mail: [buksmelbeck@gmx.de](mailto:buksmelbeck@gmx.de)

### Nordrhein-Westfalen

**Antonio Capizzi**  
Fax: +49 (0) 23 81 / 41 74 65  
E-Mail: [capizziantonio@aol.com](mailto:capizziantonio@aol.com)

### Saarland, Rheinland-Pfalz, Hessen

**Christian Teller**  
E-Mail: [christian.teller@trio-leuchten.de](mailto:christian.teller@trio-leuchten.de)

### Baden Württemberg

**Steffen Lutz**  
Fax: +41 (0) 7 16 71 / 23 84  
E-Mail: [skl-mobilo@bluewin.ch](mailto:skl-mobilo@bluewin.ch)

### Bayern, Hessen

**Martin Kluge**  
Fax: +49 (0) 95 33 / 98 00 44  
E-Mail: [martin.kluge@trio-leuchten.de](mailto:martin.kluge@trio-leuchten.de)

### Berlin, Brandenburg, Meckl.-Vorpommern, Sachsen, Sachsen Anhalt, Thüringen

**Jörg Bumke**  
Fax: +49 (0) 3 55 / 49 39 87 56  
E-Mail: [joerg.bumke@trio-leuchten.de](mailto:joerg.bumke@trio-leuchten.de)

### Österreich

**Horst Faltlhauser**  
E-Mail: [hfaltlhauser@aol.com](mailto:hfaltlhauser@aol.com)

### Schweiz

**TRIO Leuchten GmbH**  
Tel.: +49 (0) 29 31 / 96 66 - 0  
Fax: +49 (0) 29 31 / 96 66 - 28  
E-Mail: [info@trio-leuchten.de](mailto:info@trio-leuchten.de)

## TRIO International GmbH

Dieselstraße 4  
D-59823 Arnsberg  
Tel.: +49 (0) 29 31 / 96 66 - 587  
Fax: +49 (0) 29 31 / 96 66 - 56  
E-Mail: [info@trio-lighting.com](mailto:info@trio-lighting.com)  
[www.trio-lighting.com](http://www.trio-lighting.com)

### France

**Christophe Meulien**  
7 Rue Denfert Rocherau  
83390 Cuers  
Tel.: +33 (0) 6 34 29 57 03  
E-Mail: [cmeulien@gmail.com](mailto:cmeulien@gmail.com)  
Agent exclusif pour les départements  
4, 5, 6, 11, 13, 30, 34, 48, 66, 83 et 84

**Michel Salamand**  
6 bis rue François Villon  
56530 Queven  
Tel.: +33 (0) 6 61 62 73 27  
E-Mail: [michelsalaman@wanadoo.fr](mailto:michelsalaman@wanadoo.fr)  
Agent exclusif pour les départements  
14, 17, 22, 29, 35, 36, 37, 41, 44, 49, 50, 53,  
56, 61, 72, 79, 85 et 86

**Jean Louis Briche**  
56 rue de Sauvillers  
80110 Mailly Raineval  
Tel.: +33 (0) 9 62 20 43 78  
E-Mail: [jeanlouis.briche@orange.fr](mailto:jeanlouis.briche@orange.fr)  
Agent exclusif pour les départements  
02, 08, 10, 18, 21, 25, 39, 27, 28, 45, 51, 52, 54, 55,  
57, 58, 59, 60, 62, 67, 68, 70, 75, 77, 78, 80, 88, 89,  
90, 91, 92, 94 et 95

**Jean Barel**  
86 Chemin de Boudoun  
31620 Bouloc  
Tel.: +33 (0) 6 24 56 13 81  
E-Mail: [jeanbarel@wanadoo.fr](mailto:jeanbarel@wanadoo.fr)  
Agent exclusif pour les départements  
9, 12, 15, 16, 19, 24, 31, 32, 33, 40, 46, 47, 64, 65,  
81, 82 et 87

**Jean Marc Bossonney**  
150 allée des Dolines  
74330 Silligny  
Tel.: +33 (0) 6 83 68 69 51  
E-Mail: [jmbossonney@gmail.com](mailto:jmbossonney@gmail.com)  
Agent exclusif pour les départements  
1, 3, 7, 26, 38, 42, 43, 63, 69, 71, 73 et 74

### Italia

**TRIO Lighting Italia s.r.l**  
Via Padre Masciadri, 2 H  
IT-22066 Mariano Comense ( CO )  
Phone: +39 (0) 31 7 477 55  
Fax: +39 (0) 31 3 551 560  
E-Mail: [info.italia@trio-lighting.com](mailto:info.italia@trio-lighting.com)



[www.facebook.com/trioleuchten](http://www.facebook.com/trioleuchten)



### España

**TRIO Lighting Ibérica S.L.**  
Avda. Corts Catalanes, nº 9-11  
ES-08173 Sant Cugat del Valles  
Phone: +34 (0) 9 35 45 86 30  
Fax: +34 (0) 9 33 96 45 48  
E-Mail: [info.iberica@trio-lighting.com](mailto:info.iberica@trio-lighting.com)

### Türkiye

**TRIO Lighting Türkiye Ltd. Şti.**  
İnönü Mahllesi Kayışdağı Caddesi  
Münire İş Merkezi. No 28 K:2 D:2  
TR-34704 Atasehir - İstanbul  
Phone: +90 (0) 216 576 69 41  
Fax: +90 (0) 216 572 85 45  
E-Mail: [info.tuerkiye@trio-lighting.com](mailto:info.tuerkiye@trio-lighting.com)

### Suomi

**TRIO Lighting Scandinavia Oy**  
Kirvesmiehenkatu 4  
FI-00880 Helsinki  
Phone: +358 (0) 10 2313 390  
Fax: +358 (0) 10 2313 399  
E-Mail: [info.scandinavia@trio-lighting.com](mailto:info.scandinavia@trio-lighting.com)  
*Our Scandinavian organisation represents Trio also in  
Denmark, Sweden, Norway, Estonia, Latvia and Lithuania*

### Great Britain

**TRIO Lighting UK Ltd.**  
Unit 5, Hemmells Park Hemmells, Laidon  
Essex  
SS15 6GF  
Phone: +44 (0) 12 68 88 95 95  
Fax: +44 (0) 12 68 88 95 96  
E-Mail: [sales@trio-lightinguk.com](mailto:sales@trio-lightinguk.com)

### Nederlands

**TRIO International GmbH**  
Dieselstraße 4  
D-59823 Arnsberg  
**Karl Stok**  
E-Mail: [karl.stok@trio-lighting.com](mailto:karl.stok@trio-lighting.com)

### België/Belgique

**TRIO International GmbH**  
Dieselstraße 4  
D-59823 Arnsberg  
**Yves van den Berghe**  
E-Mail: [info.belgium@trio-lighting.com](mailto:info.belgium@trio-lighting.com)

### Romania

**TRIO International GmbH**  
Dieselstraße 4  
D-59823 Arnsberg  
**Gina Ionita**  
E-Mail: [info.romania@trio-lighting.com](mailto:info.romania@trio-lighting.com)

lichtforumnrw

[www.lichtforumnrw.de](http://www.lichtforumnrw.de)

**LICHTWOCHE**  
**SAUERLAND**  
05. - 09.03.2017





**TRIO Leuchten GmbH**

Dieselstraße 4  
D-59823 Arnsberg  
Tel.: +49 (0) 29 31 / 96 66 - 0  
Fax: +49 (0) 29 31 / 96 66 - 28  
E-Mail: [info@trio-leuchten.de](mailto:info@trio-leuchten.de)

[www.trio-leuchten.de](http://www.trio-leuchten.de)

**TRIO International GmbH**

Dieselstraße 4  
D-59823 Arnsberg  
Tel.: +49 (0) 29 31 / 96 66 - 587  
Fax: +49 (0) 29 31 / 96 66 - 56  
E-Mail: [info@trio-lighting.com](mailto:info@trio-lighting.com)

[www.trio-lighting.com](http://www.trio-lighting.com)

---