



RIO-LED

RIO

Homojen,
Uniform

Verimli,
Efficient

Dođal...
Natural

Yüksek enerji verimliliđi, farklı boyut ve uygulama seçenekleri ile RIO armatürler, iç mekanlarda dođal ve homojen aydınlatma sunarken aynı zamanda düşük enerji tüketimi sayesinde çevre dostudur.

Rio luminaires with high energy efficiency, different sizes and application preferences, provide natural and uniform lightening experience and environmental friendly with it's low energy consumption.

HIGH
Efficiency

120 lm/W

LED





Polyester elektrostatik toz boyalı /
Electrostatic polyester powder coated

Alüminyum çerçeve, sac gövde /
Extruded aluminium frame, sheet metal body

Yüksek geçirgenlikli satine PMMA veya PC opal difüzör /
High diffusion and transmission satin opal PMMA or PC diffuser

Homojen aydınlatma / Uniform illumination

MacAdam 3 LED renk toleransı /
Colour tolerance MacAdam 3

DALI, SwitchDIM ve Acil seçenekleri /
DALI, SwitchDIM and Emergency options

Özellikler / Specifications



Renk Seçenekleri / Colour Options



Beyaz
White

Fotometrik Bilgi / Photometric Data

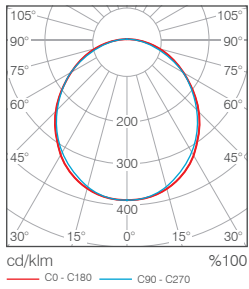

Tavan Bilgi / Ceiling Data

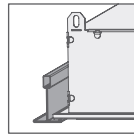

T15 veya T25 tavanlar /
T15 or T25 exposed T

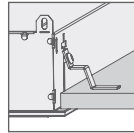

Alçı tavanlar /
Plaster board ceilings

Teknik Çizim / Technical Drawing

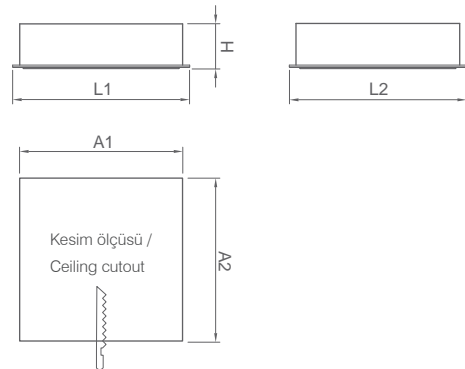

Teknik Bilgi / Technical Data

Güç (W)	Çıkış / Output Lumen (lm)	Verimlilik (lm/W)	CRI (Ra)	Renk Sıcaklığı Colour Temp. (K)	Ölçüler / Dimensions (mm)					Ağırlık Weight (kg)	Ürün Kodu Item Code
					A1	A2	L1	L2	H		
10,5W	1160	110	>80	3000	275	275	295	295	73	1,9	111 0 330 3 112
10,5W	1210	115	>80	4000	275	275	295	295	73	1,9	111 0 330 4 112
12,5W	1370	109	>80	3000	275	275	295	295	73	1,9	111 0 330 3 111
12,5W	1420	114	>80	4000	275	275	295	295	73	1,9	111 0 330 4 111

Ek Kod / Suffix Code

- (300) 3 saat Acil çıkış kiti / 3 hours Emergency gear
- (010) DALI

* Tavan tipini belirtiniz. / Please indicate type of ceiling.

** L demiri askı takımı, alçı tavanlar için / L brackets for plaster board ceilings

*** Lütfen daha fazla bilgi için satış temsilcileri ile görüşün. / Please contact for more information.



Polyester elektrostatik toz boyalı /
Electrostatic polyester powder coated

Alüminyum çerçeve, sac gövde /
Extruded aluminium frame, sheet metal body

Yüksek geçirgenlikli satine PMMA veya PC opal difüzör /
High diffusion and transmission satin opal PMMA or PC diffuser

Homojen aydınlatma / Uniform illumination

MacAdam 3 LED renk toleransı /
Colour tolerance MacAdam 3

DALI, SwitchDIM ve Acil seçenekleri /
DALI, SwitchDIM and Emergency options

Özellikler / Specifications



Renk Seçenekleri / Colour Options



Fotometrik Bilgi / Photometric Data

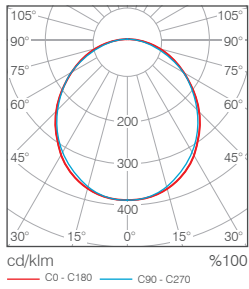

Tavan Bilgi / Ceiling Data

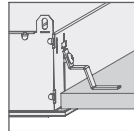
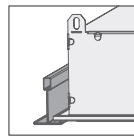

Teknik Çizim / Technical Drawing

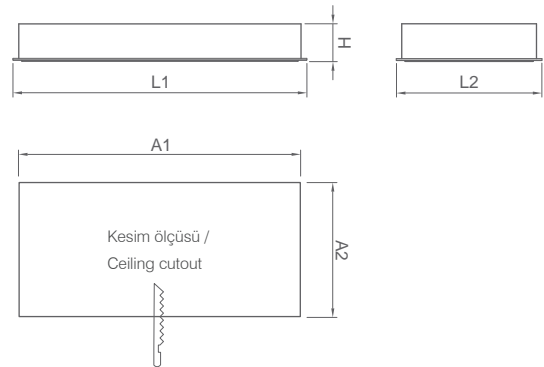

Teknik Bilgi / Technical Data

Güç (W)	Çıkış / Output (lm)	Verimlilik (lm/W)	CRI (Ra)	Renk Sıcaklığı / Colour Temp. (K)	Ölçüler / Dimensions (mm)					Ağırlık / Weight (kg)	Ürün Kodu / Item Code
					A1	A2	L1	L2	H		
17,2W	1960	114	>80	3000	575	275	595	295	73	2,9	111 0 360 3 113
17,2W	2050	120	>80	4000	575	275	595	295	73	2,9	111 0 360 4 113
21W	2325	111	>80	3000	575	275	595	295	73	2,9	111 0 360 3 112
21W	2430	116	>80	4000	575	275	595	295	73	2,9	111 0 360 4 112

Ek Kod / Suffix Code

- (300) 3 saat Acil çıkış kiti / 3 hours Emergency gear
- (010) DALI

* Tavan tipini belirtiniz. / Please indicate type of ceiling.

** L demiri askı takımı, alçı tavanlar için / L brackets for plaster board ceilings

*** Lütfen daha fazla bilgi için satış temsilcileri ile görüşün. / Please contact for more information.



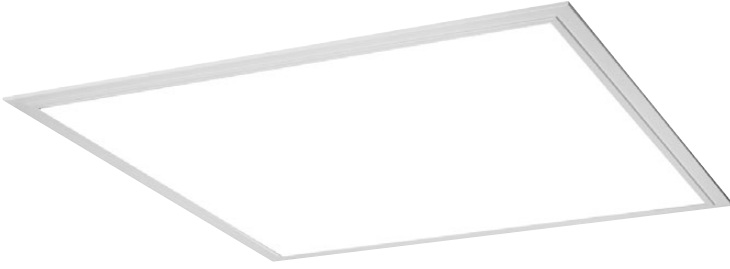

Polyester elektrostatik toz boyalı /
Electrostatic polyester powder coated

Alüminyum çerçeve, sac gövde /
Extruded aluminium frame, sheet metal body

Yüksek geçirgenlikli satine PMMA veya PC opal difüzör /
High diffusion and transmission satin opal PMMA or PC diffuser

Homojen aydınlatma / Uniform illumination

MacAdam 3 LED renk toleransı /
Colour tolerance MacAdam 3

DALI, SwitchDIM ve Acil seçenekleri /
DALI, SwitchDIM and Emergency options

Özellikler / Specifications



Renk Seçenekleri / Colour Options



Beyaz
White

Fotometrik Bilgi / Photometric Data

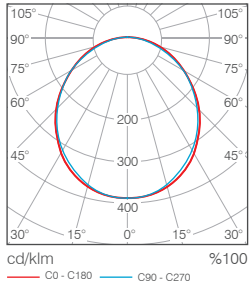

Tavan Bilgi / Ceiling Data

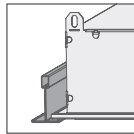

T15 veya T25 tavanlar /
T15 or T25 exposed T

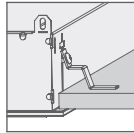

Alçı tavanlar /
Plaster board ceilings

Teknik Çizim / Technical Drawing

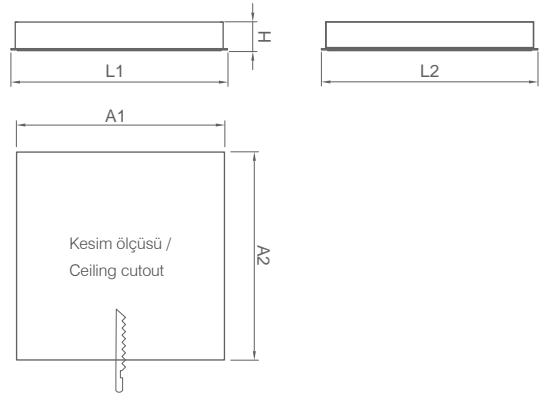

Teknik Bilgi / Technical Data

Güç (W)	Çıkış / Output (lm)	Verimlilik (lm/W)	CRI (Ra)	Renk Sıcaklığı / Colour Temp. (K)	Ölçüler / Dimensions (mm)					Ağırlık / Weight (kg)	Ürün Kodu / Item Code
					A1	A2	L1	L2	H		
34,4W	3920	114	>80	3000	575	575	595	595	73	5,5	111 0 660 3 113
34,4W	4100	120	>80	4000	575	575	595	595	73	5,5	111 0 660 4 113
42W	4650	111	>80	3000	575	575	595	595	73	5,5	111 0 660 3 112
42W	4860	116	>80	4000	575	575	595	595	73	5,5	111 0 660 4 112

Ek Kod / Suffix Code

- (300) 3 saat Acil çıkış kiti / 3 hours Emergency gear
- (010) DALI

* Tavan tipini belirtiniz. / Please indicate type of ceiling.

** L demiri askı takımı, alçı tavanlar için / L brackets for plaster board ceilings

*** Lütfen daha fazla bilgi için satış temsilcileri ile görüşün. / Please contact for more information.



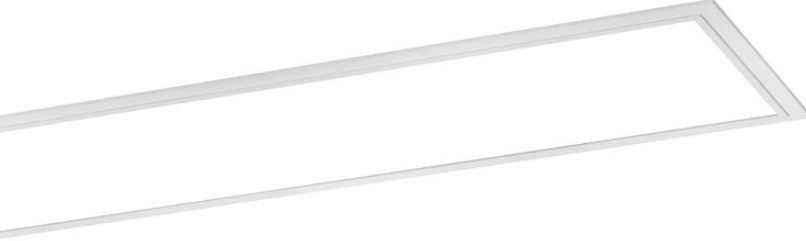

Polyester elektrostatik toz boyalı /
Electrostatic polyester powder coated

Alüminyum çerçeve, sac gövde /
Extruded aluminium frame, sheet metal body

Yüksek geçirgenlikli satine PMMA veya PC opal difüzör /
High diffusion and transmission satin opal PMMA or PC diffuser

Homojen aydınlatma / Uniform illumination

MacAdam 3 LED renk toleransı /
Colour tolerance MacAdam 3

DALI, SwitchDIM ve Acil seçenekleri /
DALI, SwitchDIM and Emergency options

Özellikler / Specifications



Renk Seçenekleri / Colour Options



Beyaz
White

Fotometrik Bilgi / Photometric Data

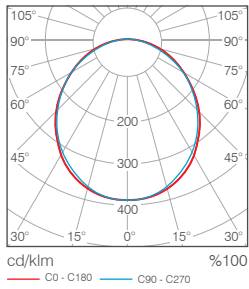

Tavan Bilgi / Ceiling Data

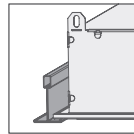

T15 veya T25 tavanlar /
T15 or T25 exposed T

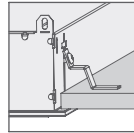

Alçı tavanlar /
Plaster board ceilings

Teknik Çizim / Technical Drawing

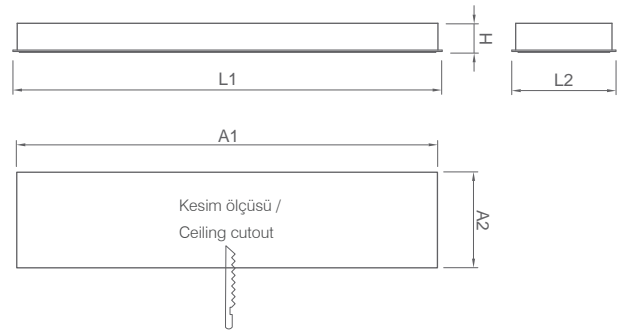

Teknik Bilgi / Technical Data

Güç (W)	Çıkış / Output (lm)	Verimlilik (lm/W)	CRI (Ra)	Renk Sıcaklığı (K)	Ölçüler / Dimensions (mm)	Ağırlık (kg)	Ürün Kodu (Item Code)
34,4W	3920	114	>80	3000	A1 1175 A2 275 L1 1195 L2 295 H 73	5,6	111 0 312 3 123
34,4W	4100	120	>80	4000	A1 1175 A2 275 L1 1195 L2 295 H 73	5,6	111 0 312 4 123
42W	4650	111	>80	3000	A1 1175 A2 275 L1 1195 L2 295 H 73	5,6	111 0 312 3 122
42W	4860	116	>80	4000	A1 1175 A2 275 L1 1195 L2 295 H 73	5,6	111 0 312 4 122

Ek Kod / Suffix Code

- (300) 3 saat Acil çıkış kiti / 3 hours Emergency gear
- (010) DALI

* Tavan tipini belirtiniz. / Please indicate type of ceiling.

** L demiri askı takımı, alçı tavanlar için / L brackets for plaster board ceilings

*** Lütfen daha fazla bilgi için satış temsilcileri ile görüşün. / Please contact for more information.





Polyester elektrostatik toz boyalı /
Electrostatic polyester powder coated

Alüminyum çerçeve, sac gövde /
Extruded aluminium frame, sheet metal body

Yüksek geçirgenlikli satine PMMA veya PC opal difüzör /
High diffusion and transmission satin opal PMMA or PC diffuser

Homojen aydınlatma / Uniform illumination

MacAdam 3 LED renk toleransı /
Colour tolerance MacAdam 3

DALI, SwitchDIM ve Acil seçenekleri /
DALI, SwitchDIM and Emergency options

Özellikler / Specifications



Renk Seçenekleri / Colour Options



Fotometrik Bilgi / Photometric Data

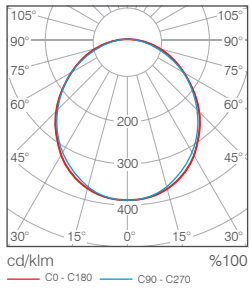

Tavan Bilgi / Ceiling Data

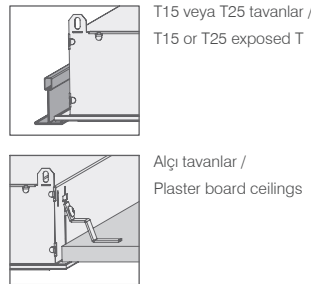

Teknik Çizim / Technical Drawing

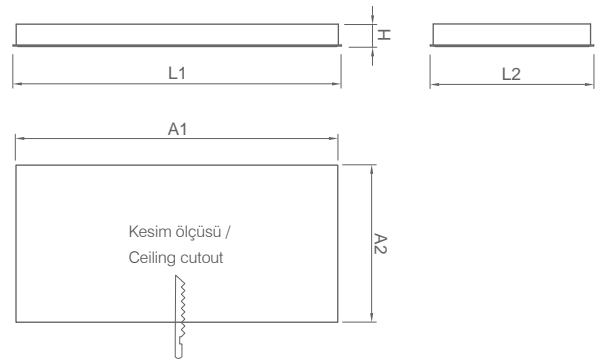

Teknik Bilgi / Technical Data

Güç (W)	Çıkış / Output (lm)	Verimlilik (lm/W)	CRI (Ra)	Renk Sıcaklığı (K)	Ölçüler / Dimensions (mm)	Ağırlık (kg)	Ürün Kodu (Item Code)
					A1 A2 L1 L2 H		
69W	7840	114	>80	3000	1175 575 1195 595 73	9,6	111 0 612 3 123
69W	8200	120	>80	4000	1175 575 1195 595 73	9,6	111 0 612 4 123
84W	9300	111	>80	3000	1175 575 1195 595 73	9,6	111 0 612 3 122
84W	9720	116	>80	4000	1175 575 1195 595 73	9,6	111 0 612 4 122

Ek Kod / Suffix Code

- (300) 3 saat Acil çıkış kiti / 3 hours Emergency gear
- (010) DALI

* Tavan tipini belirtiniz. / Please indicate type of ceiling.

** L demiri askı takımı, alçı tavanlar için / L brackets for plaster board ceilings

*** Lütfen daha fazla bilgi için satış temsilcileri ile görüşün. / Please contact for more information.





Polyester elektrostatik toz boyalı gövde /
Electrostatic polyester powder coated sheet metal body

Yüksek geçirgenlikli satine PMMA veya PC opal difüzör /
High diffusion and transmission satin opal PMMA or PC diffuser

Homojen aydınlatma / Uniform illumination

MacAdam 3 LED renk toleransı /
Colour tolerance MacAdam 3

DALI, SwitchDIM ve Acil seçenekleri /
DALI, SwitchDIM and Emergency options

Özellikler / Specifications



Renk Seçenekleri / Colour Options



Fotometrik Bilgi / Photometric Data

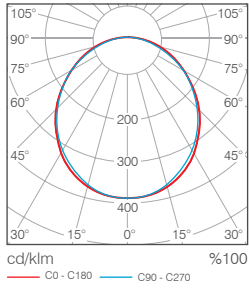

Tavan Bilgi / Ceiling Data

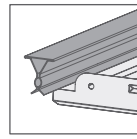

Teknik Çizim / Technical Drawing

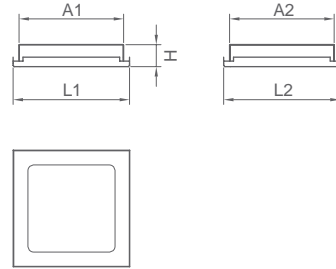

Teknik Bilgi / Technical Data

Güç (W)	Çıkış / Output (lm)	Verimlilik (lm/W)	CRI (Ra)	Renk Sıcaklığı / Colour Temp. (K)	Ölçüler / Dimensions (mm)					Ağırlık / Weight (kg)	Ürün Kodu / Item Code
					A1	A2	L1	L2	H		
10,5W	1160	110	>80	3000	265	265	300	300	73	1,5	113 0 330 3 112
10,5W	1210	115	>80	4000	265	265	300	300	73	1,5	113 0 330 4 112
12,5W	1370	109	>80	3000	265	265	300	300	73	1,5	113 0 330 3 111
12,5W	1420	114	>80	4000	265	265	300	300	73	1,5	113 0 330 4 111

Ek Kod / Suffix Code

- (300) 3 saat Acil çıkış kiti / 3 hours Emergency gear
- (010) DALI

* Tavan tipini belirtiniz. / Please indicate type of ceiling.

** Lütfen daha fazla bilgi için satış temsilcileri ile görüşün. / Please contact for more information.



RIO

Clip-in (Metal) Tavan Armatürler / Clip-in Ceiling Luminaires

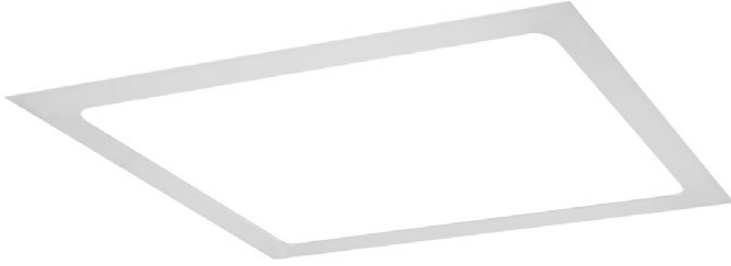

Polyester elektrostatik toz boyalı gövde /
Electrostatic polyester powder coated sheet metal body

Yüksek geçirgenlikli satine PMMA veya PC opal difüzör /
High diffusion and transmission satin opal PMMA or PC diffuser

Homojen aydınlatma / Uniform illumination

MacAdam 3 LED renk toleransı /
Colour tolerance MacAdam 3

DALI, SwitchDIM ve Acil seçenekleri /
DALI, SwitchDIM and Emergency options

Özellikler / Specifications



Renk Seçenekleri / Colour Options



Fotometrik Bilgi / Photometric Data

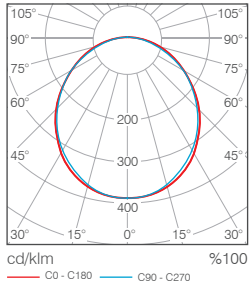

Tavan Bilgi / Ceiling Data

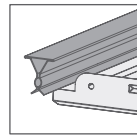

Clip-in tavan /
Clip-in ceiling

Teknik Çizim / Technical Drawing

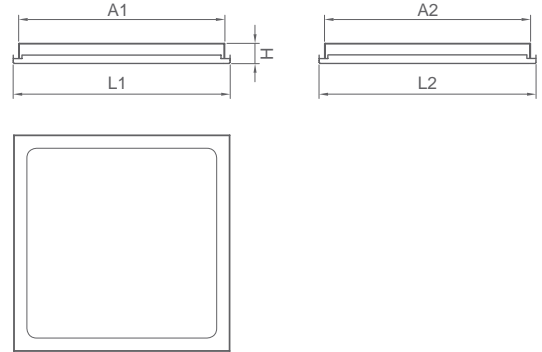

Teknik Bilgi / Technical Data

Güç (W)	Çıkış / Output (lm)	Verimlilik (lm/W)	CRI (Ra)	Renk Sıcaklığı (K)	Ölçüler / Dimensions (mm)					Ağırlık (kg)	Ürün Kodu / Item Code
					A1	A2	L1	L2	H		
34,4W	3920	114	>80	3000	565	565	600	600	73	5,3	113 0 660 3 113
34,4W	4100	120	>80	4000	565	565	600	600	73	5,3	113 0 660 4 113
42W	4650	111	>80	3000	565	565	600	600	73	5,3	113 0 660 3 112
42W	4860	116	>80	4000	565	565	600	600	73	5,3	113 0 660 4 112

Ek Kod / Suffix Code

- (300) 3 saat Acil çıkış kiti / 3 hours Emergency gear
- (010) DALI

* Tavan tipini belirtiniz. / Please indicate type of ceiling.

** Lütfen daha fazla bilgi için satış temsilcileri ile görüşün. / Please contact for more information.

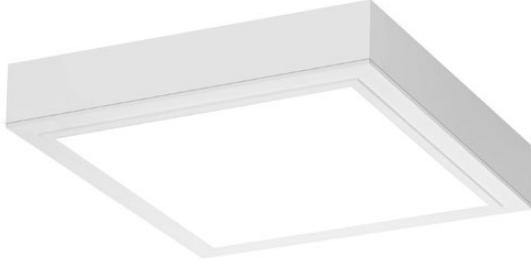

Polyester elektrostatik toz boyalı /
Electrostatic polyester powder coated

Alüminyum çerçeve, sac gövde /
Extruded aluminium frame, sheet metal body

Yüksek geçirgenlikli satine PMMA veya PC opal difüzör /
High diffusion and transmission satin opal PMMA or PC diffuser

Homojen aydınlatma / Uniform illumination

MacAdam 3 LED renk toleransı /
Small colour tolerance MacAdam 3

DALI, SwitchDIM ve Acil seçenekleri /
DALI, SwitchDIM and Emergency options

Özellikler / Specifications



Renk Seçenekleri / Colour Options



Fotometrik Bilgi / Photometric Data

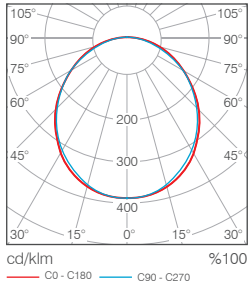

Uygulama Alanları / Applications

Ofisler / Offices
Eğitim Alanları / Educational Facilities
Mağazalar / Retails
Hastaneler / Hospitals and Wellness

Teknik Çizim / Technical Drawing

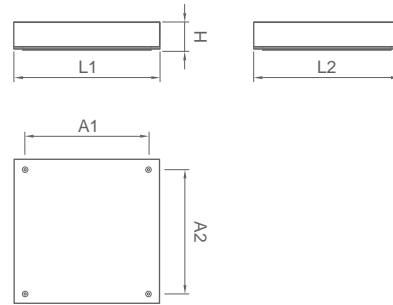

Teknik Bilgi / Technical Data

Güç (W)	Çıkış / Output (lm)	Verimlilik (lm/W)	CRI (Ra)	Renk Sıcaklığı (K)	Ölçüler / Dimensions (mm)	Ağırlık (kg)	Ürün Kodu (Item Code)
					A1 A2 L1 L2 H		
10,5W	1160	110	>80	3000	295 276 345 345 70	2	112 0 330 3 112
10,5W	1210	115	>80	4000	295 276 345 345 70	2	112 0 330 4 112
12,5W	1370	109	>80	3000	295 276 345 345 70	2	112 0 330 3 111
12,5W	1420	114	>80	4000	295 276 345 345 70	2	112 0 330 4 111

Ek Kod / Suffix Code

- (100) 1 saat Acil çıkış kiti / 1 hour Emergency gear
- (010) DALI



Polyester elektrostatik toz boyalı /
Electrostatic polyester powder coated

Alüminyum çerçeve, sac gövde /
Extruded aluminium frame, sheet metal body

Yüksek geçirgenlikli satine PMMA veya PC opal difüzör /
High diffusion and transmission satin opal PMMA or PC diffuser

Homojen aydınlatma / Uniform illumination

MacAdam 3 LED renk toleransı /
Small colour tolerance MacAdam 3

DALI, SwitchDIM ve Acil seçenekleri /
DALI, SwitchDIM and Emergency options

Özellikler / Specifications



Renk Seçenekleri / Colour Options



Fotometrik Bilgi / Photometric Data

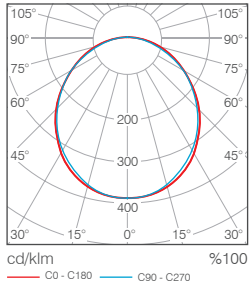

Uygulama Alanları / Applications

Ofisler / Offices
Eğitim Alanları / Educational Facilities
Mağazalar / Retails
Hastaneler / Hospitals and Wellness

Teknik Çizim / Technical Drawing

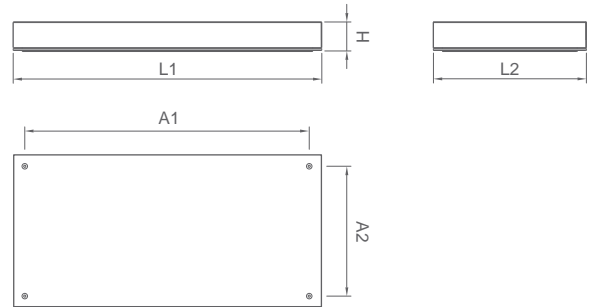

Teknik Bilgi / Technical Data

Güç (W)	Çıkış / Output (lm)	Verimlilik (lm/W)	CRI (Ra)	Renk Sıcaklığı / Colour Temp. (K)	Ölçüler / Dimensions (mm)					Ağırlık / Weight (kg)	Ürün Kodu / Item Code
					A1	A2	L1	L2	H		
17,2W	1960	114	>80	3000	545	276	595	345	70	3,4	112 0 360 3 113
17,2W	2050	120	>80	4000	545	276	595	345	70	3,4	112 0 360 4 113
21W	2325	111	>80	3000	545	276	595	345	70	3,4	112 0 360 3 112
21W	2430	116	>80	4000	545	276	595	345	70	3,4	112 0 360 4 112

Ek Kod / Suffix Code

- (100) 1 saat Acil çıkış kiti / 1 hour Emergency gear
- (010) DALI





Polyester elektrostatik toz boyalı /
Electrostatic polyester powder coated

Alüminyum çerçeve, sac gövde /
Extruded aluminium frame, sheet metal body

Yüksek geçirgenlikli satine PMMA veya PC opal difüzör /
High diffusion and transmission satin opal PMMA or PC diffuser

Homojen aydınlatma / Uniform illumination

MacAdam 3 LED renk toleransı /
Small colour tolerance MacAdam 3

DALI, SwitchDIM ve Acil seçenekleri /
DALI, SwitchDIM and Emergency options

Özellikler / Specifications



Renk Seçenekleri / Colour Options



Beyaz
White

Fotometrik Bilgi / Photometric Data

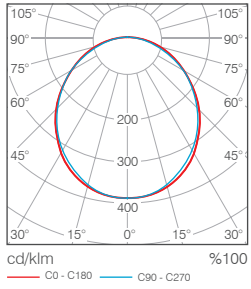

Uygulama Alanları / Applications

Ofisler / Offices
Eğitim Alanları / Educational Facilities
Mağazalar / Retails
Hastaneler / Hospitals and Wellness

Teknik Çizim / Technical Drawing

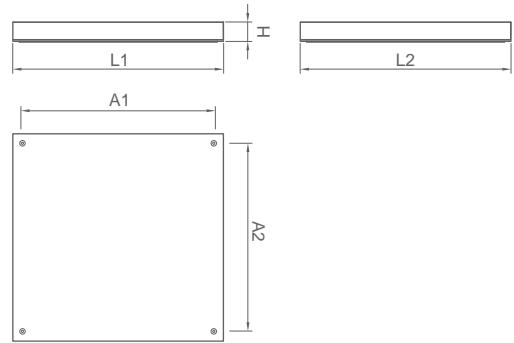

Teknik Bilgi / Technical Data

Güç (W)	Çıkış / Output (lm)	Verimlilik (lm/W)	CRI (Ra)	Renk Sıcaklığı / Colour Temp. (K)	Ölçüler / Dimensions (mm)					Ağırlık / Weight (kg)	Ürün Kodu / Item Code
					A1	A2	L1	L2	H		
34,4W	3920	114	>80	3000	545	546	595	595	70	5,8	112 0 660 3 113
34,4W	4100	120	>80	4000	545	546	595	595	70	5,8	112 0 660 4 113
42W	4650	111	>80	3000	545	546	595	595	70	5,8	112 0 660 3 112
42W	4860	116	>80	4000	545	546	595	595	70	5,8	112 0 660 4 112

Ek Kod / Suffix Code

- (100) 1 saat Acil çıkış kiti / 1 hour Emergency gear
- (010) DALI



Polyester elektrostatik toz boyalı /
Electrostatic polyester powder coated

Alüminyum çerçeve, sac gövde /
Extruded aluminium frame, sheet metal body

Yüksek geçirgenlikli satine PMMA veya PC opal difüzör /
High diffusion and transmission satin opal PMMA or PC diffuser

Homojen aydınlatma / Uniform illumination

MacAdam 3 LED renk toleransı /
Small colour tolerance MacAdam 3

DALI, SwitchDIM ve Acil seçenekleri /
DALI, SwitchDIM and Emergency options

Özellikler / Specifications



Renk Seçenekleri / Colour Options



Fotometrik Bilgi / Photometric Data

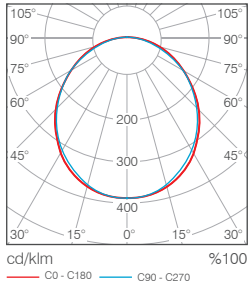

Uygulama Alanları / Applications

Ofisler / Offices
Eğitim Alanları / Educational Facilities
Mağazalar / Retails
Hastaneler / Hospitals and Wellness

Teknik Çizim / Technical Drawing

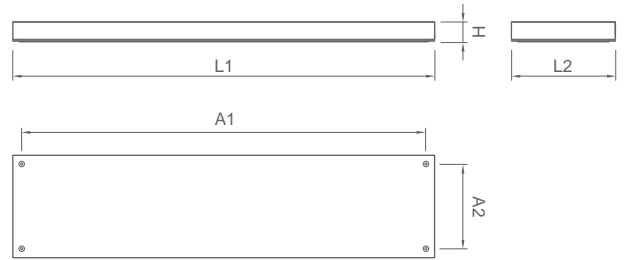

Teknik Bilgi / Technical Data

Güç (W)	Çıkış / Output (lm)	Verimlilik (lm/W)	CRI (Ra)	Renk Sıcaklığı (K)	Ölçüler / Dimensions (mm)	Ağırlık (kg)	Ürün Kodu / Item Code
34,4W	3920	114	>80	3000	A1 A2 L1 L2 H	5,9	112 0 312 3 113
34,4W	4100	120	>80	4000	A1 A2 L1 L2 H	5,9	112 0 312 4 113
42W	4650	111	>80	3000	A1 A2 L1 L2 H	5,9	112 0 312 3 112
42W	4860	116	>80	4000	A1 A2 L1 L2 H	5,9	112 0 312 4 112

Ek Kod / Suffix Code

- (100) 1 saat Acil çıkış kiti / 1 hour Emergency gear
- (010) DALI



Polyester elektrostatik toz boyalı /
Electrostatic polyester powder coated

Alüminyum çerçeve, sac gövde /
Extruded aluminium frame, sheet metal body

Yüksek geçirgenlikli satine PMMA veya PC opal difüzör /
High diffusion and transmission satin opal PMMA or PC diffuser

Homojen aydınlatma / Uniform illumination

MacAdam 3 LED renk toleransı /
Small colour tolerance MacAdam 3

DALI, SwitchDIM ve Acil seçenekleri /
DALI, SwitchDIM and Emergency options

Özellikler / Specifications



Renk Seçenekleri / Colour Options



Beyaz
White

Fotometrik Bilgi / Photometric Data

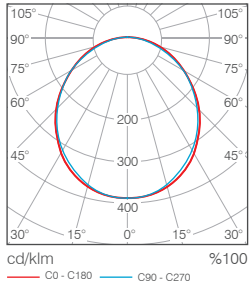

Uygulama Alanları / Applications

Ofisler / Offices
Eğitim Alanları / Educational Facilities
Mağazalar / Retails
Hastaneler / Hospitals and Wellness

Teknik Çizim / Technical Drawing

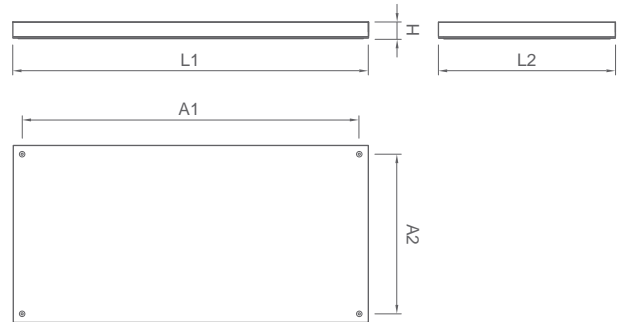

Teknik Bilgi / Technical Data

Güç (W)	Çıkış / Output (lm)	Verimlilik (lm/W)	CRI (Ra)	Renk Sıcaklığı (K)	Ölçüler / Dimensions (mm)					Ağırlık (kg)	Ürün Kodu / Item Code
					A1	A2	L1	L2	H		
69W	7840	114	>80	3000	1065	546	1095	595	70	11	112 0 612 3 113
69W	8200	120	>80	4000	1065	546	1095	595	70	11	112 0 612 4 113
84W	9300	111	>80	3000	1065	546	1095	595	70	11	112 0 612 3 112
84W	9720	116	>80	4000	1065	546	1095	595	70	11	112 0 612 4 112

Ek Kod / Suffix Code

- (100) 1 saat Acil çıkış kiti / 1 hour Emergency gear
- (010) DALI

NEW RIO

Sıva Üstü - Sarkit Armatürler / Surface Mounted - Suspended Luminaires



Farklı renk seçeneqli polyester elektrostatik toz boyalı /
Electrostatic polyester powder coated with different color options

Alüminyum çerçeve, sac gövde /
Extruded aluminium frame, sheet metal body

Yüksek geçirgenlikli satine PMMA veya PC opal difüzör /
High diffusion and transmission satin opal PMMA or PC diffuser

Homojen aydınlatma / Uniform illumination

MacAdam 3 LED renk toleransı /
Colour tolerance MacAdam 3

DALI, SwitchDIM ve Acil seçenekleri /
DALI, SwitchDIM and Emergency options

Özellikler / Specifications



Renk Seçenekleri / Colour Options

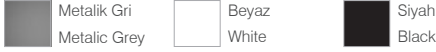

Fotometrik Bilgi / Photometric Data

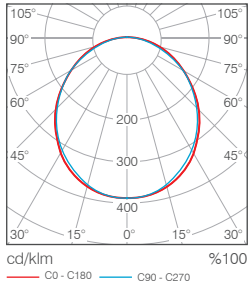

Tavan Bilgi / Ceiling Data

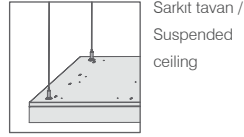

Teknik Çizim / Technical Drawing

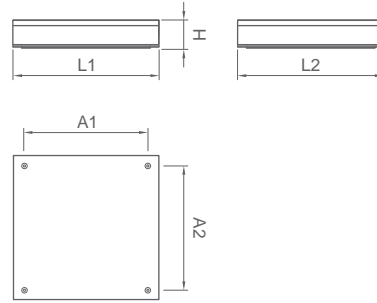

Teknik Bilgi / Technical Data

Güç (W)	Çıkış / Output (lm)	Verimlilik (lm/W)	CRI (Ra)	Renk Sıcaklığı (K)	Ölçüler / Dimensions (mm)	Ağırlık (kg)	Ürün Kodu / Item Code
10,5W	1160	110	>80	3000	A1 320 A2 320 L1 380 L2 380 H 62	2,3	122 0 330 3 112
10,5W	1210	115	>80	4000	A1 320 A2 320 L1 380 L2 380 H 62	2,3	122 0 330 4 112
12,5W	1370	109	>80	3000	A1 320 A2 320 L1 380 L2 380 H 62	2,3	122 0 330 3 111
12,5W	1420	114	>80	4000	A1 320 A2 320 L1 380 L2 380 H 62	2,3	122 0 330 4 111

Ek Kod / Suffix Code

- (100) 1 saat Acil çıkış kiti / 1 hour Emergency gear
- (010) DALI

* Tavan tipini belirtiniz. / Please indicate type of ceiling.

** Askı Takımı / Suspension Kit (802 021)

*** Lütfen daha fazla bilgi için satış temsilcileri ile görüşün. / Please contact for more information.

NEW RIO

Sıva Üstü - Sarkit Armatürler / Surface Mounted - Suspended Luminaires



Farklı renk seçeneği polyester elektrostatik toz boyalı /
Electrostatic polyester powder coated with different color options

Alüminyum çerçeve, sac gövde /
Extruded aluminium frame, sheet metal body

Yüksek geçirgenlikli satine PMMA veya PC opal difüzör /
High diffusion and transmission satin opal PMMA or PC diffuser

Homojen aydınlatma / Uniform illumination

MacAdam 3 LED renk toleransı /
Colour tolerance MacAdam 3

DALI, SwitchDIM ve Acil seçenekleri /
DALI, SwitchDIM and Emergency options

Özellikler / Specifications



Renk Seçenekleri / Colour Options

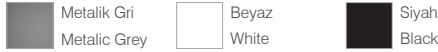

Fotometrik Bilgi / Photometric Data

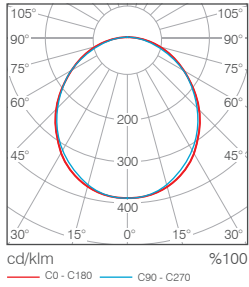

Tavan Bilgi / Ceiling Data

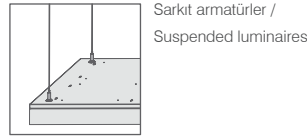

Teknik Çizim / Technical Drawing

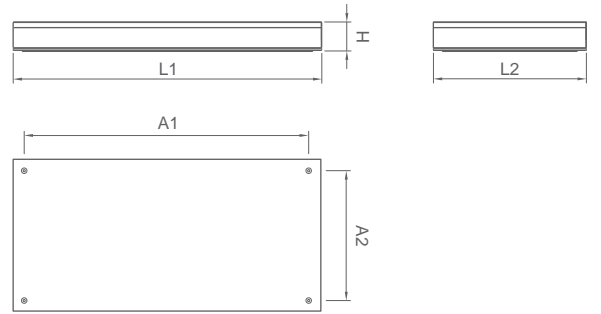

Teknik Bilgi / Technical Data

Güç (W)	Çıkış / Output (lm)	Verimlilik (lm/W)	CRI (Ra)	Renk Sıcaklığı (K)	Ölçüler / Dimensions (mm)	Ağırlık (kg)	Ürün Kodu (Item Code)
17,2W	1960	114	>80	3000	A1 570 A2 320 L1 630 L2 380 H 62	3,6	122 0 360 3 113
17,2W	2050	120	>80	4000	A1 570 A2 320 L1 630 L2 380 H 62	3,6	122 0 360 4 113
21W	2325	111	>80	3000	A1 570 A2 320 L1 630 L2 380 H 62	3,6	122 0 360 3 112
21W	2430	116	>80	4000	A1 570 A2 320 L1 630 L2 380 H 62	3,6	122 0 360 4 112

Ek Kod / Suffix Code

- (100) 1 saat Acil çıkış kiti / 1 hour Emergency gear
- (010) DALI

* Tavan tipini belirtiniz. / Please indicate type of ceiling.

** Askı Takımı / Suspension Kit (802 021)

*** Lütfen daha fazla bilgi için satış temsilcileri ile görüşün. / Please contact for more information.



NEW RIO

Sıva Üstü - Sarkit Armatürler / Surface Mounted - Suspended Luminaires

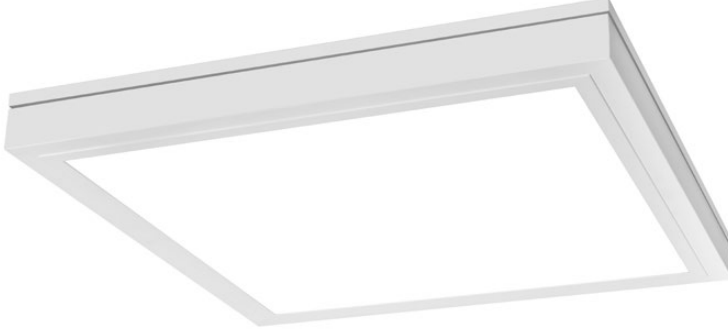

Farklı renk seçeneqli polyester elektrostatik toz boyalı /
Electrostatic polyester powder coated with different color options

Alüminyum çerçeve, sac gövde /
Extruded aluminium frame, sheet metal body

Yüksek geçirgenlikli satine PMMA veya PC opal difüzör /
High diffusion and transmission satin opal PMMA or PC diffuser

Homojen aydınlatma / Uniform illumination

MacAdam 3 LED renk toleransı /
Colour tolerance MacAdam 3

DALI, SwitchDIM ve Acil seçenekleri /
DALI, SwitchDIM and Emergency options

Özellikler / Specifications



Renk Seçenekleri / Colour Options



Fotometrik Bilgi / Photometric Data

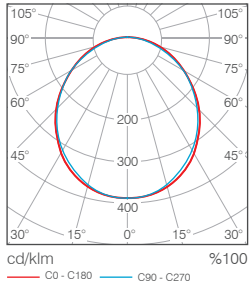

Tavan Bilgi / Ceiling Data

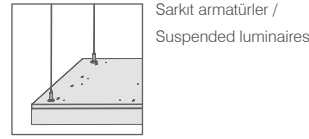

Teknik Çizim / Technical Drawing

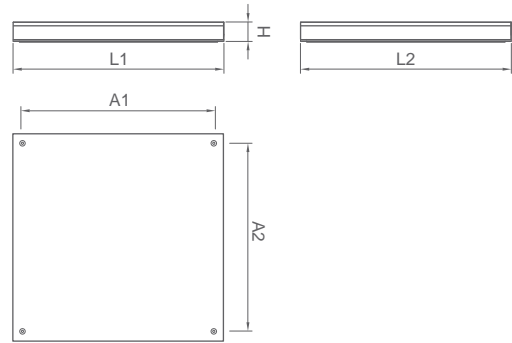

Teknik Bilgi / Technical Data

Güç (W)	Çıkış / Output (lm)	Verimlilik (lm/W)	CRI (Ra)	Renk Sıcaklığı (K)	Ölçüler / Dimensions (mm)					Ağırlık (kg)	Ürün Kodu / Item Code
					A1	A2	L1	L2	H		
34,4W	3920	114	>80	3000	570	570	630	630	62	6,2	122 0 660 3 113
34,4W	4100	120	>80	4000	570	570	630	630	62	6,2	122 0 660 4 113
42W	4650	111	>80	3000	570	570	630	630	62	6,2	122 0 660 3 112
42W	4860	116	>80	4000	570	570	630	630	62	6,2	122 0 660 4 112

Ek Kod / Suffix Code

- (100) 1 saat Acil çıkış kiti / 1 hour Emergency gear
- (010) DALI

* Tavan tipini belirtiniz. / Please indicate type of ceiling.

** Askı Takımı / Suspension Kit (802 021)

*** Lütfen daha fazla bilgi için satış temsilcileri ile görüşün. / Please contact for more information.



NEW RIO Askı Takımı Aksesuarları / Suspension Accessories For NEW RIO Luminaires

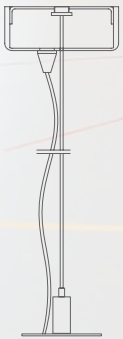

(802 021)
Askı Takımı /
Suspension Kit



(802 022)
Askı Teli /
Wire Suspension



Kablo /
Cable

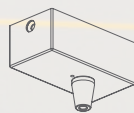

Rozans /
Ceiling Cup

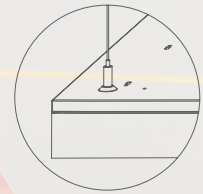
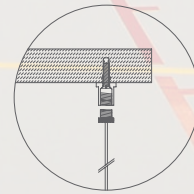

NEW RIO

Sıva Üstü - Sarkit Armatürler / Surface Mounted - Suspended Luminaires



Farklı renk seçeneqli polyester elektrostatik toz boyalı /
Electrostatic polyester powder coated with different color options

Alüminyum çerçeve, sac gövde /
Extruded aluminium frame, sheet metal body

Yüksek geçirgenlikli satine PMMA veya PC opal difüzör /
High diffusion and transmission satin opal PMMA or PC diffuser

Homojen aydınlatma / Uniform illumination

MacAdam 3 LED renk toleransı /
Colour tolerance MacAdam 3

DALI, SwitchDIM ve Acil seçenekleri /
DALI, SwitchDIM and Emergency options

Özellikler / Specifications



Renk Seçenekleri / Colour Options

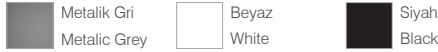

Fotometrik Bilgi / Photometric Data

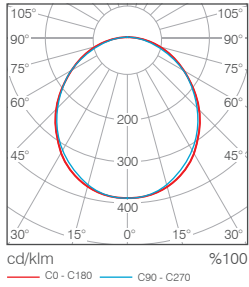

Tavan Bilgi / Ceiling Data

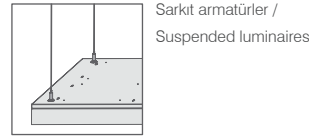

Teknik Çizim / Technical Drawing

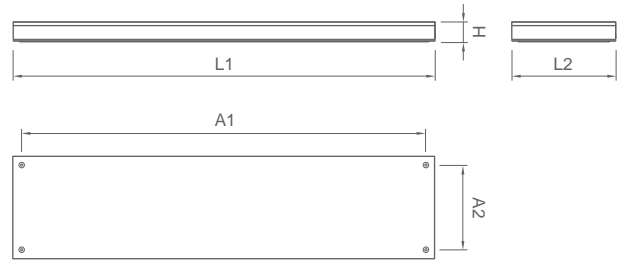

Teknik Bilgi / Technical Data

Güç (W)	Çıkış / Output (lm)	Verimlilik (lm/W)	CRI (Ra)	Renk Sıcaklığı (K)	Ölçüler / Dimensions (mm)	Ağırlık (kg)	Ürün Kodu / Item Code
34,4W	3920	114	>80	3000	A1 1070 A2 320 L1 1130 L2 380 H 62	11,4	122 0 312 3 113
34,4W	4100	120	>80	4000	A1 1070 A2 320 L1 1130 L2 380 H 62	11,4	122 0 312 4 113
42W	4650	111	>80	3000	A1 1070 A2 320 L1 1130 L2 380 H 62	11,4	122 0 312 3 112
42W	4860	116	>80	4000	A1 1070 A2 320 L1 1130 L2 380 H 62	11,4	122 0 312 4 112

Ek Kod / Suffix Code

- (100) 1 saat Acil çıkış kiti / 1 hour Emergency gear
- (010) DALI

* Tavan tipini belirtiniz. / Please indicate type of ceiling.

** Askı Takımı / Suspension Kit (802 021)

*** Lütfen daha fazla bilgi için satış temsilcileri ile görüşün. / Please contact for more information.



CLEAN RIO

Sıva Altı Armatürler / Recessed Luminaires



Polyester elektrostatik toz boyalı /
Electrostatic polyester powder coated

IP65 çerçeve ve sac gövde / IP65 frame and sheet metal body

Yüksek geçirgenlikli satine PMMA veya PC opal difüzör /
High diffusion and transmission satin opal PMMA or PC diffuser

Homojen aydınlatma / Uniform illumination

MacAdam 3 LED renk toleransı /
Colour tolerance MacAdam 3

DALI, SwitchDIM seçenekleri /
DALI, SwitchDIM options

Özellikler / Specifications



Renk Seçenekleri / Colour Options



Beyaz
White

Fotometrik Bilgi / Photometric Data

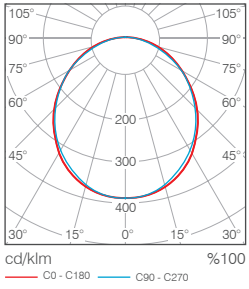

Tavan Bilgi / Ceiling Data

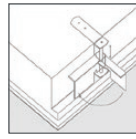

T15 veya T25 tavanlar /
T15 or T25 exposed T

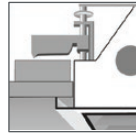

Alçı tavanlar /
Plaster board ceilings

Teknik Çizim / Technical Drawing

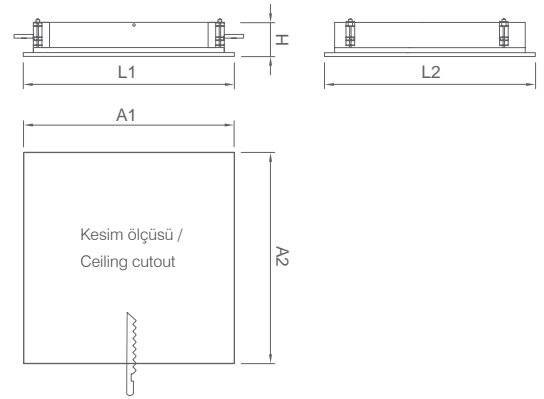

Teknik Bilgi / Technical Data

Güç (W)	Çıkış / Output (lm)	Verimlilik (lm/W)	CRI (Ra)	Renk Sıcaklığı (K)	Ölçüler / Dimensions (mm)	Ağırlık (kg)	Ürün Kodu (Item Code)
34,4W	3920	114	>80	3000	A1 572 A2 572 L1 595 L2 595 H 82	6,7	131 0 660 3 113
34,4W	4100	120	>80	4000	A1 572 A2 572 L1 595 L2 595 H 82	6,7	131 0 660 4 113
42W	4650	111	>80	3000	A1 572 A2 572 L1 595 L2 595 H 82	6,7	131 0 660 3 112
42W	4860	116	>80	4000	A1 572 A2 572 L1 595 L2 595 H 82	6,7	131 0 660 4 112

Ek Kod / Suffix Code

- (010) DALI



ROUND RIO

Sıva Altı Armatürler / Recessed Luminaires

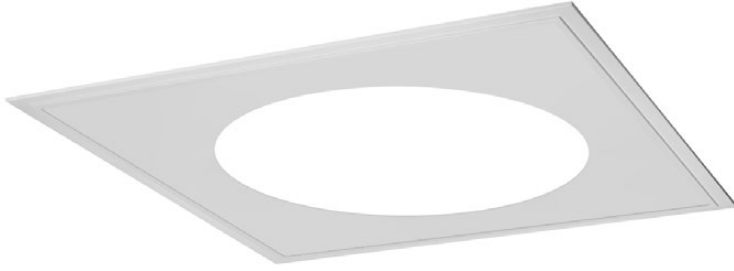

Polyester elektrostatik toz boyalı /
Electrostatic polyester powder coated

Alüminyum çerçeve, sac gövde /
Extruded aluminium frame, sheet metal body

Yüksek geçirgenlikli satine PMMA veya PC opal difüzör /
High diffusion and transmission satin opal PMMA or PC diffuser

Homojen aydınlatma / Uniform illumination

MacAdam 3 LED renk toleransı /
Colour tolerance MacAdam 3

DALI, SwitchDIM ve Acil seçenekleri /
DALI, SwitchDIM and Emergency options

Özellikler / Specifications



Renk Seçenekleri / Colour Options



Fotometrik Bilgi / Photometric Data

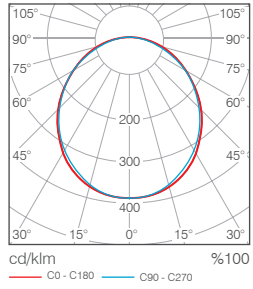

Tavan Bilgi / Ceiling Data

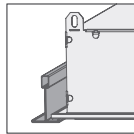

T15 veya T25 tavanlar /
T15 or T25 exposed T

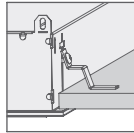

Alçı tavanlar /
Plaster board ceilings

Teknik Çizim / Technical Drawing

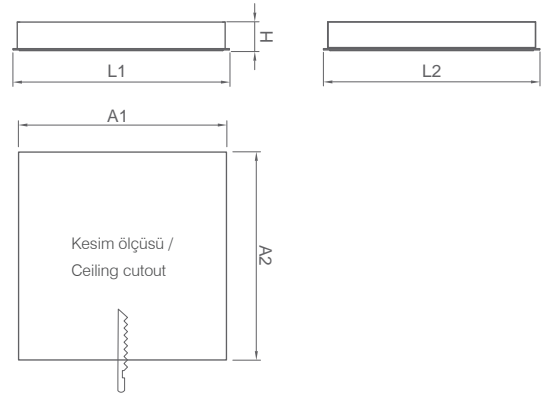

Teknik Bilgi / Technical Data

Güç (W)	Çıkış / Output (lm)	Verimlilik (lm/W)	CRI (Ra)	Renk Sıcaklığı (K)	Ölçüler / Dimensions (mm)	Ağırlık (kg)	Ürün Kodu (Item Code)
26W	3000	115	>80	3000	A1 575 A2 575 L1 595 L2 595 H 73	5,7	141 0 001 3 257
26W	3150	121	>80	4000	A1 575 A2 575 L1 595 L2 595 H 73	5,7	141 0 001 4 257
42W	4300	102	>80	3000	A1 575 A2 575 L1 595 L2 595 H 73	5,7	141 0 001 3 259
42W	4500	107	>80	4000	A1 575 A2 575 L1 595 L2 595 H 73	5,7	141 0 001 4 259

Ek Kod / Suffix Code

- (300) 3 saat Acil çıkış kiti / 3 hours Emergency gear
- (010) DALI

* Tavan tipini belirtiniz. / Please indicate type of ceiling.

** L demiri askı takımı, alçı tavanlar için / L brackets for plaster board ceilings

*** Lütfen daha fazla bilgi için satış temsilcileri ile görüşün. / Please contact for more information.



VEKSAN Aydınlatma San. ve Tic A.Ş.
Lighting Industry & Trade Co. Inc.

Fabrika: Eskişehir Organize Sanayi Bölgesi (EOSB)

21.Cadde No:5, Eskişehir / TR

T +90 (222) 236 8486 (pbx)

F +90 (222) 236 8492

Ofis: Bahçeşehir 1. Kısım Mah. Sığırcık Sk.

Badem 5 Villa:10 Başakşehir, İstanbul/ TR

T +90 (212) 798 3333 (pbx)

F +90 (212) 798 3338

Showroom: Meşrutiyet Cad. Evliya Çelebi Mah.

Nur Ap. No:98 K:2 D:6 Beyoğlu, İstanbul / TR

T +90 (212) 292 4481 (pbx)

F +90 (212) 292 4476

veksan@veksan.com

www.veksan.com